

Båtsystem



A better boating experience

We at Båtsystem are delighted to present our new catalogue with loads of new products, driven by clients' ideas as well as from our own deep love for boating. Developing and producing boat equipment to achieve a more enjoyable time at sea is a commitment and we try hard to target every member of the family, irrespectively of age, also including your pet dog.

Our first product range is thus targeting this highly essential need: ladders, gangways, lifting devices, bow and stern platforms are all examples for **the easy way on board**. However, it doesn't end there! Many products feature a second task as well. For example, bowsprits do not only provide a sturdy platform and the place to fit your built-in telescopic or hanged on ladder. At the same time, it acts as the perfect place to stow your anchor or to attach your gennaker or your Code-0 sail.

Our second product range is within creating **a pleasant light onboard**. We create a welcoming and homey atmosphere by means of LED lighting. The boat feels wider, more spacious, and roomier if indirect lighting defines the edges of the cabin. Adding courtesy lights create special effects on deck, under deck or under water and is a great way to create a pleasant atmosphere onboard.

We hope you will enjoy the catalogue and that some of our products will help you achieve a better boating experience.

Mattias Becklund

CEO, Båtsystem



www.batsystem.com

Båtsystem AB, Traneredsvägen 112, S-426 53 Västra Frölunda, Sweden
Tel: +46 31 69 03 80, info@batsystem.se



A young child in a blue and white striped jacket is climbing a stainless steel ladder on the deck of a boat. The child is seen from the side, reaching up to the handrails. The background shows a clear blue sky and a body of water.

The easy way on board

Index

BOARDING EQUIPMENT

The easy way on board	4 - 5
Ladders	6 - 15
Bowsprits	16 - 25
Bowsprit accessories	28 - 29
Stern Platforms	30 - 36
Accessories for easy boarding	37
Lifting Devices	38 - 43
Windlass Systems	44 - 47
Fittings and spare parts	48
Gallery	49

LIGHTING EQUIPMENT

The pleasant light onboard	54 - 55
Lighting Design	56 - 57
Indirect Lighting	58 - 61
Cabin Lights	62 - 65
Smart downlighting	66 - 67
Downlights	68 - 73
Courtesy Lights	74 - 75
Underwater Lights	76 - 77
Functional Lights	78 - 82
Navlights	83
Light Switches	84 - 87
Light Sources	88 - 89
Transformers	90

JEFA* 26

POWERIL* 27

ZIPWAKE* 50 - 51

PREBIT* 91

* Only distributed in Sweden.

Båtsystem AB is not responsible for typographical errors and deviations concerning products and specifications in the catalog.

The easy way on board

Båtsystem is a specialist when it comes to getting you and your equipment on and off the boat. We have ladders and accessories for all situations for the whole family, old and young and the dog, including the dinghy and its outboard motor.

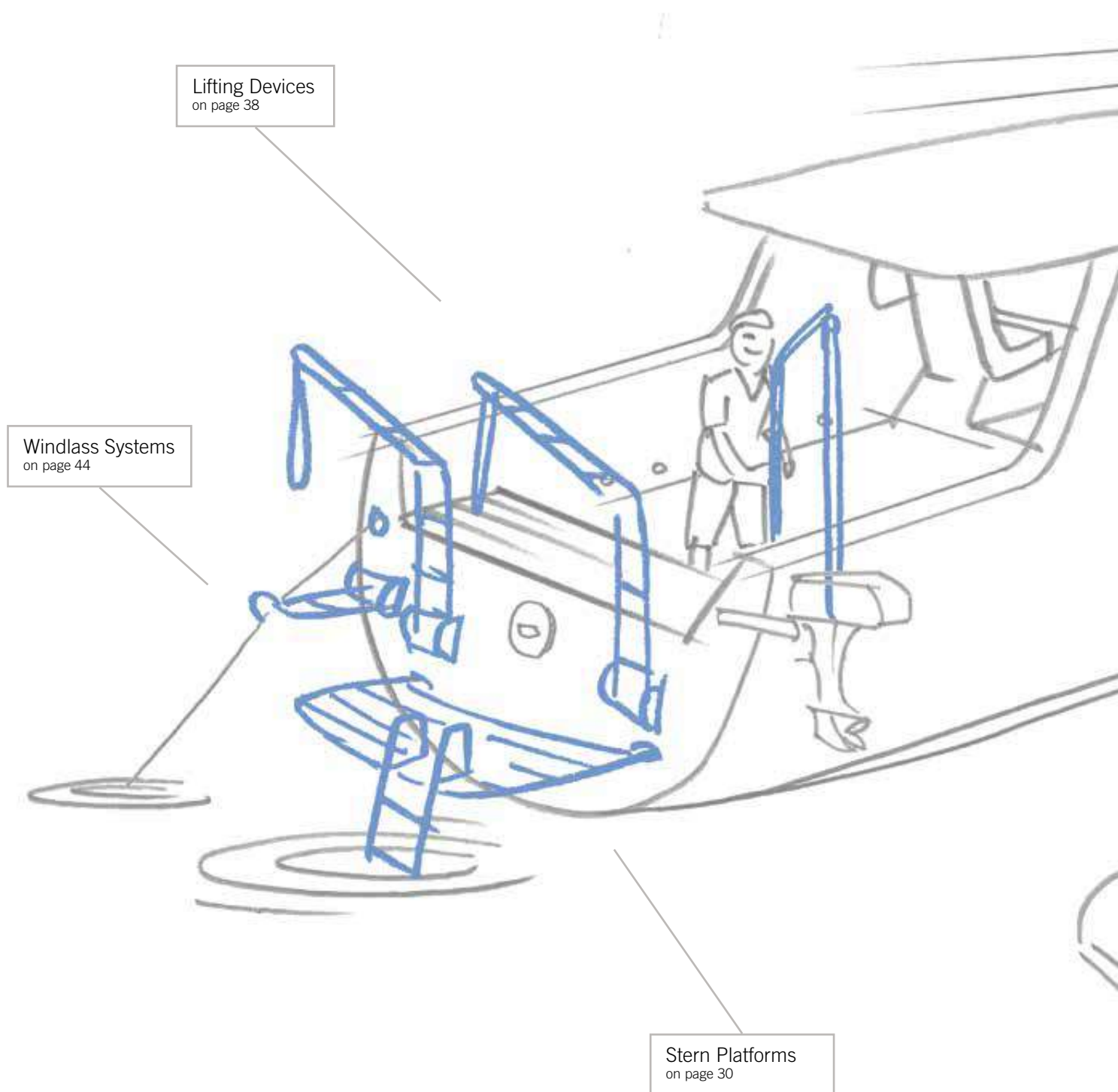

Bowsprits
on page 16

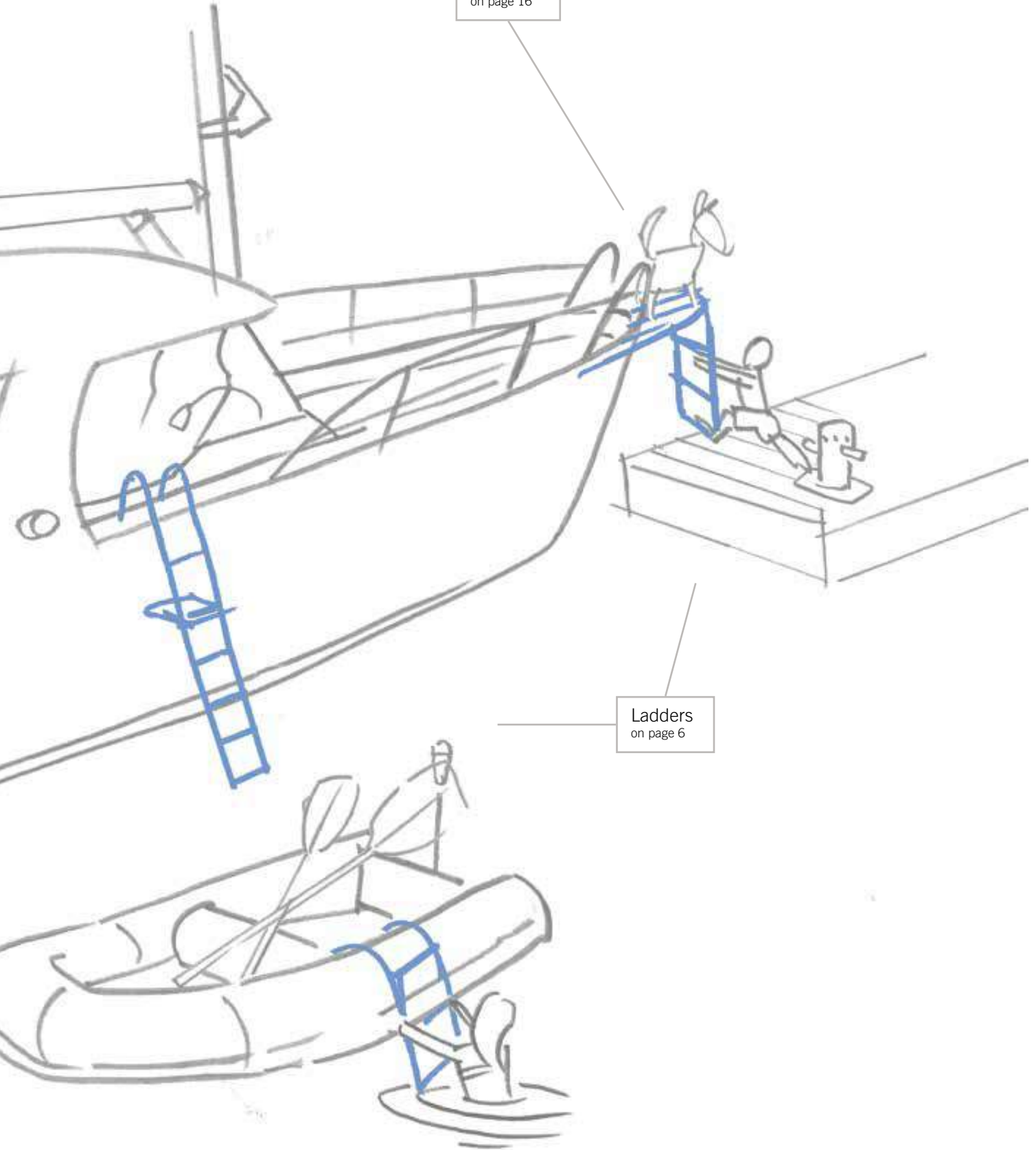

Ladders
on page 6



Ladders

A ladder will get you there

A ladder mounted to your boat is a must, whether you prefer it at the stern, onto the bathing platform or the bowsprit. Most important is that it's easily accessible from the water, in case of an unintentional plunge. But it's not only a matter of safety, it's also about convenience, accessibility and the freedom to get on land wherever you like. In other words – getting the most out of your boating experience.





RIB

Ladders specifically designed for RIB boats.



SIDE

When boarding from the side with a RIB as well as from the bridge.



TELESCOPIC

Telescopic ladders and ladders in casing to minimize space.



HOOK

For bow and bowsprit. Easy to hook on and off.



BOW

For fast and easy mounting on bow or pulpit.



SAFETY AND BATHING (MOB)

Access all the way from water to deck.



Ladders

RIB LADDER



Ladder for RIB that takes you all the way up.

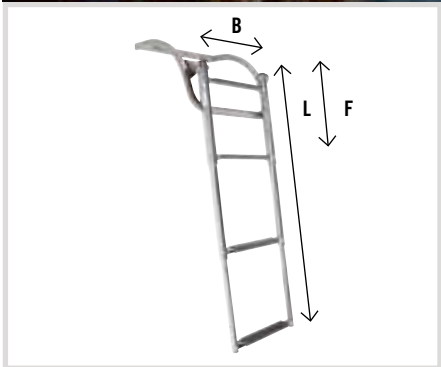

RIB400

RIB500

Art	L (mm)	F (mm)	B (mm)	Tube diameter, boat (mm)	Folding
RIB400	868	375	340	400	Telescopic
RIB500	1160	410	350	500	Telescopic



Hang mounting
Hung on the tube and tightened with safety bands.



Comfortable steps



Hook fittings
The ladder is attached to the hull with hook fitting.



Key hole fitting
Optional fittings.



The RIB ladder is resting on the boat's tube and is secured with two straps.

SIDE LADDER

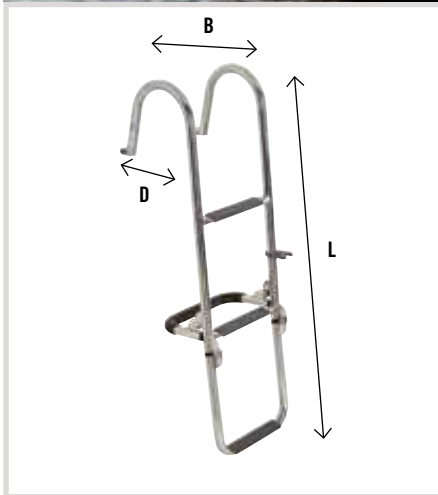

A well built solid ladder turns the act of getting on- or off your boat from the side into a safe and effortless task.



Sturdy handles
For extra good grip.



Foldable
the last step on SL95 and the three last steps on SL150 are foldable.



Hook fittings
Easy to attach and detach.



Soft struts
Foldable.



SL65

SL95

SL150

Art	L (mm)	B (mm)	D (mm)	c/c mm	Steps	
SL65	640	268	189	265	2	
SL95	950	268	189	265	3	Available with teak steps (SL95T)
SL150	1530	280	245	265	6	



Ladders

TELESCOPIC LADDER IN CASING - STANDARD



Telescopic ladder in casing, for bowsprit or bathing platform. The ladder expands in two, three or four steps and is easily locked.

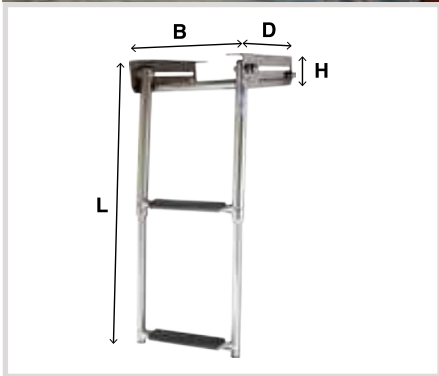

Locking
Smart locking mechanism.



Comfortable steps



Foldable
Folds down under platform or bowsprit.



Fitting
Smooth fittings for BT-ladders.



BKT72

BKT73

BKT74

BT70

BT115

BT145

BKB73

Art	L (mm)	B (mm)	D (mm)	H (mm)	Step	Folding
BKT72-250	600	250	300	65	2 Plastic	Casing/telescope
BKT73-250	880	250	300	65	3 Plastic	Casing/telescope
BKT72	600	285	300	65	2 Plastic	Casing/telescope
BKT73	880	290	300	65	3 Plastic	Casing/telescope
BKT73T	880	290	300	65	3 Teak	Casing/telescope
BKT74	1160	310	320	80	4 Plastic	Casing/telescope
BKT74T	1160	310	320	80	4 Teak	Casing/telescope
BT70	880	300	110	-	3 Plastic	Telescope
BT115	1160	300	110	-	4 Plastic	Telescope
BT145	1450	310	140	-	5 Plastic	Telescope
BKB73	880	340 (box)	490 (box)	50 (box)	3 Plastic	Telescopic in box
BKB74	1160	340 (box)	490 (box)	50 (box)	4 Plastic	Telescopic in box



TELESCOPIC LADDER IN CASING - SPECIAL



Telescopic ladder in casing for the Performance bowsprit PB120/PB140 with larger anchors.

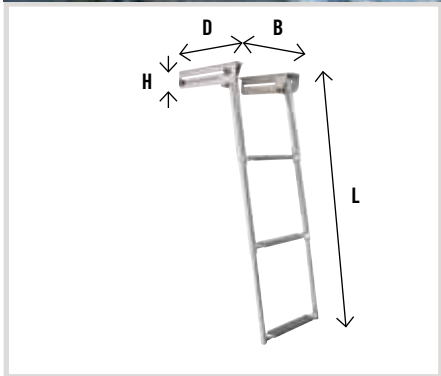

Locking
Smart locking mechanism.



Comfortable steps



Foldable
Folds down under bowsprit.



No strut
More space for larger anchor.

Art	L (mm)	B (mm)	D (mm)	H (mm)	Steps	Folding
BKT73A	880	295	300	65	3	Casing/telescope

TELESCOPIC LADDER IN CASING - SPECIAL



Telescopic ladder in casing for bowsprit and bathing platform. Ropes for pulling up and lowering down.

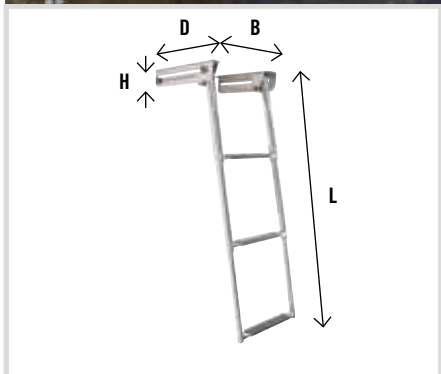

Rope control
Ropes for raising and folding.



Locking
Smart locking mechanism.



Comfortable steps



Foldable
Folds down under platform or bowsprit. Rounded design to match the bowsprit.

Art	L (mm)	B (mm)	D (mm)	H (mm)	Steps	Folding
BKR93	880	300	360	65	3	Casing/telescope - rope controlled

Ladders

HOOK LADDER



Ladders for bowsprit, with sturdy handles. Hook onto bowsprit or on deck.

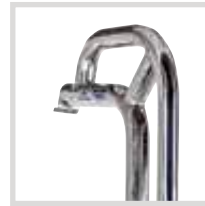
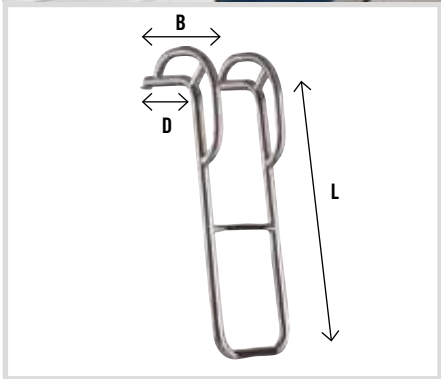

Sturdy handles
For extra good grip.



Foldable
Last step is telescopic on 4 step ladders.



Hook fittings
Easy to attach and detach.



Safety band
Secures the ladder from falling into the water.



Support
BU80F has support for extra narrow bows.



Foldable
New hinge design on the ladders.

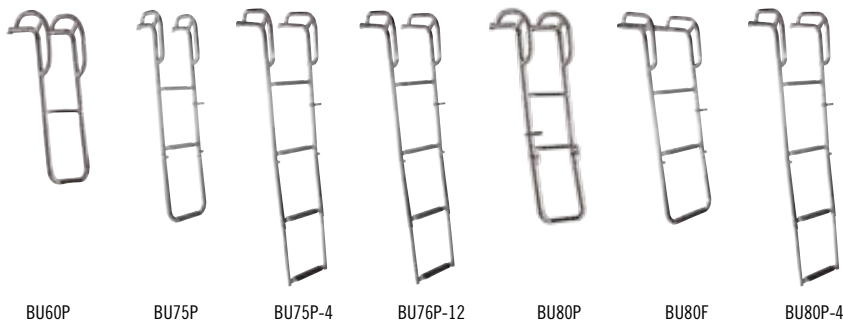

Art	L (mm)	B (mm)	D (mm)	c/c mm	Steps	
BU60P	615	180	130	175	2	Aluminium
BU75P	900	220	130	200	3	
BU75P-4	1200	220	130	200	4	Last step telescopic
BU76P-12	1200	230	220	230	4	Last step telescopic
BU80P	900	290	222	265	3	
BU80P-4	1200	290	222	265	4	Last step telescopic
BU80F	900	290	222	140	3	

BOW LADDER



Ladder for sailing yachts and power-boats. The ladder can be mounted onto pulpit, bowsprit or directly at the bow by using extra fittings.

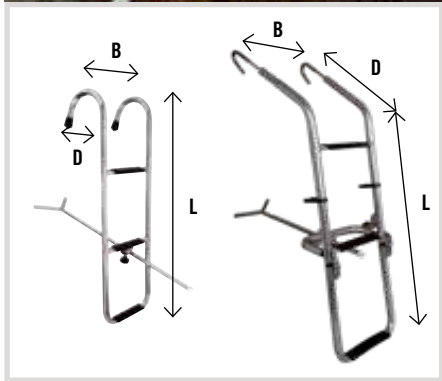

Quick brackets
Easy to attach and detach.



Foldable
Easy to stow.



Stem strut
Adjustable.



Aluminium
Two ladders in lightweight aluminium.



Bag
Convenient storing.



Safety band
Secures the ladder from falling into the water.



Fitting P1066 for optional mounting.



ST130AL is designed to fit a blunt stem, or a boat with stem anchor. The topmost step has been removed, and the upper edge is broadened, to make room for the anchor. The last step is foldable.



Art	L (mm)	B (mm)	D (mm)	Length folded	Strut (mm)	Steps	Material	Fitting
ST90	900	265	-	900	0-750	3	AiSi316 steel	Keyhole fitting
ST95	925	250-300	-	680	350-1000	3	AiSi316 steel	Hook
ST125AL	1240	250-300	-	740	350-1000	4	Aluminium	Hook
ST130	1240	350-450	-	740	350-1000	3	AiSi316 steel	Hook
ST130AL	1240	350-450	-	740	350-1000	3	Aluminium	Hook
ST135	740	320-450	550	440	100-350	3	AiSi316 steel	Hook
ST110SN	1050	290	212	780	350-1000	3	AiSi316 steel	Keyhole fitting

Ladders

SAFETY AND BATHING (MOB)

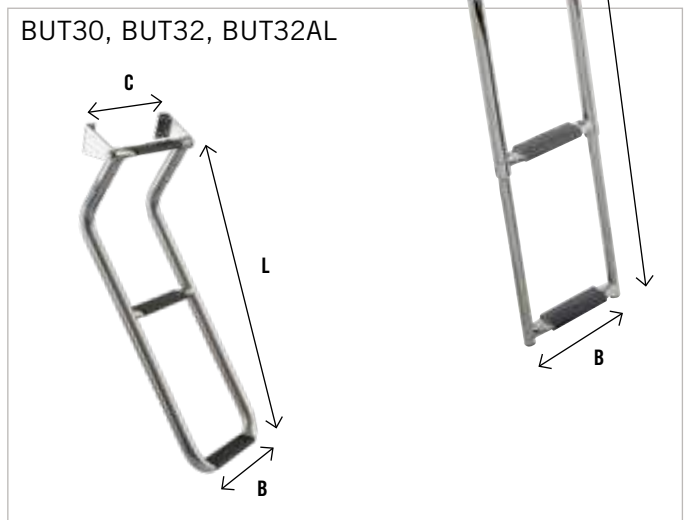
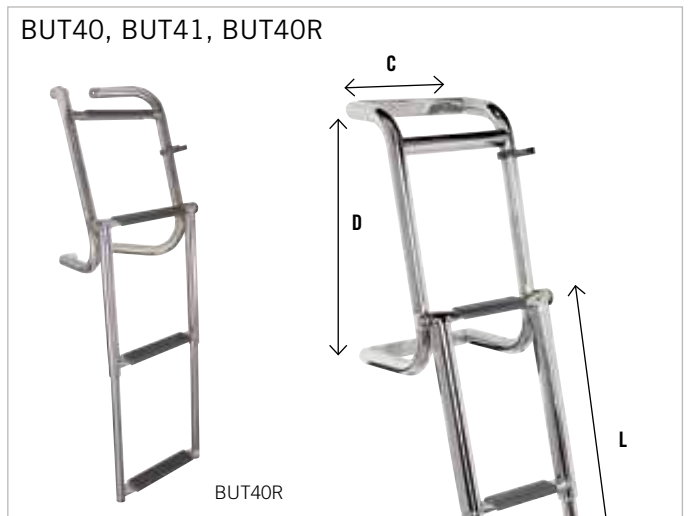

Art	L (mm)	B (mm)	C c/c (mm)	D c/c (mm)	Length folded (mm)	Strut (mm)	Steps	Folding	
BT72-180	1115	210	90	200	402	70	4	Telescope	
BT72-4	1160	300	150	175	370	70	4	Telescope	
BUT30	400	225	200	-	400	-	2	Folding	
BUT32	600	220	200	-	-	-	3	Folding	
BUT32AL	600	220	200	-	-	-	3	Folding	Aluminium ladder
BUT40	590	230	125	360	360	-	4	Telescope/Folding	
BUT41	850	230	125	360	360	-	5	Telescope/Folding	
BUT40R	880	255	90	385	385	-	4	Telescope/Folding	
BUT55	1185	210	200	470	550	110	5	Telescope/Folding	
BUT55F	1185	210	200	470	550	290-580	5	Telescope/Folding	

SAFETY AND BATHING (BATHING)



Bathing ladder with sturdy grips and universal fittings. Foot friendly steps.

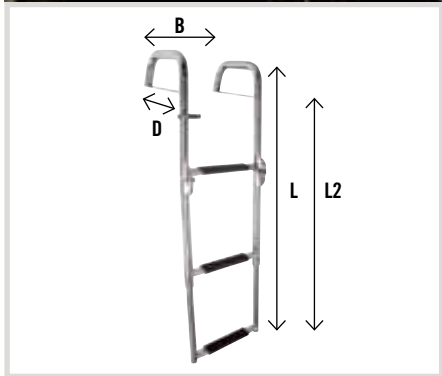

Sturdy handles
For extra good grip.



Foldable
Telescopic.

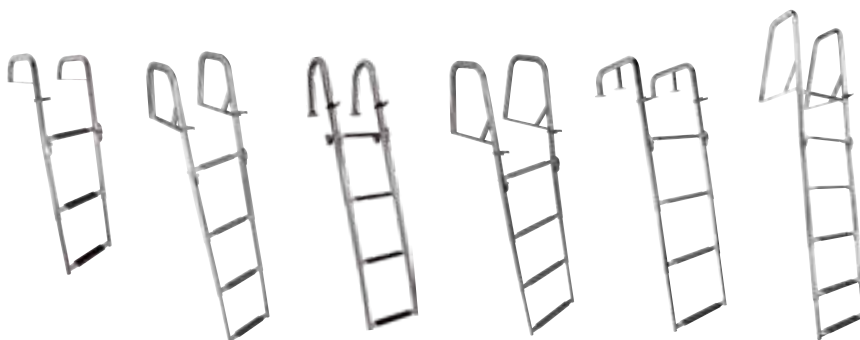

BUT25

BUT45

BUT45U

BUT47

BUT49

BUT50

Art	L (mm)	B (mm)	D (mm)	Length folded	Steps	Handle height (mm)	c/c mm	Strut (mm)
BUT25	928	285	235	358	3	100	255	-
BUT45	1300	290	260	453	4	250	255	-
BUT45U	1300	287	238	453	4	250	255	80
BUT47	1420	382	343	554	4	370	350	-
BUT49	1300	382	350	423	4	130	350	-

Art	L (mm)	B (mm)	D (mm)	L2(mm)	Steps	Handle height (mm)	c/c mm
BUT50	1955	400	361	1455	6	500	362
BUT60	2523	400	361	2023	8	500	362



Bowsprits

Extend your boating experience

A bowsprit not only enhances the looks and quality of your boat. It also helps you achieve a better boating experience. Use the winds' full potential with a gennaker or Code-0 sail, get ashore on every possible and impossible place, and get easily onboard – even when your legs are too short, or too tired.





POWERBOAT

Bowsprits that fit almost any powerboat. Could well be combined with Båtsystem's ladders and pulpits for maximum accessibility and safety.



PERFORMANCE

Performance is a series of bowsprits for sailing yacht and Code-0 sailing. Developed with a focus on design, functionality, and sailing performance.



RACE

Racing bowsprits built with sailing performance in focus. Designed for Code-0 and gennaker sails. Can be supplemented with a bow ladder.



STREAMLINE

An integrated bowsprit for Code-0 sailing, especially designed for modern sailing yachts



COMFORT

Bowsprits with a welded ladder, for maximum stability and accessibility.



CLASSIC

Classic gennaker bowsprits for sailboats. Facilitating getting on - and off the boat.



SHAPE

Bowsprits with a curved shape which gives wider tread and still a nice attachment.



Bowsprits - powerboat

FOR POWERBOAT < 25 FT



Bowsprit designed for powerboats 16-25 feet. Could well be combined with Båtsystems ladders and pulpits, for maximum accessibility and safety.

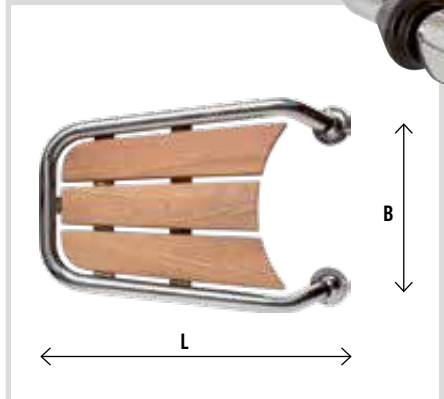

Ladder
Ladder in casing or hook ladder as an option.

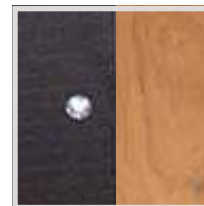

Blackline/Teak
Choose between Blackline or Teak on MP55 and MPA55



Angled stay
Easy to mount.



Anchor roller
Integrated on MPA55.



MP40



MP55BL / MP55



MPA55BL / MPA55

Art	L (mm)	B (mm)	Tube (mm)	For boats	Step surface	Fitting ladder	Fitting pulpit
MP40	400	380	25	16'-22'	Blackline	BU60P	-
MP55	550	360	32	18'-25'	Teak	BKT72-250, BKT73-250, BU60P	PP350
MP55BL	550	360	32	18'-25'	Blackline	BKT72-250, BKT73-250, BU60P	PP350
MPA55	550	360	32	18'-25'	Teak	BU60P	PP350
MPA55BL	550	360	32	18'-25'	Blackline	BU60P	PP350

FOR POWERBOAT 25-55 FT



Bowsprit for powerboats between 25 and 55 feet. Can be mounted over existing anchor roller. Can be combined with Båtsystem's ladders and pulpits for comfort and safety.

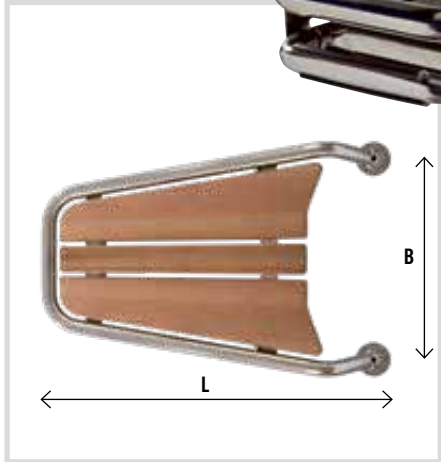

Ladder
Ladder in casing or hook ladder as an option.

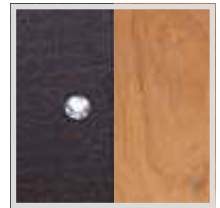

Blackline/Teak
Choose between Blackline or Teak on MP55.



Anchor roller
Integrated in MPA75.



Existing anchor
Designed also for mounting on existing anchor holder.



MP75BL / MP75

MPA75BL / MPA75

MP90BL / MP90

MP100BL / MP100



Art	L (mm)	B (mm)	Tube (mm)	For boats	Step surface	Fitting	Anchor roller	Rec. Anchor	Fitting ladder	Fitting pulpit
MP75	700	480	32	25'-40'	Teak	Universal	-		BKT72, BKT73, BKT73T, BU75P, BU75P-4	PP350
MP75BL	700	480	32	25'-40'	Blackline	Universal	-		BKT72, BKT73, BKT73T, BU75P, BU75P-4	PP350
MPA75	700	480	32	25'-40'	Teak	Universal	P1301	15 kg	BKT72, BKT73, BKT73T, BU75P, BU75P-4	PP350
MPA75BL	700	480	32	25'-40'	Blackline	Universal	P1301	15 kg	BKT72, BKT73, BKT73T, BU75P, BU75P-4	PP350
MP90	850	440	32	32'-45'	Teak	Universal	-		BKT73, BKT73T, BU80P, BU80P-4	PPK500
MP90BL	850	440	32	32'-45'	Blackline	Universal	-		BKT73, BKT73T, BU80P, BU80P-4	PPK500
MP100	1150	560	42	40'-55'	Teak	Evolution	-		BKT73, BKT73T, BU80P, BU80P-4	PP350, PPK500
MP100BL	1150	560	42	40'-55'	Blackline	Evolution	-		BKT73, BKT73T, BU80P, BU80P-4	PP350, PPK500

Bowsprits - sailing yacht

PERFORMANCE



The Performance Series consists of bowsprits for sailing yachts. The special emphasis is put on design, functionality, and performance. The bowsprits are perfect for sailors wanting to get the most out of modern Code- or Gennakersailing. The adjustable upper anchor roller is suitable for most frequently used anchors on the market, up to 20 or 30 kg. The bowsprit also allows for a combination of a 20 kg anchor and a telescopic ladder in casing.

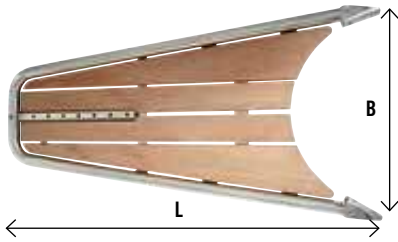

Code-0
Standard, adjustable strut.



Gennaker fitting
Standard.



Ladder
Ladder in casing or hook ladder as an option.



Anchor holder
Adjustable.



Blackline/Teak
Choose between Blackline or Teak.



End fittings
New design with flush mounted bolts.



The PB120 bowsprit allows for the combination of a 20 kg anchor with the BKT73A telescopic ladder in casing.



PB105BL / PB105



PB120BL / PB120



PB140BL / PB140



PB150BL / PB150

Art	L (mm)	B (mm)	Tube (mm)	For boats	For gennaker	Step surface	Std. anchor roller	Rec. anchor	Code-0 Load	Fitting ladder	Fitting pulpit
PB105	1050	435 +/-50	32	26'-33'	80 m2	Teak	P1308*	15 kg	Max 1500 kg	BKT73, BKT73T, BU75P, BU75P-4	PPK600
PB105BL	1050	435 +/-50	32	26'-33'	80 m2	Blackline	P1308*	15 kg	Max 1500 kg	BKT73, BKT73T, BU75P, BU75P-4	PPK600
PB120	1180	532 +/-50	42	32'-42'	115 m2	Teak	P1308*	20 kg	Max 2500 kg	BKT73A, BU76P-12	PPK600, PPK900
PB120BL	1180	532 +/-50	42	32'-42'	115 m2	Blackline	P1308*	20 kg	Max 2500 kg	BKT73A, BU76P-12	PPK600, PPK900
PB140	1400	590	42	36'-47'	130 m2	Teak	P1306*	30 kg	Max 2500 kg	BU76P-12, BKT73A	PPK800, PPK900
PB140BL	1400	590	42	36'-47'	130 m2	Blackline	P1306*	30 kg	Max 2500 kg	BU76P-12, BKT73A	PPK800, PPK900
PB150	1500	630	50	45'-55'	150 m2	Teak	-**	-**	Max 2500 kg	BU80P, BU80P-4	PPK800, PPK900
PB150BL	1500	630	50	45'-55'	150 m2	Blackline	-**	-**	Max 2500 kg	BU80P, BU80P-4	PPK800, PPK900

* Available without anchor roller. ** Available with anchor roller P1307 for 30 kg or P1306 for 50 kg.

RACE



The Race bowsprit are developed with sailing performance in focus. Designed for Code-0 and gennaker sails and with a stripped-down racing design, it's the perfect option for sailors who aim for an ultimate sailing experience, still enjoying full comfort and security while getting onboard or off the boat.

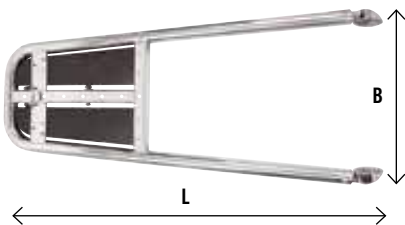

RACE80



RACE100



Code-0
Standard, adjustable strut.



Evolution fitting
Elegant.



Strut
Adjustable in length and position to cope with heavier loads.



Gennaker fitting
Standard.

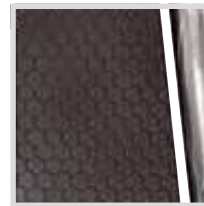

Blackline



Ladder
Hook ladder as an option.



When sailing with a Code-0 sail, huge triaxial forces attack both horizontally and vertically. A removable or retractable bowsprit is not designed to cope with these forces. Code-0 sails require a much more sturdy tripodal construction, that still is light and facilitates a quick and efficient attachment of the sail.

Art	L (mm)	B (mm)	Tube (mm)	For boats	For gennaker	Step surface	Code-0 Load	Fitting ladder
RACE80	800	330	32	26'-32'	80 m2	Blackline	Max 1500 kg	BU75P, BU75P-4
RACE100	1000	390	42	30'-42'	130 m2	Blackline	Max 2500 kg	BU75P, BU75P-4

Bowsprits - sailing yacht

STREAMLINE



Streamline bowsprit is an integrated bowsprit for Code-0 sailing, especially designed for modern sailing yachts with a vertical or close to a vertical bow. Comes with a complete Code-0 kit and fittings for gennaker up to 110 m2. The bowsprit comes with blackline steps as standard but is also available with Flexiteak; weathered or teak.



Code-0
Standard, adjustable
strut.



Ladder
Ladder in casing or hook ladder as an option.

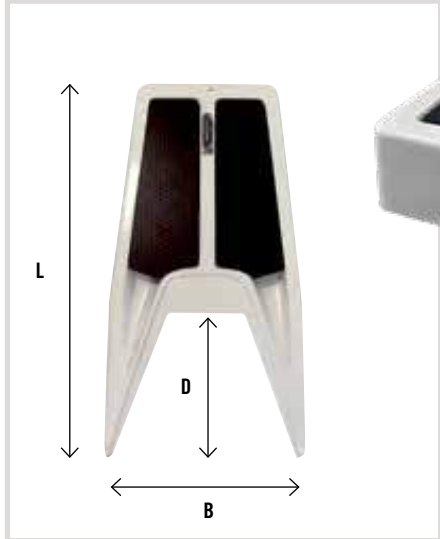

Blackline/Teak/Weathered
Choose between Blackline, Teak or Weathered teak.



STR80BL / STR80TE / STR80WE



STR110BL / STR110TE / STR110WE



Art	L (mm)	B (mm)	D (mm)	For boats	For gennaker	Step surface	Code-0 Load	Anchor roller	Rec Anchor	Fitting ladder
STR80BL	800	395	375	up to 40'	110 m2	Blackline	Max 1500 kg	-	-	BKT73-250, BU75P
STR80TE	800	395	375	up to 40'	110 m2	Teak	Max 1500 kg	-	-	BKT73-250, BU75P
STR80WE	800	395	375	up to 40'	110 m2	Weathered teak	Max 1500 kg	-	-	BKT73-250, BU75P
STR110BL	1008	520	500	up to 47'	150 m2	Blackline	Max 2500 kg	P1306*	25 kg**	BKT73, BU75P
STR110TE	1008	520	500	up to 47'	150 m2	Teak	Max 2500 kg	P1306*	25 kg**	BKT73, BU75P
STR110WE	1008	520	500	up to 47'	150 m2	Weathered teak	Max 2500 kg	P1306*	25 kg**	BKT73, BU75P

*Optional. Can be added. ** with P1306.

CHOOSING BOWSPRIT FOR CODE-0



A furler and a Code 0-sail are not enough for a complete Code solution. A sturdy attachment for the furler to the boat is also needed. The idea behind Båtsystem's solution is a bowsprit designed to take care of the strong forces that occur when sailing with Code.

Which bowsprit to choose depends on the load of the code-0 and the weight of the bow anchor, if you have one. We have combined a table to make it easier to choose between our models.



For more guides on how to choose the right equipment, visit our website www.batsystem.com.

		PB105 PB105BL 26'-33'	PB105-1 PB105BL-1 26'-33'	PB120 PB120BL 32'-42'	PB120-1 PB120BL-1 32'-42'	BUT48PB 32'-42'	PB140 36'-47'	PB150 45'-55'	Race80 26'-32'	Race100 30'-42'	STR80 -40'	STR110 -47'
Anchor		15 kg ✓	X	20 kg ✓	X	X	30 kg ✓	30 / 50 kg ✓	X	X	X	25 kg ✓
Gennaker		Max 80m ²	Max 80m ²	Max 115m ²	Max 115m ²	Max 115m ²	Max 130m ²	Max 150m ²	Max 80m ²	Max 130m ²	110m ²	150m ²
Code-0 Working load		1500 kg	1500 kg	2500 kg	2500 kg	2500 kg	2500 kg	2500 kg	1500 kg	2500 kg	1500 kg	2500 kg
Ladder in casing		✓	✓	✓	✓	Fixed Ladder	✓	✓	✓	✓	✓	✓
Removable ladder		✓	✓	✓	✓	X	✓	✓	✓	✓	✓	✓
Pulpit		PPK600	PPK600	PPK600 PPK900	PPK600 PPK900	-	PPK800 PPK900	PPK800 PPK900	-	-	X	X
Accessories		H250 P1086	H250 P1086	H300H300 P1087	H300 P1087	-	P1306 P1087 P1308	P1307	-	-	X	X

Bowsprits - sailing yacht/powerboat

COMFORT



Bowsprits with welded ladder and sturdy grips for better stability. Available for both sailing- and powerboat.



Welded ladder
For better stability.



Fixed handles
For better grip.



Foldable ladder
Telescopic.



BUT26HP

BUT26MP

BUT48MP

BUT48PB

BUT26

BUT48

Art	L (mm)	B (mm)	H (mm)	Handle height	Steps	Products
BUT26HP*	650	330	928	100	3	BUT26, HP65 welded
BUT26MP*	550	360	928	100	3	BUT26, MP55 welded
BUT48MP*	700	480	1120	350	3	BUT48, MP75 welded
BUT48PB*	1180	532	1120	350	3	BUT48, PB120 welded
BUT26	218	293 cc	928	100	3	BUT26 for welding
BUT48	350	376 cc	1120	350	3	BUT48 for welding

*Also available in blackline



CLASSIC



A series of bowsprits for classic boats with the main focus on simplifying getting on and off the boat. Can be combined with a ladder and an anchor up to 15 kg. Compatible with Gennaker between 50 and 115 m².



Ladder
Ladder in casing or hook ladder as an option.



Anchor holder
Integrated on two models.

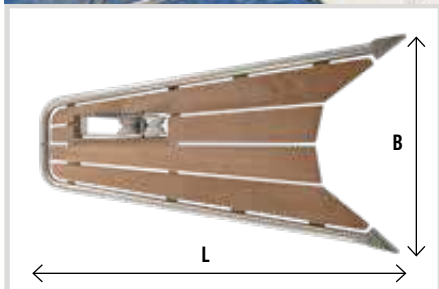

HP65

GPT100 / GPAT100

PT10044

Art	L (mm)	B (mm)	Tube (mm)	For boats	For gennaker	Step surface	Standard anchor roller	Rec Anchor	Fitting ladder	Fitting pulpit
HP65	650	330	32	18'-28'	50 m2	Teak	1402, accessory	10 kg	BKT72-250, BKT73-250, BU60P	-
GPT100	1160	530 +/-50	32	26'-33'	80 m2	Teak	-	-	BKT72, BKT73, BKT73T, BU75P, BU75P-4	PPK600, PPK900
GPAT100	1160	530 +/-50	32	26'-33'	80 m2	Teak	P1301	10 kg	BKT72, BKT73, BKT73T, BU75P, BU75P-4	PPK600, PPK900
PT10044	1170	530 +/-50	42	32'-42'	115 m2	Teak	P1301	15 kg	BKT72, BKT73, BKT73T, BU75P, BU75P-4	PPK600, PPK900

SHAPE



Gennaker bowsprits designed with a curved shape. The bowsprit meets the further part of the bow so as to have a wider tread and still a nice attachment.



Curved fittings

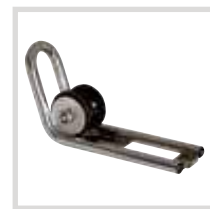

Anchor holder
Accessory.

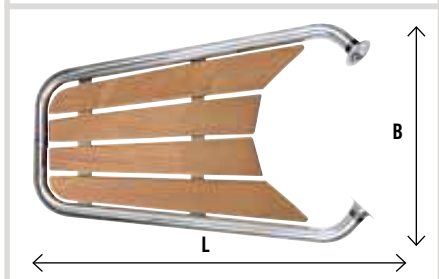

GPT70S

GPT95S

Art	L (mm)	B (mm)	Tube (mm)	For boats	For gennaker	Step surface	Anchor roller	Rec Anchor	Fitting ladder	Fitting pulpit
GPT70S	675	385	32	18'-30'	70 m2	Teak	1402, accessory	10 kg	BKT72, BKT73, BU75P, BU75P-4	-
GPT95S	950	415	32	26'-33'	80 m2	Teak	P1301, accessory	10 kg	BKT72, BKT73, BU75P, BU75P-4	PPK600, PPK500

FINGERTIP CONTROL IN ALL WEATHER



Jefa Steering
S Y S T E M S

For a complete range of products visit
www.batsystem.se

Jefa Rudder
S Y S T E M S

POWERIL

Windlass for all types of anchoring



POWERIL INSIDE
500W / 1000W



POWERIL CAPTAIN C
500W / 1000W



POWERIL CAPTAIN M
500W / 1000W



ACCESSORIES

For a complete range of products, visit www.batsystem.se

Bowsprits - accessories

PULPITS STANCHIONS HANDLES CODE-O KIT



PULPIT

Art	Width (mm)	Height (mm)	Tube (mm)	Description
PP350	350	500	25	
PP350-1	350	500	25	Small pupit for deck mounting
PPK500	480	500	25	
PPK600	600	600	25	
PP620	315	620	25	Pulpit for mounting in Stanchion socket
PPK800	800	610	25	
PPK900	800	625	25	
LP200	-	-	-	Lantern plate for PPK600, PPK800, PPK900

CODE-O KIT

Art	Length (mm)
P10044	800
P10044-1	1000

HANDLE

Art	Width (mm)	Height (mm)	Tube (mm)	Fitting dim (mm)
H250	250	65	25	32
H300	300	65	25	42

STANCHIONS

Art	Height (mm)	Description
2945S	610	Stanchion welded top
2943S	610	Stanchion plastic top
2941		Stanchion socket 90°
2942		Stanchion socket 84°

EVOLUTION FITTING

Art	Tube (mm)
P1086	32
P1087	42
P1088	50

ANCHORS ANCHOR ROLLERS



Båtsystems recommendation of anchors for bowsprits and anchor holders, specially tested for optimum performance.



ANCHOR

Art	Weight (kg)	Material	Art	Weight (kg)	Material
Delta 16G	16	galvanized	Classic 1907S	7,5	stainless
Delta 16S	16	stainless	Classic 1910	10	galvanized
Delta 20G	20	galvanized	Classic 1910S	10	stainless
Delta 20S	20	stainless	Classic 1915	15	galvanized
Delta 25G	25	galvanized	Classic 1915S	15	stainless
Delta 25S	25	stainless	Classic 1920	20	galvanized
			Classic 1920S	20	stainless

ANCHOR ROLLER

Art	Width (mm)	Height (mm)	Max load
P1301	200	185	15 kg
P1308	205	200	20 kg
P1307	235	235	30 kg
P1306	75	150	50 kg
1402	Anchor roller for HP65, MP55, GPT70S		10 kg
P1309	Anchor lock. L=105 mm, B (max) 90 mm.		



Stern platforms

Get closer to the water

Does the water seem too far away when you are at sea? Do you avoid water activities such as inshore swimming, waterskiing or fishing, because it seems too difficult to drag yourself up afterwards? A stern platform gets you closer to the water, and will get you safely back onboard again. Besides making stern mooring and anchoring easier, it also helps you access a towed dinghy, or just hanging out watching the sunset.

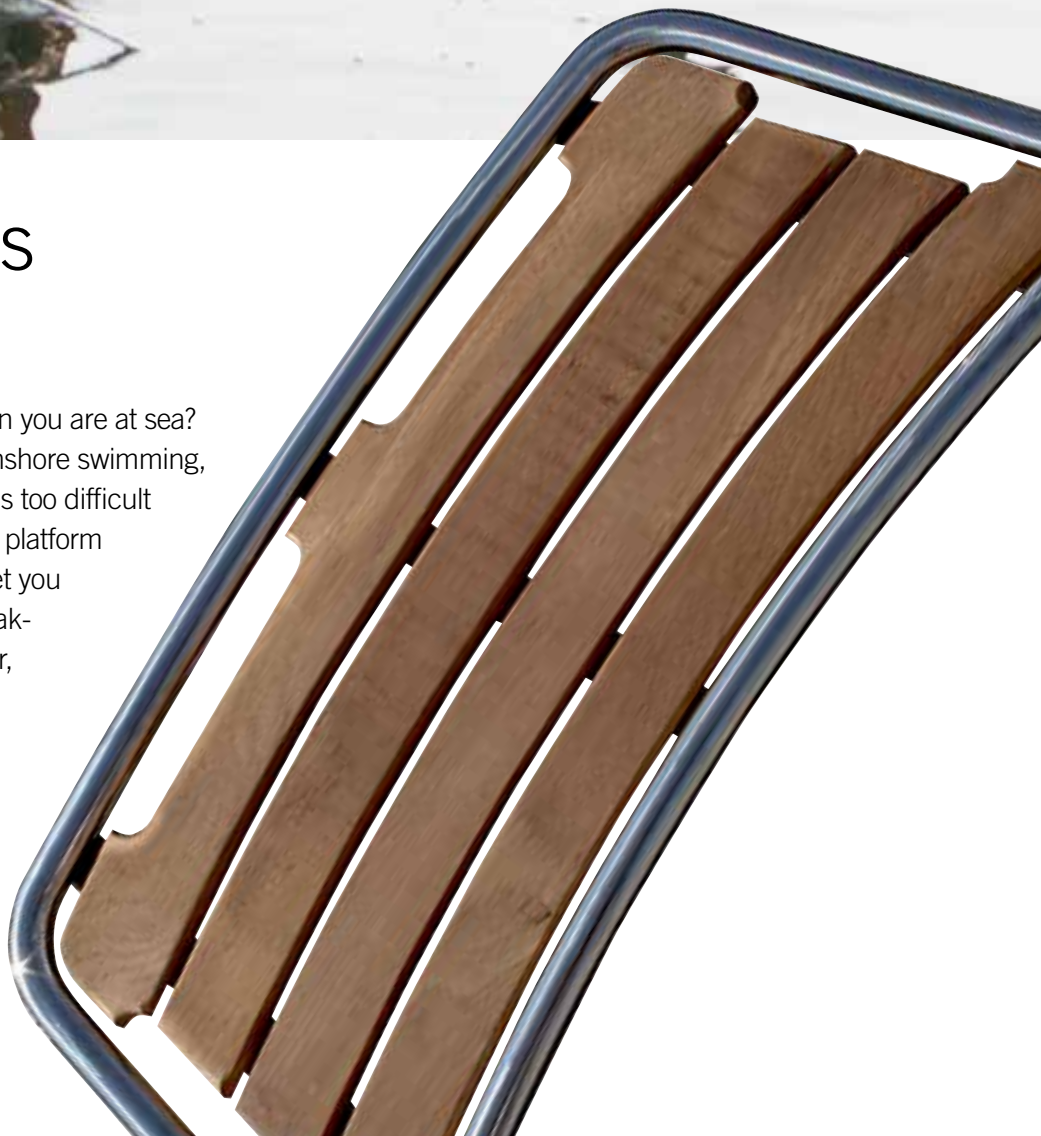



POWERBOAT

Platforms with flexible fastenings that fits most powerboats. Horizontal parallel boards in solid teak.



35 SERIES

Stern platforms for sailing yachts, with safety grips. Three horizontal parallel boards in solid teak.

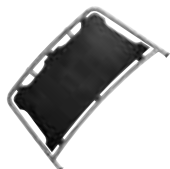

45 SERIES

Functional stern platforms for sailing yachts, with safety grips and adjustable telescopic stanchions. Four horizontal parallel boards in solid teak or Blackline surface.

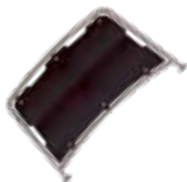

60 SERIES

Large stern platforms for sailing yachts, with safety grips. Five horizontal parallel boards in solid teak.



GIG

Two-pieced platforms for gigs with flexible fastenings. Horizontal parallel boards in solid teak.



Stern platforms

POWERBOAT



Platforms with flexible fastenings that fit most powerboats. Can be combined with a variety of ladders.

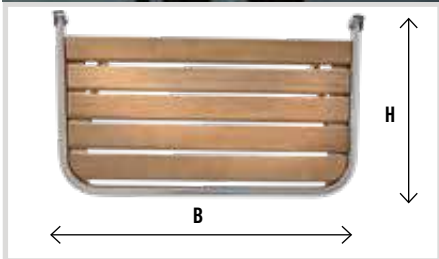

Ladder
Ladder in casing as an option.



Ladder
Bathing ladder as an option.



PM3642 PM4550 PM4580 PM19050 PM2606030 PM1803530 PMR20045



Art	B (mm)	H (mm)	Tube (mm)	Step surface	Recommended ladders
PM3642	450	360	25	Teak	BT70
PM4550	500	450	25	Teak	BT70, BT115, BT145
PM4580	800	450	25	Teak	BT70, BT115, BT145, BKT73, BKT73T, BKT74, BKT74T
PM19050	1900	500	25	Teak	BKT73, BKT73T, BKT74, BKT74T, BUT25, BUT45, BUT47
PM2606030	1750-2600	500	32	Teak	Adjustable width BKT73, BKT73T, BKT74, BKT74T, BUT25, BUT45, BUT47
PM1803530	1780	450	32	Teak	BKT73, BKT73T, BKT74, BKT74T, BUT25, BUT45
PMR20045	2000	700	32	Teak	BKT73, BKT73T, BKT74, BKT74T, BUT25, BUT45, BUT47

Stern platforms

35 SERIES



The platforms are equipped with a safety grip that is easy to grab and hold on to while bathing or in a "man overboard" situation.



Telescopic ladder
As an option.



Safety grip
For better grip.



Down struts
Telescopic

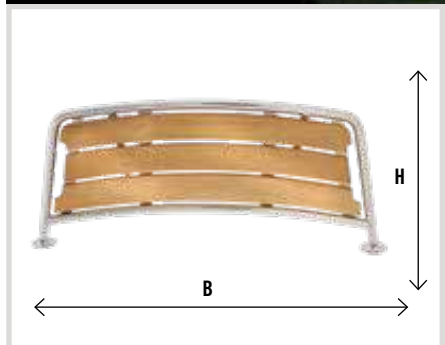

PT8035

PT10035

PT1253530

PT1553530

Art	B (mm)	H (mm)	Tube (mm)	Step surface	Recommended ladders
PT8035	840	380	25	Teak	BKT73, BKT73T, BKT74, BKT74T
PT10035	1000	380	25	Teak	BKT73, BKT73T, BKT74, BKT74T
PT1253530	1270	410	32	Teak	BKT73, BKT73T, BKT74, BKT74T
PT1553530	1550	410	32	Teak	BKT73, BKT73T, BKT74, BKT74T



Stern platforms

45 SERIES



Functional stern platforms for sailing yachts. The 45 series is equipped with safety grips which are easy to grab and hold on to while swimming or in a "man over board" situation. The telescopic struts can be adjusted horizontally and vertically, making it easy to mount the platform on many different types of boats and sterns.

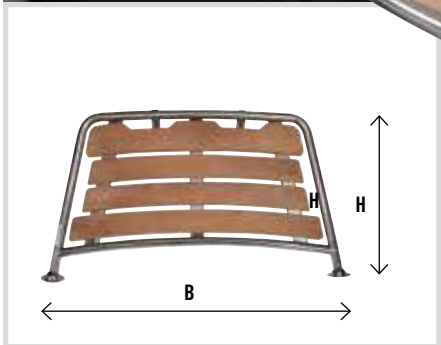

Telescopic ladder
As an option.



Safety grip
For better grip.



Adjustable struts
Horizontally and vertically.



Teak/Blackline
Blackline as an option.



45 Series - functional design with safety grips and adjustable telescopic struts.



PT8045BL / PT8045



PT1104530BL / PT1104530

Art	B (mm)	H (mm)	Tube(mm)	Step surface	Recommended ladders
PT8045	840	450	25	Teak	BKT73, BKT73T, BKT74, BKT74T
PT8045BL	840	450	25	Blackline	BKT73, BKT73T, BKT74, BKT74T
PT1104530	1040	450	32	Teak	BKT73, BKT73T, BKT74, BKT74T
PT1104530BL	1040	450	32	Blackline	BKT73, BKT73T, BKT74, BKT74T

60 SERIES



Functional stern platforms for larger yachts. Five parallel teak boards and supportive struts on the top. Two of the platforms are equipped with safety grips.



Telescopic ladder
As an option.



Struts upwards
For better stability.

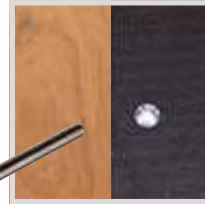

Teak/Blackline
Blackline as an option.



Safety grip
Available on PT1006030
and PT1256030

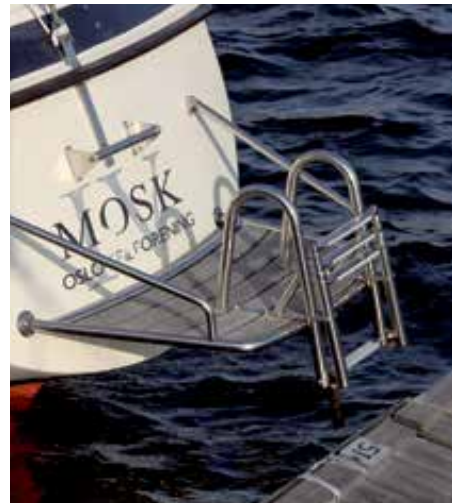
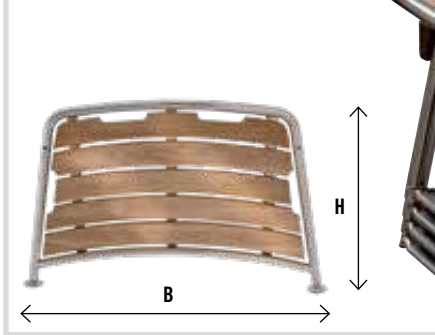

PR1306030 for sailboats with surface-mounted rudder.



PT1006030BL / PT1006030 PT1256030BL / PT1256030 PR1306030BL / PR1306030

Art	B (mm)	H (mm)	Tube (mm)	Step surface	Recommended ladders
PT1006030	1090	600	32	Teak	BKT73, BKT73T, BKT74, BKT74T
PT1006030BL	1090	600	32	Blackline	BKT73, BKT73T, BKT74, BKT74T
PT1256030	1310	600	32	Teak	BKT73, BKT73T, BKT74, BKT74T
PT1256030BL	1310	600	32	Blackline	BKT73, BKT73T, BKT74, BKT74T
PR1306030	1300	600	32	Teak	BT70, BKT73-250
PR1306030BL	1300	600	32	Blackline	BT70, BKT73-250

Bathing platforms

GIG



Two-piece platforms for gigs. The platform is secured by adjustable support-stanchions upwards and has flexible fastenings.



Struts upwards
For better stability.



Ladder
Combine with ladder.
Mount with swivel fittings.

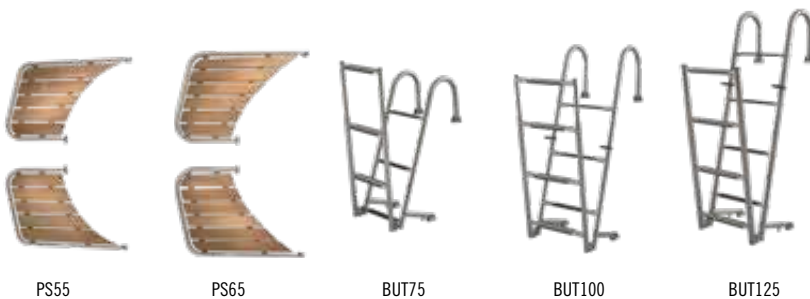
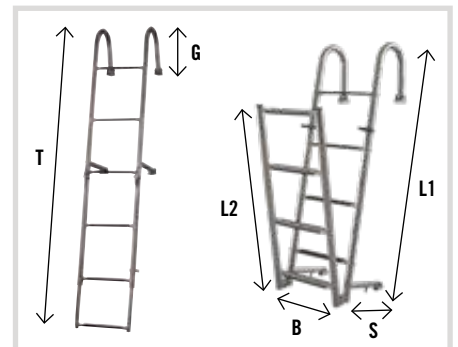
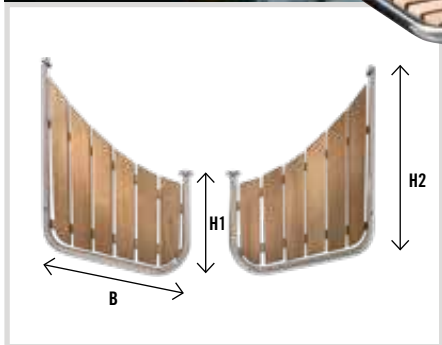

Art	B (mm)	H1 (mm)	H2 (mm)	Tube (mm)	Step surface	For boats
PS55	530	430	950	25	Teak	22'-28'
PS65	650	470	950	32	Teak	26'-34'

Art	T (mm)	L1 (mm)	L2 (mm)	B (mm)	G (mm)	S (mm)	Steps
BUT75	1530	750	780	280	200	150-300	6
BUT100	1884	1000	884	335	250	150-300	7
BUT125	2034	1200	834	335	270	150-300	8



Accessories for easy boarding

BOLLARDS

Art	Height (mm)	Diameter (mm)	Foot (mm)	Bolt	Description
BP50095	95	Ø50	91x91	M6	
BP60125	120	Ø60	97x120	M8	
BP70145	145	Ø70	120x140	M8	
BP80200	200	Ø76	125x200	M12	
BPL80200	200	Ø76	125x200	M12	6 LED, 12V, 6x0,15W

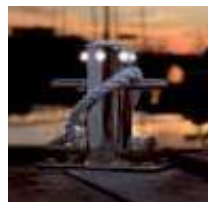

CLEATS

Art	H (mm)	B (mm)	Foot (mm)	Bolt	C/C mm	Description
P145	43	145	90x31	M8	50	Cleat
P200	54	200	120x35	M10	69	Cleat
P250	67	250	150x38	M10	82	Cleat
PB250	-	-	150x38	M10	82	Plate
P285	80	285	160x40	M12	100	Cleat
PB285	-	-	160x40	M12	100	Plate
P315	85	315	180x50	M16	120	Cleat
P360	90	360	180x50	M16	120	Cleat
PB360	-	-	180x50	M16	120	Plate

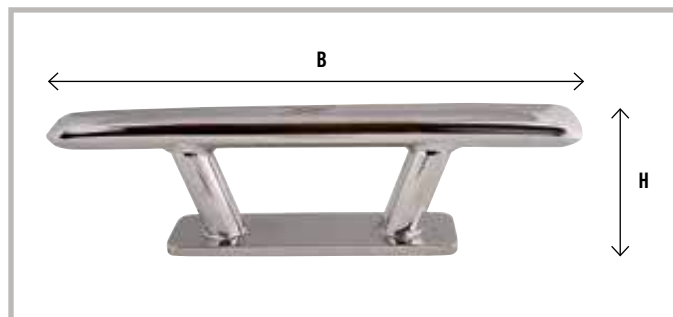

GRABRAILS

Art	L (mm c/c)	H (mm)	Tube (mm)	Foot	Bolt/Bolthole	Lighting
GR350	350	60	Ø25	A x2	M8	-
GR500	500	60	Ø25	A x2	M8	-
GR750	750	60	Ø25	A x2	M8	-
GR850	850	60	Ø25	A x3	M8	-
GR1500	1500	60	Ø25	A x3	M8	-
GRL500	500	60	Ø25	A x2	M8	3 LED, 12V
GRL750	750	60	Ø25	A x2	M8	4 LED, 12V
GRL850	850	60	Ø25	A x3	M8	4 LED, 12V
GRL1250	1250	60	Ø25	A x3	M8	6 LED, 12V
GRL1500	1500	60	Ø25	A x3	M8	6 LED, 12V
GRS350	350	60	Ø25	B x2	Ø5	-
GRS500	500	60	Ø25	B x2	Ø5	-
GRS750	750	60	Ø25	B x2	Ø5	-
GRS850	850	60	Ø25	B x3	Ø5	-
GRS1250	1250	60	Ø25	B x3	Ø5	-
GRS1500	1500	60	Ø25	B x3	Ø5	-
GRB200	200	60	Ø25	C x2	M8	-
GRB350	350	60	Ø25	C x2	M8	-
GRB500	500	60	Ø25	C x2	M8	-
GRB750	750	60	Ø25	C x2	M8	-

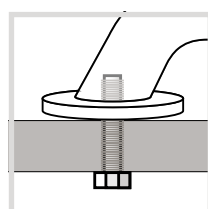
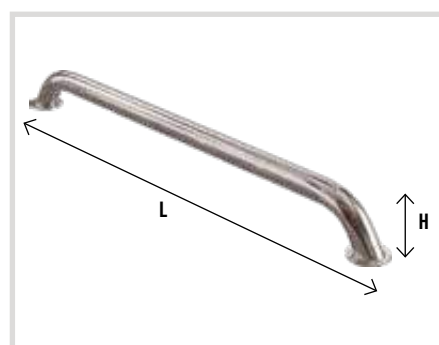

A Feet with through-bolts.

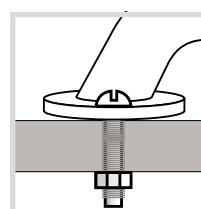

B Feet with screw holes for exposed bolt.

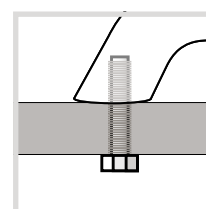

C Through-bolts.

Leather coating available in quantities

FOOTSTEPS

Art	Description
F2890	Footstep 90°, c/c 28 cm
F2820	Footstep 20°, c/c 28 cm
F2840	Footstep 40°, c/c 28 cm



HANDLES

Art	Width (mm)	Height (mm)	Tube (mm)	Fitting dim (mm)
H250	250	65	25	32
H300	300	65	25	42





Lifting devices

Dinghy in good company

Do not let your dinghy weigh you down, or hang loosely in long dangling ropes. With a flexible and reliable davit you keep the dinghy off the boat, and still tightly attached during sailing. The smart construction minimizes the total length of your sailing yacht and doesn't make it tail-heavy. Complement with a bathing platform, and embarking/disembarking will be a piece of cake.

Davits

DAVITS



Sturdy, flexible and reliable davit. Easy to mount and dismount and can be retrofitted with no need for reinforcements of your boat's transom. The davits are available with two different stern fittings, one for a straight stern and one for an angled or rounded stern. The smart design uses only pulling and pushing forces, allowing the davit to move both vertically and horizontally, which optimizes the centre of gravity and keeps the dinghy off the boat.

Manufactured in stainless AISI 316 steel, polished to a high gloss finish. Set of blocks and ropes are optionally available.

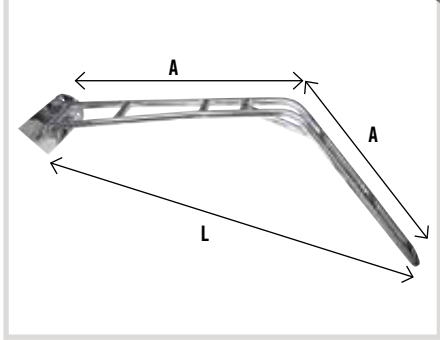

DV25

DV32

DV42

Art	L (mm)	A (mm)	Fitting (mm)	Max load/davit (kg)	Kit
DV25	1300	750	200x120	50	
DV25-1	1300	750	200x120, angled (5°, 10°, 15°)	50	
DV25 KIT	1300	750	200x120	50	2 x DV25, DV-block
DV25-1 KIT	1300	750	200x120, angled (5°, 10°, 15°)	50	2 x DV25-1, DV-block
DV32	1530	875	260x160	100	
DV32-1	1530	875	260x160, angled (5°, 10°, 15°)	100	
DV32 KIT	1530	875	260x160	100	2 x DV32, DV-block
DV32-1 KIT	1530	875	260x160, angled (5°, 10°, 15°)	100	2 x DV32-1, DV-block
DV42	1740	993	307x160	150	
DV42-1	1740	993	307x160, angled (5°, 10°, 15°)	150	
DV42 KIT	1740	993	307x160	150	2 x DV42, DV-block
DV42-1 KIT	1740	993	307x160, angled (5°, 10°, 15°)	150	2 x DV42-1, DV-block



Straight fitting
For straight stern.



Angled fitting
For rounded stern. 5, 10 or 15 degrees.

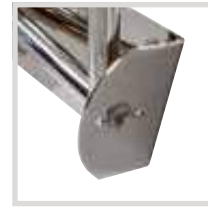

Disassembly
Through bolt for easy removal.



Set of blocks
Included in the kits.



Davits

ACCESSORIES



Art	Description
P1112	Straight fitting 90°
P1110	Angled fitting 5°, 10°, 15°
DV-block	Accessories for 1 davit arm. Cordage, Seldén mainsheet block (4-cut)
DV-42block	Accessories for 1 davit arm. Cordage, Seldén mainsheet block (6-cut)
RA552	Angled fitting for solar panel (Kit 2 fittings, 2 rails). Only for DV25



More mounting options in our gallery at www.batsystem.com

Crane

CRANE



A smart crane for mounting on deck and in the pulpit. The crane can lift 50 kg and is suitable to hoist up the outboard or for loading.



Block fitting
Fitting for block winch.

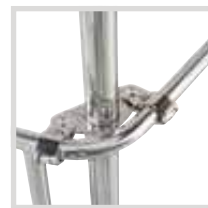

Pulpit fitting
For stability.

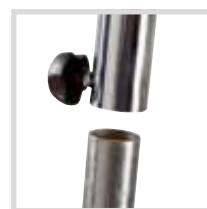

Rod coupling
Easy to mount on and off the crane.



P1001
Mounting option for transom.



Pulpit not included

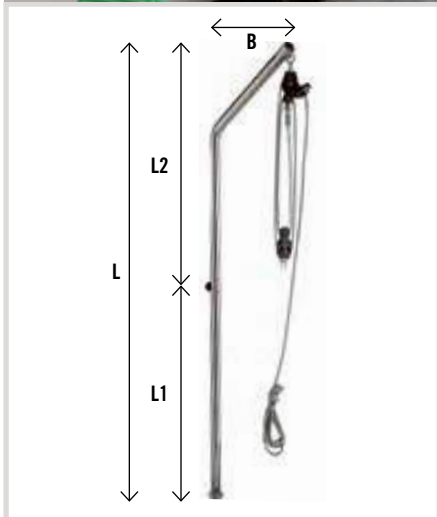

Art	Description	L (mm)	L1 (mm)	L2 (mm)	B (mm)	Max load	Tube
Crane 42	Crane with blocks	1750	950	800	550	50 kg	Ø42mm

Art	Description
P1001	Mounting option for transom. Ø42 mm fitting, FM10

GANGWAY

GW220



P1113



Art	Description
GW220	Gangway. L=2200 mm, W=350 mm, 11 kg.
GW260	Gangway. L=2600 mm, W=350 mm, 12,5 kg.
P1113	Gangway hook mounting, pivoted



Radar poles

RADAR POLE KIT

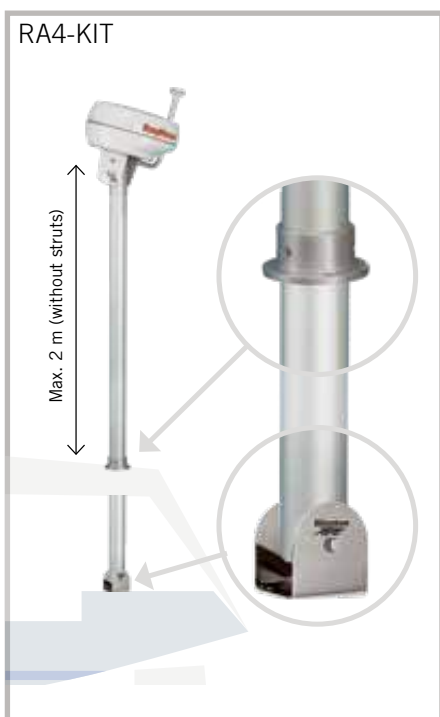

Art	Pole	Polefoot	Strut	Radar plate	Top fittings	Other fittings
RA1-KIT	80x2000 mm, aluminium	Deck	2 x 1500 mm (fitting for deck and pulpit, (Ø25 mm))	280x280 mm	Straight	-
RA2-KIT	80x2000 mm, aluminium	Tiltable 0-90°	2 x 1500 mm (fitting for deck and pulpit)	280x280 mm, tiltable	Tiltable	-
RA3-KIT	80x2000 mm, aluminium	Deck	2 x 1500 mm (fitting for deck and pulpit)	280x280 mm, tiltable	Tiltable	For solar panel*, crane max 50 kg
RA4-KIT	80x3000 mm, aluminium	Tiltable 0-90°	-	280x280 mm, tiltable	Tiltable	-
RA5-KIT	80x2500 mm, aluminium	Tiltable 0-90°	2 x 1500 mm (fitting for deck and pulpit)	-	For wind charger (38 mm)	-

*Excluding solar panel

CRANE POLE KIT



Art	Pole	Polefoot	Strut	Crane	Other fittings
RA6-KIT	80x2000 mm, aluminium	Deck	2 x 1500 mm (fitting for deck and pulpit, Ø25 mm)	RA702, max 50 kg	-
RA7-KIT	80x2000 mm, aluminium	Deck	2 x 1500 mm (fitting for deck and pulpit)	RA702, max 50 kg	Solar panel fitting (Excluding solar panel)

RADAR POLE SYSTEM



Art	Description
RA100	Radar pole diam 80 mm tube aluminium, per meter
RA120	Radar pole diam 80 mm 2000 mm tube aluminium
RA125	Radar pole diam 80 mm 2500 mm tube aluminium
RA130	Radar pole diam 80 mm 3000 mm tube aluminium
RA101	Joint tube for 80 mm radar pole
RA201	Deck mounting with standard o-ring
RA203	Fitting for stern mounting 0-90°
RA301	Top fitting with screw standard
RA302	Top plate for radar 280x280 mm
RA303	Top fitting tiltable for top plate
RA304	Antenna fitting with 1" NF screw thread

Art	Description
RA402	90° pulpit fitting
RA415	A complete strut with fittings for deck and pulpit (Ø25 mm), L=1500 mm
RA538	Fitting for wind charger, Ø38 mm
RA548	Fitting for wind charger, Ø48 mm
RA550	Solar panel fitting, 80 mm, rotatable 360°, tilting 90°
RA610	Angle adjustment for deck fittings 0 - 10°
RA701	Crane 600 mm, max 50 kg
RA702	Crane 1000 mm, max 50 kg
RA705	Fitting for RA701 and RA702
9556	Working Light. 8 LED, 9-36V, 11W, IP67



Windlass systems

Smoother Scandinavian mooring

Forget roly nights at anchor. Keep the bow into the swell by stern-anchoring and savour quiet comfortable nights on the hook. Or berth “bow-to” and enjoy the tranquillity and privacy facing away from the busy marina quay.

Imagine sliding into the harbour, easily manoeuvring your boat while you have full control over your stern-anchor. A windlass system makes it easy to launch the stern-anchor, even under the hardest circumstances. When leaving the harbour, you just push the button, let the windlass drag your boat out to the anchor and hoist it up easily.

Windlass systems



FOR A COMPLETE WINDLASS SYSTEM:

- 1 Windlass
- 2 Cable kit
- 3 Fuse
- 4 Anchor holder
- 5 Leaded rope
- 6 Anchor
- 7 Swivel
- 8 Remote control



Windlass systems

WINDLASS

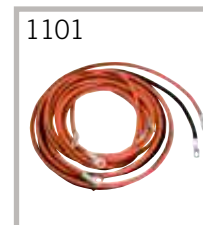
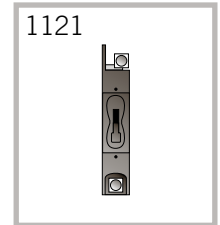

You will find anchors on page 29

Art.	Description
1016-14E	Windlass for internal starboard mounting. 12V, 1000W. 14 mm. Includes control panel, relay box and mounting kit.
2016-14E	Windlass for internal port mounting. 12V, 1000W. 14 mm. Includes control panel, relay box and mounting kit.
1100	Remote, complete. Wireless inc 1 key with 2 channels.
1105	Extra key.
1121	100A Fuse: Not included in 1016-14E/2016-14E.
1418	Aluminium plate 225 x 225 mm. For stern mount SB/P.
1151	Console
1450	Leaded rope 14mm x 50 m.
1475	Leaded rope 14mm x 75 m.
P1304	Anchor swivel.
1412	Through hull fitting with roller for anchor line.
1101	Cable kit 25 square mm (red 8 m, black 6 m, 8 cable lugs).
1127	Drive wheel, 16 mm leaded rope.
1128	Drive wheel, 14 mm leaded rope.

ANCHOR HOLDERS & ANCHOR DAVITS



You will find anchors on page 29

Art.	Length (mm)	Width (mm)	Fitting (mm)	Max load (kg)	Function
1300	450	80	280x80	15	
1325	680	80	530x80	15	
1326	400	145	80x335	15	Folded
1402	200	80	99x80 c/c	10	Fits HP65, MP55, GPT70S
1400K	410	80	170x80 c/c	15	
1400	510	80	125x80 c/c	15	
1405	525	-	120x150, tiltable	15	
1410	726	-	120x200, tiltable	20	
1410-1	726	-	120x200, tiltable	20	Tilted fitting
1420	726	-	120x200, tiltable	20	Strut, anchor locking
1420-1	726	-	120x200, tiltable	20	Strut, anchor locking, tilted fitting
P1116	-	-	-	-	Anchor tilt (1400, 1400K, 1405, 1410, 1410-1, 1420, 1420-1)
P1110	-	-	120 x 200	-	Tilted fitting (5°, 10°, 15°)
P1303	130	85	-	-	Anchor roller
P1112	-	-	120 x 200	-	Straight fitting

Fittings and spare parts – boarding

FITTINGS AND SPARE PARTS

More fittings and spare parts can be found on our website.

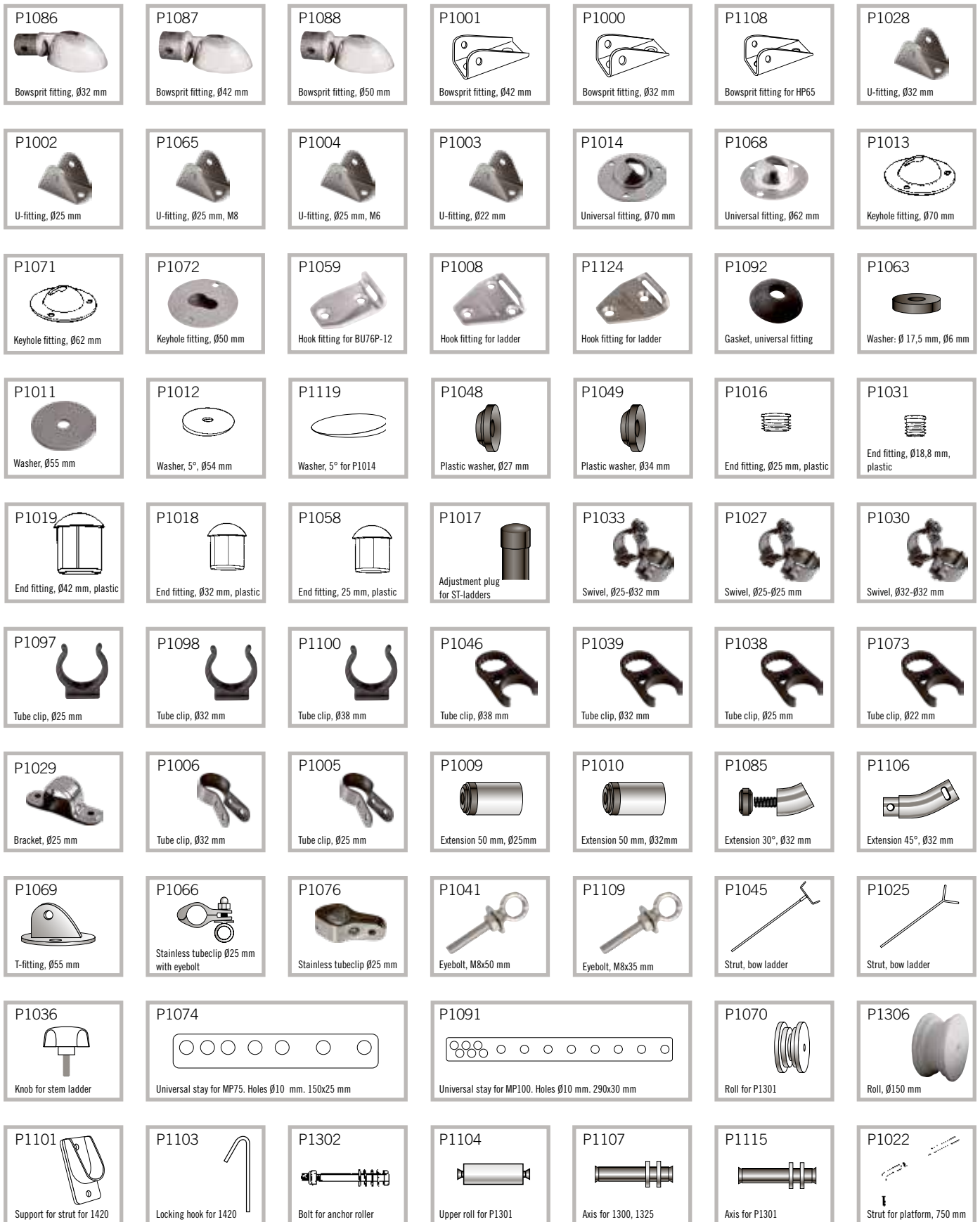

Gallery



Unsure about what fits your boat?
Visit the gallery at www.batsystem.com for inspiration and mounting options.

BOAT WORLD



NEW interceptors

Better comfort, safety and performance

Reduced fuel consumption

Interceptors respond 5-10 times faster than trim tabs

Built-in GPS, 3D-Gyro and 3D-Accelerometer

Active Roll and Pitch Control



Zipwake is a Dynamic Trim Control System like no other. Now at the push of a button, you can get immediate lift and stability for a safe, comfortable ride and you don't have to pay a fortune. Designed for powerboats 20 – 60 feet. Developed and manufactured in Sweden. Distributed in Sweden by Båtsystem.

Visit www.batsystem.se for a complete range of Zipwake products.

REVOLUTION

START KIT

Available in
KB300-S, KB450-S, KB600-S & KB750-S,
KB300-S CHINE & KB450-S CHINE



NEW

Gimbal Bracket, Intermediate & Chine interceptor

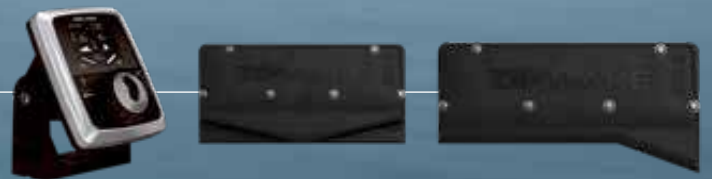

INTERCEPTORS

Available in
Straight, V-shaped, Intermediate & Chine



Zipwake is a fully automatic trim control system that gives you full control of your boat – both in terms of driveability and reduced fuel consumption. The advanced control system effectively reduces wave drag, which provides faster planning, smoother operation and thus considerably greater driving comfort. Experience the difference with a dynamic trim control!

ZIPWAKE

CHOOSE COMFORT. ENJOY PERFORMANCE.

Lighting

The pleasant light onboard

Just think of what lighting could do to enhance your boating experience. At Båtsystem, we know all about lighting and how to create a pleasant light, ambience and the feeling of more space. All this by using lights in the right way.

Want to learn more? Go to our website where you can watch inspirational videos and read articles about how to use light to improve the looks and values of your boat.





The Pleasant Light Onboard

The Pleasant Light Onboard

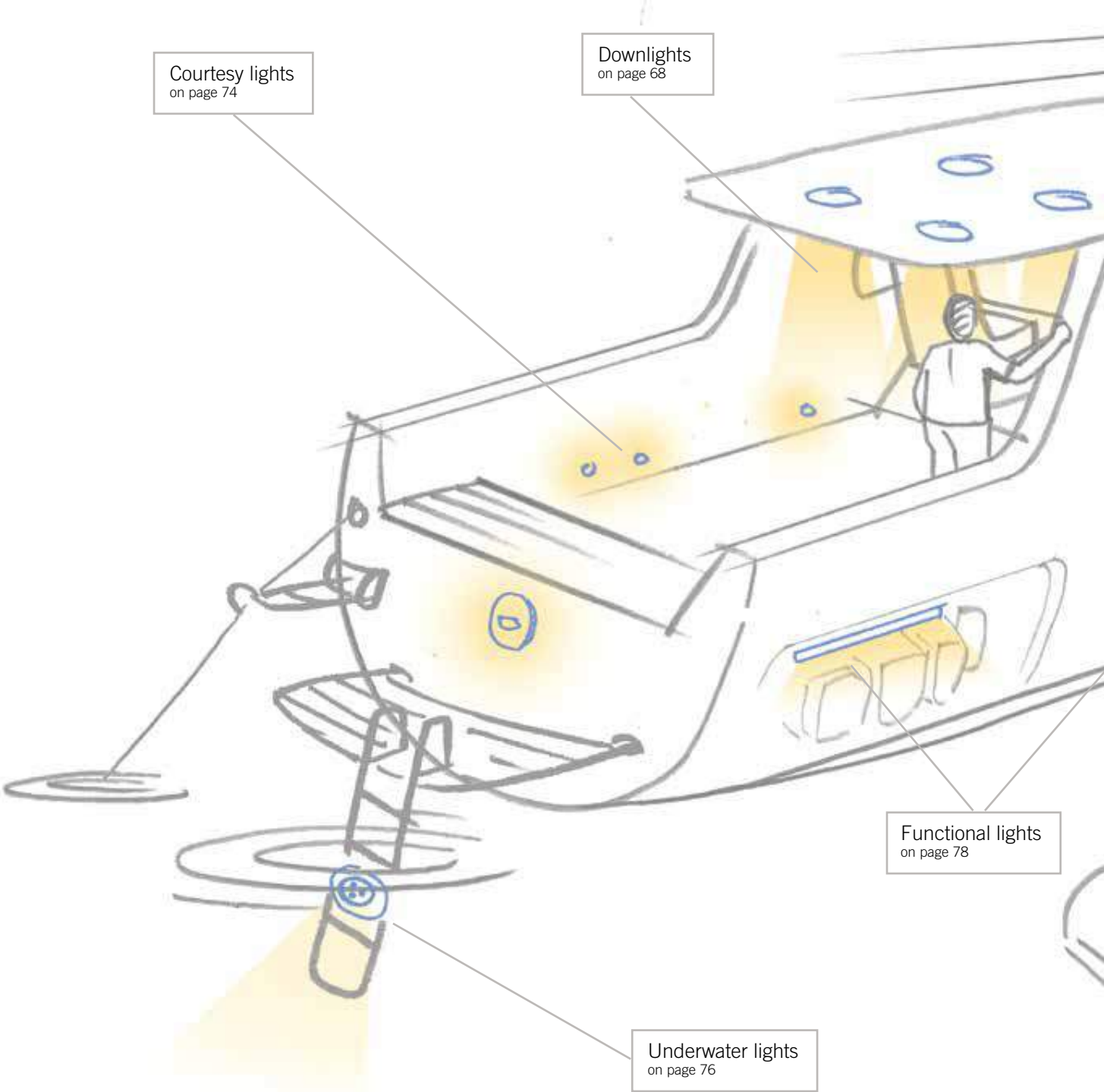

Functional lights
on page 78

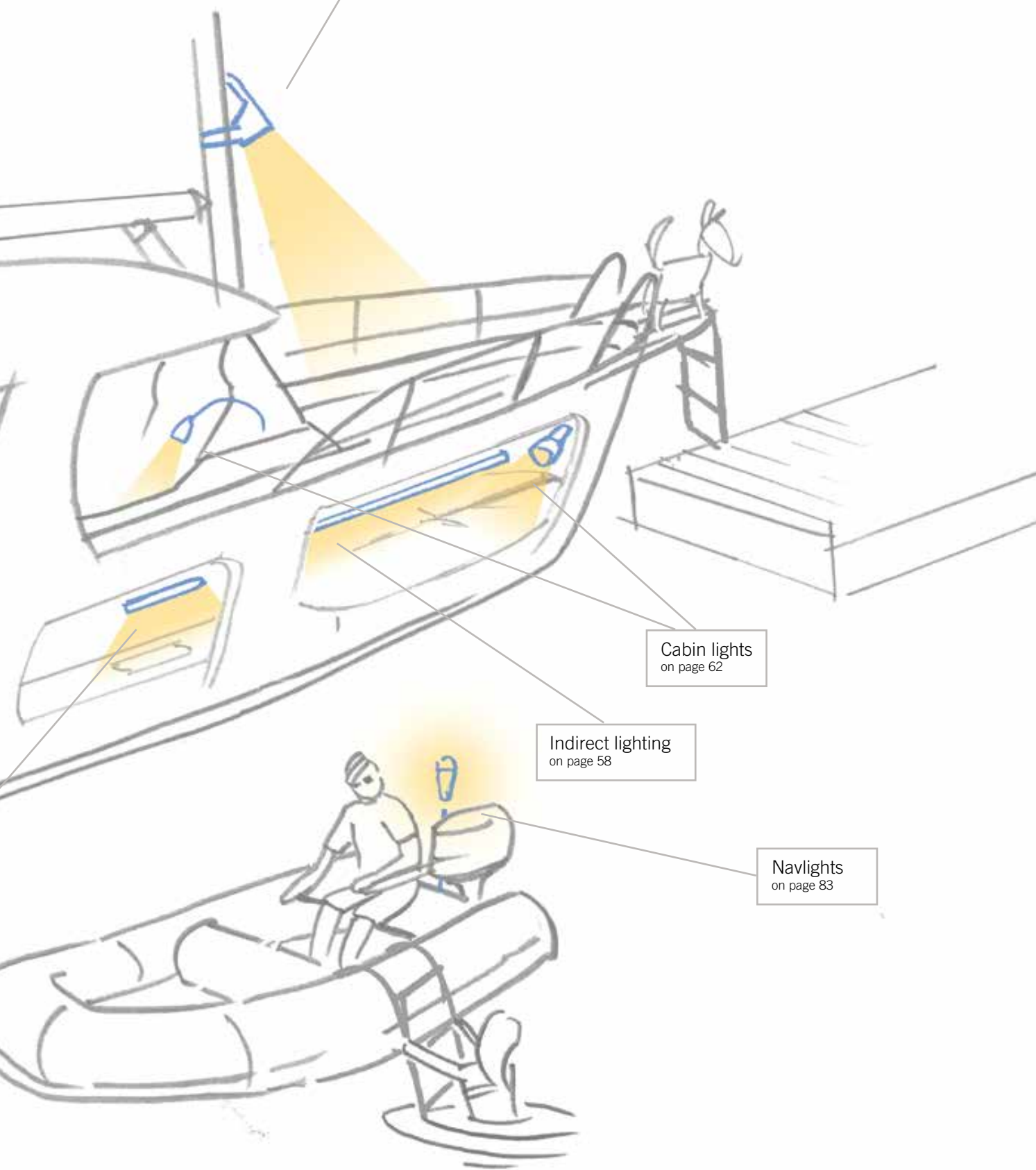

Cabin lights
on page 62

Indirect lighting
on page 58

Navlights
on page 83

Lighting design



CREATE SPACE WITH LED

To create a feeling of space and volume, illuminate the edges of your cabin with LED tape, profiles or mini-sleeve – small energy efficient diodes in adjustable lengths. The individual light sources shouldn't be seen, but the surrounding environment they are supposed to illuminate. Hide the light sources behind edges in the boat, or mount extra profiles with slits for LED tape, when needed. Get inspired by aircraft cabin design, where homogeneous light illuminates the edges, to avoid light dots and accomplish a smooth distributed light. That kind of luminous environment is what we try to obtain when designing interior boat lights.

While illuminating the sides of the cabin, take extra notice to dark corners and hidden areas, such as inside or under cupboards. By avoiding dark holes you enhance the feeling of space radically. Don't forget to define the ceiling and flooring, e.g. with a light over the main bulkhead and strings along the floor. Dimmed floored lights also make a perfect night light, while at anchor or in marinas.

Products: LED tape, Mini-sleeve, profiles

CREATE ATMOSPHERE WITH LED

With LED, you don't have to worry about power consumption. Many light sources can be used at the same time, without wasting too much energy. On the contrary, it's hard to find a more cost efficient way to make your boat interior nice and comfortable. With plenty of small light sources and dimmers you can achieve a unique light that can be varied, according to atmosphere, hour and what you're up to. Look at the interior as a theatrical stage, where you can set the mood by using dimmers. Use several dimmers to adjust the light intensity, depending on what feeling you want to create or if you need to adjust the light intensity.

Products: LED tape, Mini-sleeve, room lighting, dimmers

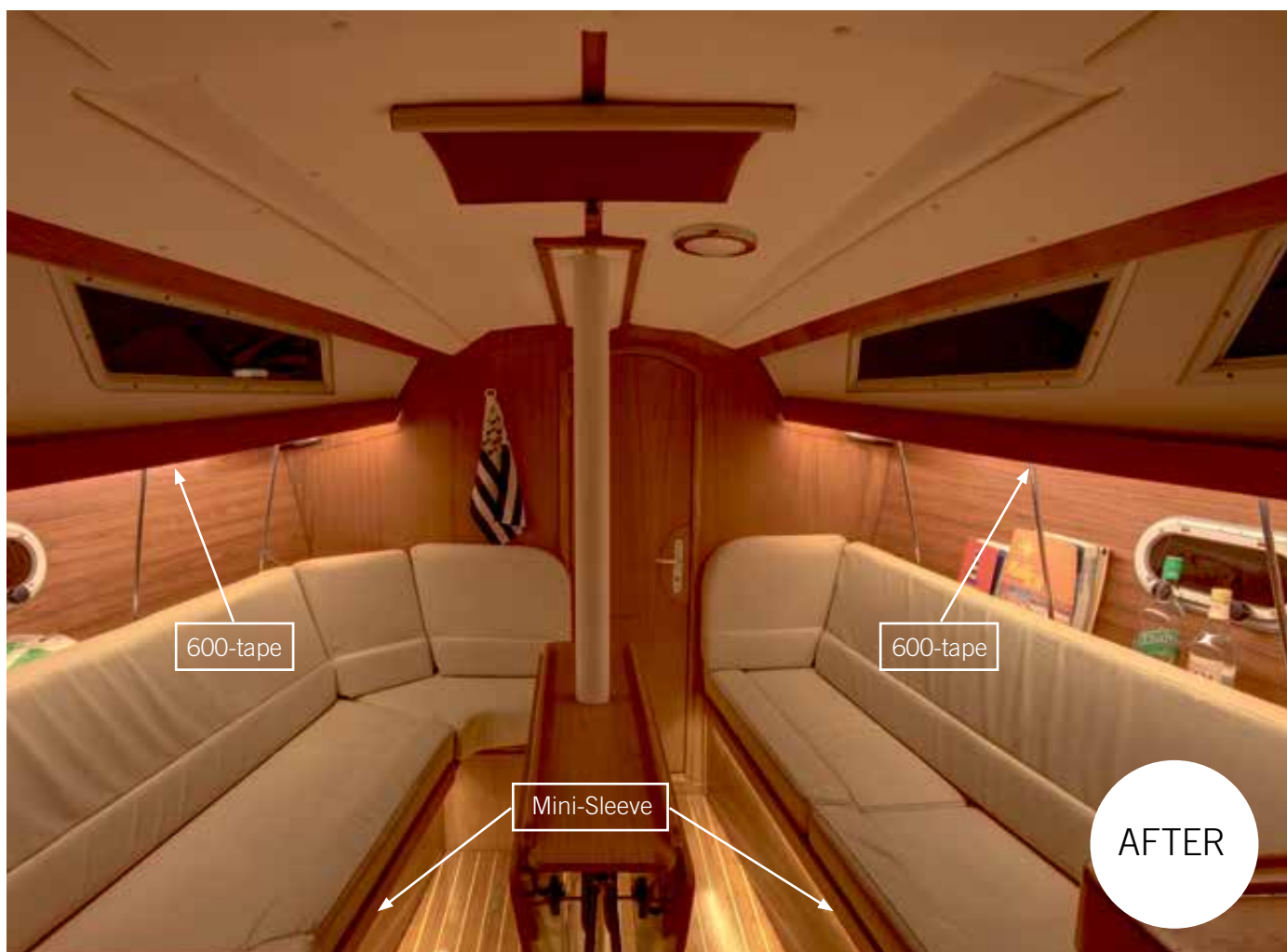

EFFECTS – COURTESY LIGHTS

The eye is drawn to light spots. Choose carefully what you want to highlight and use spotlights, to illuminate for instance the worktop in the galley or a painting on the bulkhead. Place one or two spot beam power-LED's as down light from the ceiling. As the spots shine onto the wooden salon table, it will reflect its warm tones back onto the ceiling. To allow true wooden colours to be reflected, an LED with a high Colour Reflection Index (CRI) is needed. These spot beams also give a great working light on the table. And dimmed down, they give a pleasant light for dining.

On the outside you can create flashy special effects, e.g. with dots on deck areas or underwater lights. These solutions will give your boat a personal appearance, and spread a fascinating glow when it's dark.

Products: spotlights, dimmers, dots, underwater lights

WORKING LIGHTS

Different types of lighting that can be adjusted by dimmers, give you a functional and activity-oriented luminous environment. Whether you read your nautical chart, cook dinner or relax with a book in the comfortable salon, you can adjust light intensity and atmosphere. Reading lights and high-end salon lights both work as functional lighting and might also improve the interior design. Use functional LED lighting in places that require to be lit up to a maximum, such as the engine room, cupboards, anchor lift compartments or deck lights. For night sailing, LED lighting that are inter-switchable between red and white are useful, placed at strategic places.

Products: reading lights, night lights, dimmers



Indirect lighting

Create space, design and atmosphere with indirect lighting. LED-technology has not only revolutionized power consumption. It also gives amazing possibilities in designing atmosphere onboard. Create space, enhance design and mood onboard with lighting. Many small sources of light create a unique light that can be varied depending on the effect you want to achieve.

Illuminate the edges of your cabin to create space and volume. The light sources shouldn't be seen, but the environment they illuminate. Compare with at the light design of airplanes and high-speed trains: homogeneous light illuminates the edges evenly around the cabin, avoiding any "light spots".



Indirect lighting



Mini Sleeve Frontlight



Mini Sleeve Sidelight

MINI SLEEVE

Mini Sleeve is a thin, flexible LED-tape, that can be used to create space and atmosphere onboard.

MAHOGANY PROFIL

-smart mounting for the Mini Sleeve

Mahogany profiles, which make mounting of the Mini Sleeve and LED tape easy, in order to achieve a smooth and discreet result. The profiles are mounted with the slit in desired direction.

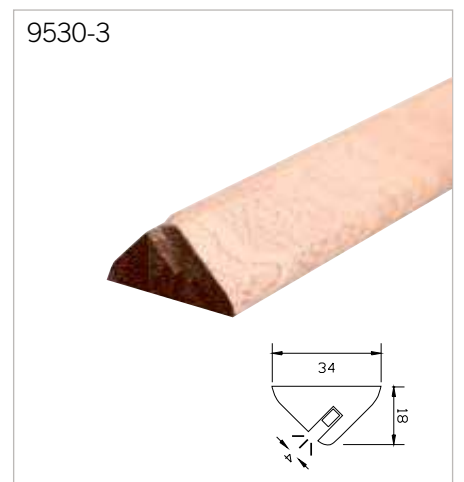
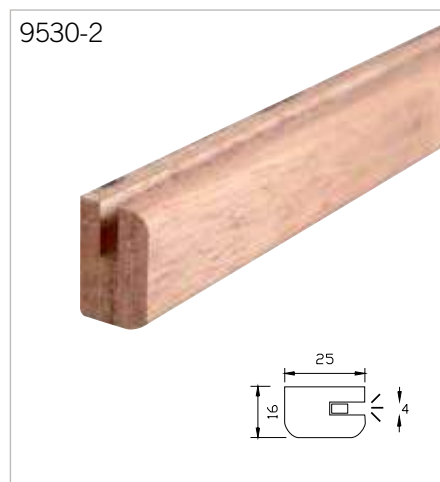
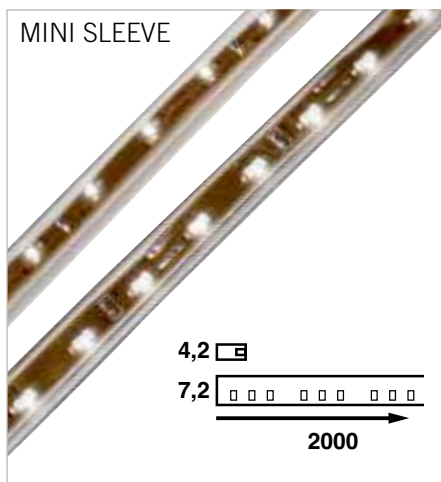

Art.	Product	Light	Light source	Volt (V)	Power (W)	Lumen	Length (m)	IP
9530Fv	Mini Sleeve Frontlight	White light	LED	12	4,8/m	160/m	2	65
9530Fb	Mini Sleeve Frontlight	Blue light	LED	12	4,8/m	160/m	2	65
9530Fv-5	Mini Sleeve Frontlight	White light	LED	12	4,8/m	160/m	5	65
9530Sv	Mini Sleeve Sidelight	White light	LED	12	4,8/m	160/m	2	65
9530Sb	Mini Sleeve Sidelight	Blue light	LED	12	4,8/m	160/m	2	65
9530Sv-5	Mini Sleeve Sidelight	White light	LED	12	4,8/m	160/m	5	65

Art	Product	Length (m)
9530-2	Mahogany profile for Mini Sleeve 9530s	1
9530-3	Mahogany profile for Mini Sleeve 9530s	1

Indirect lighting



LED TAPE

LED tape is a smart and effective technique to create space and atmosphere onboard.

Many sources of light create a unique light that can be varied depending on the effect you want to achieve. Illuminate the edges of your cabin to create space and volume.

Our popular high CRI LED-tape is available in four temperatures 2400 K, 2700 K, 3100 K and 4000 K.



LED TAPE 300

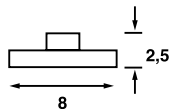

LED TAPE 600

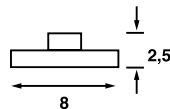

FLAT STRIPLIGHT

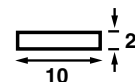

FLAT SUPERSTRIP

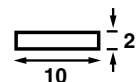

Art.	Product	Function	Light source	Volt (V)	Power (W)	Lumen	CRI	Colour temperature (K)
9236-5	LED Tape 300	Tape 5m	LED / White light	12	5 /m	350/m	94	3100 (also available in 2400, 2700, 4000)
9236rgbw	RGBW-Tape	Tape 5m	LED/Red/green/blue/white	12	19,2/m			3200-3500K
9237-5	LED Tape 600	Tape 5m	LED / White light	12	9,6 /m	540/m	94	3100 (also available in 2400, 2700, 4000)
9230v	Flat Striplight	Tape 300mm	LED / White light	12	0,9			
9230r	Flat Striplight	Tape 300mm	LED / Red light	12	0,9			
9230b	Flat Striplight	Tape 300mm	LED / Blue light	12	0,9			
9290v	Flat Striplight	Tape 900mm	LED / White light	12	2,7			
9290r	Flat Striplight	Tape 900mm	LED / Red light	12	2,7			
9290b	Flat Striplight	Tape 900mm	LED / Blue light	12	2,7			
9430	Flat Superstrip	Tape 300mm	LED / White light	12	2,4	240	>70	
9430-24	Flat Superstrip	Tape 300mm	LED / White light	24	2,4	240	>70	
9231	Connector	For Flat Striplight						
9232	Cable	For Flat Striplight						
9236	Connector	For LEDtape						



LED PROFILE

Smart mounting of the LED tape that provides a more even light and protects the tape. Available in plastic or mahogany, both with milky lenses.



LED PROFILE



MAHOGNY PROFILE

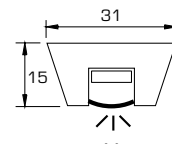

Art.	Product	Function
9250	LED Profile	Mounting rail 1m (Standard length). For LED tape, Flat Striplight and Superstrip
9530-5	Mahogany profile	Mounting rail 1m (Standard length). For LED tape, Flat Striplight and Superstrip



Cabin lights

Reading lights can preferably be used as spot lighting or to complement indirect and general illumination. LED lamps provide throughout a high quality light at very low power consumption. Many well-known boat builders make Båtsystems range of lighting their first choice for the excellence in design and lighting performance. Some lights now also have a built-in USB charger for smartphones.



Cabin lights



Art. / Product	Function	Light source	Volt (V)	Power (W)	Lumen	CRI	IP	Colour
LEIA LR1	Dimmer	LED	12V	3W	0-270lm	80	21	Chrome
LEIA LR1 USB	Dimmer, USB charger 2A	LED	12V	3W	0-270lm	80	21	Chrome
LEIA LR2	Dimmer	LED	12V	3W	0-270lm	80	21	Chrome
LEIA LR2 USB	Dimmer, USB charger 2A	LED	12V	3W	0-270lm	80	21	Chrome
LEIA LR3	Dimmer	LED	12V	3W	0-270lm	80	21	Chrome
LEIA LR3 USB	Dimmer, USB charger 2A	LED	12V	3W	0-270lm	80	21	Chrome
LEIA LR1	Dimmer	LED	12V	3W	0-270lm	80	21	Chrome
LEIA LR1 USB	Dimmer, USB charger 2A	LED	12V	3W	0-270lm	80	21	Chrome
LEIA LR2	Dimmer	LED	12V	3W	0-270lm	80	21	Chrome
LEIA LR2 USB	Dimmer, USB charger 2A	LED	12V	3W	0-270lm	80	21	Chrome
LEIA LR3	Dimmer	LED	12V	3W	0-270lm	80	21	Chrome
LEIA LR3 USB	Dimmer, USB charger 2A	LED	12V	3W	0-270lm	80	21	Chrome
LEIA LX1	Dimmer	LED	12V	3W	0-270lm	80	21	Chrome
LEIA LX1 USB	Dimmer, USB charger 2A	LED	12V	3W	0-270lm	80	21	Chrome

Cabin lights



Art.	Product	Function	Light source	Volt (V)	Power (W)	Lumen	CRI	IP	Colour
2093-D1USB	Tube D1	Switch, USB charger 1A	LED	12	0,6	60	>80	21	Aluminium
2093-D2USB	Tube D2	Switch, USB charger 1A	LED	12	1,2	60x2	>80	21	Aluminium
2093-D1XUSB	Tube D1X	Switch, USB charger 1A	LED	12	0,6	60	>80	21	Aluminium
2093-D1	Tube D1	Switch	LED	12	0,6	60	>80	21	Aluminium
2093-D2	Tube D2	Switch	LED	12	1,2	60x2	>80	21	Aluminium
2093-D3	Tube D3	Switch	LED	12	0,6	60	>80	21	Aluminium
2093-D1X	Tube D1X	Switch	LED	12	0,6	60	>80	21	Aluminium
2093-D3X	Tube D3X	Switch	LED	12	0,6	60	>80	21	Aluminium
9445	Eris	Switch	LED	12-14	0,6	50	>80	21	Chrome, Matt silver, Black
94447-130	Kurs	Switch red/white light	LED	12	1,3	70	>80	21	Black, Matt silver
94447-330	Kurs	Switch red/white light	LED	12	1,3	70	>80	21	Black, Matt silver
8235	Chart	Switch red lens	Halogen	12	10	100		21	Chrome

Cabin lights

OPAL



CLASSIC



BAYSPOT

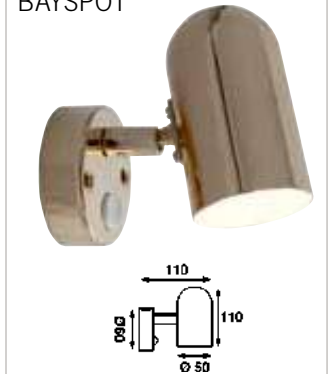

OPAL



MINI



OPAL II

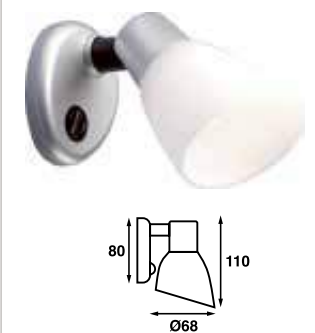

TUBE



TUBE MR11



Art.	Product	Function	Light source	Volt (V)	Power (W)	Lumen	CRI	IP	Colour
9460	Opal	Switch/White glass	LED	8-30	1,2	80	>80	21	Chrome, Brass
8960	Opal	Switch/White glass	Halogen	12	10	100		21	Chrome, Brass
9400	Classic	Switch	LED	8-30	1,7	140	>80	21	Chrome, Brass
8400	Classic	Switch	Halogen	12	10	100		21	Chrome, Brass
94205	Bayspot	Switch	LED	8-30	1,7	140	>80	21	Chrome, Brass
8205	Bayspot	Switch	Halogen	12	10	100		21	Chrome, Brass
9458	Mini	Switch	LED	8-30	2,3	200	>80	21	Chrome, White
94000	Opal II	Switch	LED	8-30	1,2	80	>80	21	Chrome, Matt silver
8000	Opal II	Switch	Halogen	12	10	100		21	Chrome, Matt silver
9405	Tube	Switch	LED	8-30	2	150	>90	21	Chrome, Matt silver, White
9406	Tube MR11	Switch	LED (MR11)	8-30	1,2	120	>80	21	Chrome, Matt silver, Silversand, White

Smart downlighting



CONTROL YOUR LIGHTS FROM YOUR SMARTPHONE!

Båtsystem's new addition to the popular Nova-family is a spotlight controlled from your smartphone. You can easily set the desired mood onboard by simply adjusting the color temperature and intensity in the app – ranging from bright, cool white to a cozier warmer, golden light.

The new Nova has a memory function. It retains preset settings and reboots accordingly. Choose temperature and brightness and get back to it instantly as soon as you switch the light on again.



DEVICE WITH APP

UNIT

UNIT

UNIT

UNIT

UNIT

UNIT

UNIT

UNIT

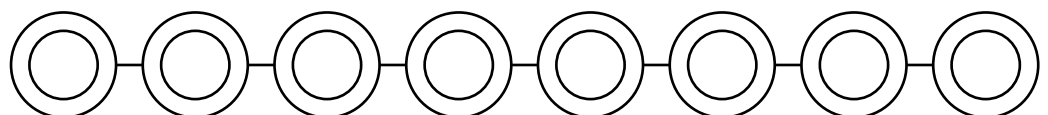

Up to 8 connected units depending on mobile device



BUILT IN TOUCH DIMMING

The light comes through a simple touch on the glass. Put your finger again to dim the light to the desired level. The IP-classed models provide possibilities to create mood light in environments exposed to water and moisture. Nova, Pinto and Vega are available with Master/Slave function. Dim up to 5 Slaves with one Master.



TOUCH



TOUCH MASTER

SLAVE

SLAVE

SLAVE

SLAVE

SLAVE

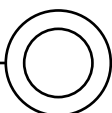
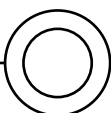
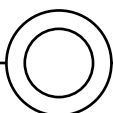
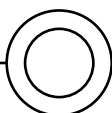
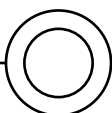
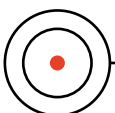



Downlights

Spread the warmth

Use one or two spot beam Power-LEDs as downlight from the ceiling to shine onto the dinner table. A wooden table will reflect its warm tones back onto the ceiling. To allow true wooden colours to be reflected, a LED with a high Colour Reflection Index (CRI) is preferred. These spot beams also give a great working light on the table, and dimmed down, they are the ultimate lighting for dining.



Downlights



NOVA

The Nova ceiling light has been installed over 700,000 times and is by far our most popular light. Driven by inspiration, it is continuously updated and is now available in a blend of diversity.

Modular components

The Nova can be combined in a variety of ways: choose between frames, colours, light sources, mounting type, switch or touch function, IP class and voltage. A Nova for everyone.

HOW TO CHOOSE NOVA:



FRAME



COLOUR



LIGHT SOURCE

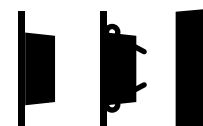

MOUNTING

SWITCH / TOUCH / NO SWITCH

IP54 (standard) / IP66 / IP21 (PowerLED)

12V / 24V

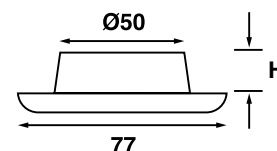

Nova SMD RV chrome



Nova VV light source



Nova BLE light source



Nova Touch chrome



Nova Power LED chrome

Art.	Product	Function	Glass	Light source	Volt (V)	Power (W)	Lumen	CRI	IP	Colour	H
9475	Nova		Transparent	LED	8-30	2	150	>90	54	Chrome, gold, matt silver, white	10
9475s	Nova	Switch	Transparent	LED	8-30	2	150	>90	54	Chrome, gold, matt silver, white	10
9475rv	Nova	Red/White light	Transparent	LED	8-30	2	150	>80	54	Chrome, gold, matt silver, white	10
9485v	Nova	White/warm white	Milky	LED	8-30	2	40/150	>80/90	54	Chrome, gold, matt silver, white	10
9485vvs	Nova	White/warm white, switch	Milky	LED	8-30	2	40/150	>80/90	54	Chrome, gold, matt silver, white	10
9485BT	Nova BLE	White/warm white	Milky	LED	12	2	200	>90	54	Chrome, gold, matt silver, white	10
9485	Nova		Milky	LED	8-30	2	145	>90	54	Chrome, gold, matt silver, white	10
9485s	Nova	Switch	Milky	LED	8-30	2	145	>90	54	Chrome, gold, matt silver, white	10
9485rv	Nova	Red/White light	Milky	LED	8-30	2	145	>80	54	Chrome, gold, matt silver, white	10
9469	Nova Touch master	Master function	Milky	LED, lens 50°	12-14	1	64	>80	66	Chrome, gold, matt silver, white	10
9470	Nova Touch	Single touch	Milky	LED, lens 50°	12-14	1	64	>80	66	Chrome, gold, matt silver, white	10
9474	Nova Slave	Slave to 9469	Milky	LED, lens 50°	12-14	1	64	>80	62	Chrome, gold, matt silver, white	10
9472	Nova Power LED		Transparent	CREE Power LED 30°	8-30	3,3	240	>80	21	Chrome, gold, matt silver, white	16
9473	Nova Power LED		Transparent	CREE Power LED 50°	8-30	3,3	240	>80	21	Chrome, gold, matt silver, white	16
9777ring	Distance frame	For LED, 15 mm								Chrome, gold, matt silver, white	

All LED models without switch are available with square frame.

Downlights

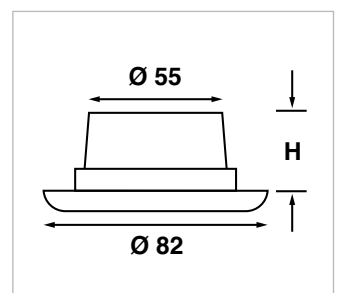

Art.	Product	Function	Light source	Volt (V)	Power (W)	Lumen	CRI	IP	Colour	H (mm)
9476	Pinto SMD		LED	8-30	2	150	>90	21	Chrome, White	30
9476s	Pinto SMD	Switch	LED	8-30	2	150	>90	21	Chrome, White	30
9476rv	Pinto SMD RV	Red/White Light	LED	8-30	2	150	>80	21	Chrome, White	30
9476rvs	Pinto SMD RV	Switch Red/White Light	LED	8-30	2	150	>80	21	Chrome, White	30
9476vv	Pinto SMD	White/warm white	LED	8-30	2	40/150	>80/90	21	Chrome, White	20
9476vvs	Pinto SMD	White/warm white, switch	LED	8-30	2	40/150	>80/90	21	Chrome, White	20
9468	Pinto Touch	Single touch	LED lens, 50°	12-14	1	64	>80	66	Chrome, White	30
9471	Pinto L	Slave to 9466	LED lens, 50°	12-14	1	64	>80	62	Chrome, White	30
9466	Pinto Touch Master	Master function	LED lens, 50°	12-14	1	64	>80	66	Chrome, White	30
9477	Pinto Power LED		CREE Power LED, 30°	8-30	3,3	240	>80	21	Chrome, White	30
9479	Pinto Power LED		CREE Power LED, 50°	8-30	3,3	240	>80	21	Chrome, White	30
94675	Pinto MR11 LED		LED MR11	8-30	1,2	120	>80	21	Chrome, White	30

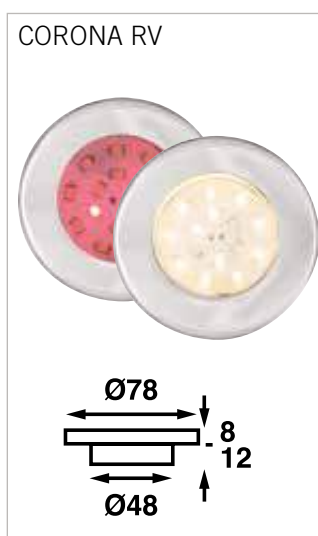
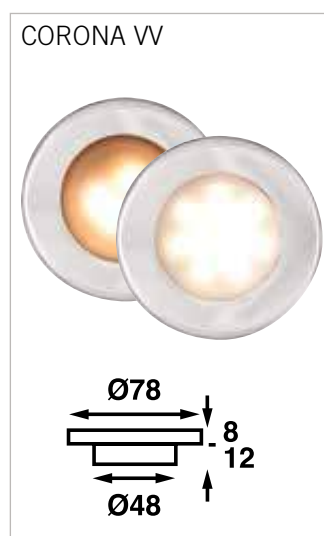

Art.	Product	Function	Light source	Volt (V)	Power (W)	Lumen	CRI	IP	Colour
9797	Corona		LED	8-30	2	150	>90	66	Chrome, brushed steel, polished steel, white
9797-1	Corona		LED	8-30	2	150	>90	66	Chrome, brushed steel, polished steel, white
9797vv	Corona	White/warm white	LED	8-30	2	40/150	>90	66	Chrome, brushed steel, polished steel, white
9797rv	Corona RV	Red/White light	LED	8-30	2	150	>80	66	Chrome, brushed steel, polished steel, white
9797Frame	Frame	Frame							Transparent

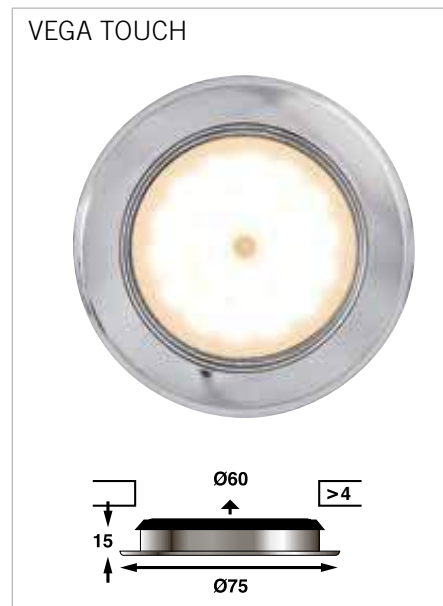
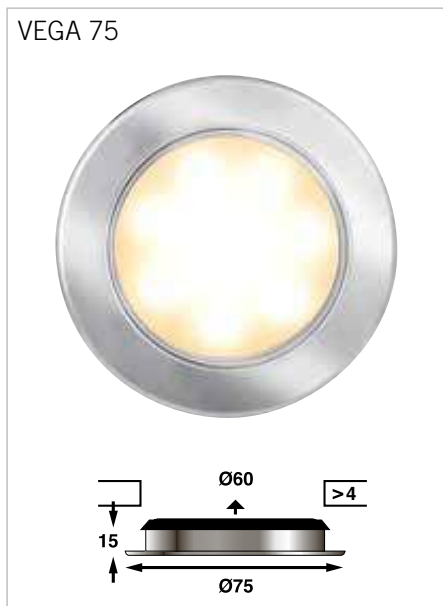

Art.	Product	Function	Light source	Volt (V)	Power (W)	Lumen	CRI	IP	Colour
9693	Vega 75	Transparent glass	LED	8-30	2	150	>90	21	Chrome, Matt chrome, White
9693-1	Vega 75	Opal glass	LED	8-30	2	150	>90	21	Chrome, Matt chrome, White
9692	VegaL	Slave to 9696	LED Lens 50°	12-14	1	64	>80	62	Chrome, Matt chrome, White
9696	Vega touch Master	Master function	LED Lens 50°	12-14	1	64	>80	66	Chrome, Matt chrome, White
9694	Vega touch	Single Touch	LED Lens 50°	12-14	1	64	>80	66	Chrome, Matt chrome, White



Art.	Product	Function	Light source	Volt (V)	Power (W)	Lumen	CRI	IP	Colour	Cone ratio (CR)
9463	Neptun 50	Inclinable +/- 35°	CREE Power LED, 50°	8-30	3,3	240	>80	21	Brushed steel	1.0
9462	Neptun 30	Inclinable +/- 35°	CREE Power LED, 30°	8-30	3,3	240	>80	21	Brushed steel	0.5
9464	Neptun 15	Inclinable +/- 35°	CREE Power LED, 15°	8-30	3,3	240	>80	21	Brushed steel	0.3

Downlights

SATURN TOUCH

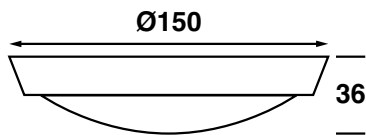

SUN

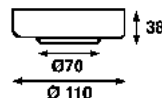

TARGA

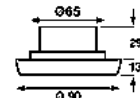

SATURN

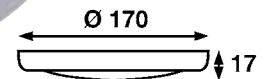

MARS

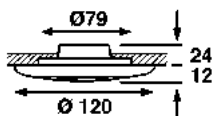

JUPITER



Art.	Product	Function	Light source	Volt (V)	Power (W)	Lumen	CRI	IP	Colour
9415	Saturn touch	Touch Switch	LED	12	3,5	225	94	21	Matt Chrome, White
9416	Saturn	Switch	LED	12	3,5	210	94	21	Chrome, White
8716	Saturn	Switch	Halogen	12	10	100		21	Chrome, White
9411	Sun	Switch	LED	8-30	2	150	>90	21	Chrome, White
8311	Sun	Switch	Halogen	12	10	100		21	Chrome, White
9490	Targa		LED	8-30	2	150	>90	66	Chrome, White
8990	Targa		Halogen	12	10	100		66	Chrome, White
9412	Mars		LED	8-30	2	150	>90	21	Chrome, White
9412s	Mars	Switch	LED	8-30	2	150	>90	21	Chrome, White
8812	Mars		Halogen	12	10	100		21	Chrome, Gold, White
8812s	Mars	Switch	Halogen	12	10	100		21	Chrome, White
9550	Jupiter	Spring	LED	10-30	7,5	400	>80	21	Matt silver

SQUARE 80

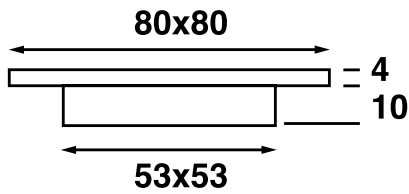

SQUARE 50

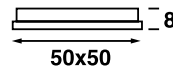

MINOR

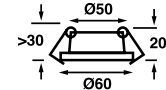

DISTANCE FRAME

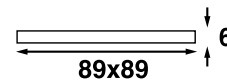

COMET

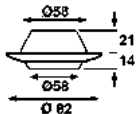

COMET

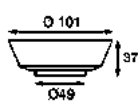

EYELIGHT

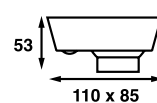

Art.	Product	Function	Light source	Volt (V)	Power (W)	Lumen	CRI	IP	Colour
9790	Square 80		LED	8-30	1,7	105	>80	21	Matt chrome, White
9480	Comet		LED	8-30	2	150	>90	21	Chrome, White
9480s	Comet	Switch	LED	8-30	2	150	>90	21	Chrome, White
8780	Comet		Halogen	12	10	100		21	Chrome, White
8780s	Comet	Switch	Halogen	12	10	100		21	Chrome, White
9410	Comet	Switch	LED	8-30	2	150	>90	21	Chrome, Matt silver, White
8710	Comet	Switch	Halogen	12	10	100		21	Chrome, Gold, White
9441	Eyelight	Switch	LED	8-30	1,2	120	>90	21	Matt silver, White
8341	Eyelight	Switch	Halogen	12	10	100		21	White
9461	Minor		LED	8-30	2	150	>90	21	Chrome, Matt silver, Silversand
9695	Square 50		LED	12	0,3	30	>80	66	Matt chrome, White
9695-1	Square 50	Milky	LED	12	0,3	30	>80	66	Matt chrome, White
9790Frame	Distance frame	Square 80							Transparent



Courtesy lights

Add a personal touch to your boat, using dots on deck or underwater lights. Make an impressive and exciting impact, to a relative small effort.



Courtesy lights

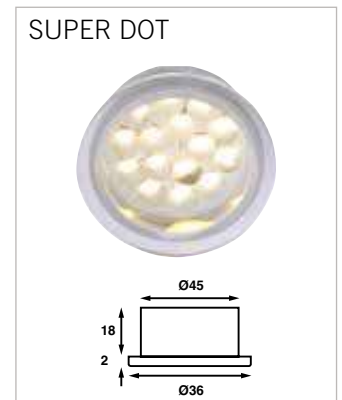
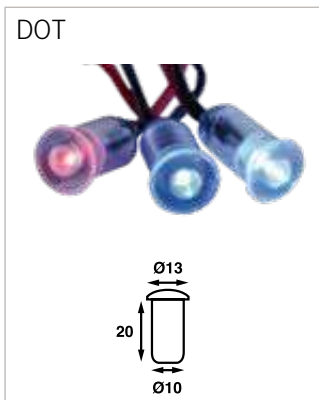

Art.	Product	Function	Light source	Volt (V)	Power (W)	Lumen	CRI	IP	Colour
9680-1	Gleam		LED	12	0,4	22	>80	66	Matt chrome, White
9681-1	Gleam	Globe shape	LED	12	0,4	22	>80	66	Matt chrome, White
9690	Vega 48	Clear glass	LED	12	0,4	22	>80	66	Brushed steel
9690-1	Vega 48	Milky	LED	12	0,4	22	>80	66	Brushed steel
8870	Steplight	White light	LED	12	0,25			66	Chrome, White
8871	Steplight	Blue light	LED	12	0,25			66	Chrome, White
8872	Steplight	Red light	LED	12	0,25			66	Chrome, White
9691	Vega 48 Square	Clear glass	LED	12	0,4	22	>80	66	Brushed steel
9691-1	Vega 48 Square	Milky	LED	12	0,4	22	>80	66	Brushed steel
9491	Targa Cap		LED	8-30	2	150	>90	66	Chrome, White
8991	Targa Cap		Halogen	12	10	100		66	Chrome, White
8878	Dot	White, Blue, Red Light	LED	12	0,15			66	Transparent
8878-1	Dot Opal	White, Blue, Red Light	LED	12	0,15			66	White
8879	Dot 30		LED	12	0,5			66	Chrome, Matt silver, Transparent
8880	Super Dot		LED	12	0,6	50	>80	67	Transparent



Underwater lights

Illuminate your boat and the surrounding water to create ambience and spectacular impressions around the boat, or the jetty.

Underwater lights

AQUADISC 1000

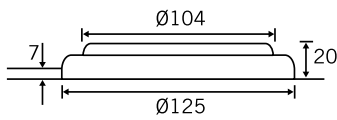

AQUADISC 100

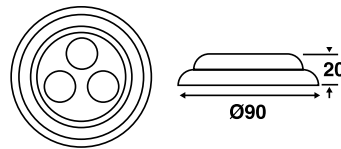

AQUADISC PLATE



Bright underwater lighting intended for surface mounting.



The light is IP68 classified, has great under-water performance and is easily mounted on the boat, in the pool or around the jetty. Manufactured in acid-proof stainless steel and available in white or blue light.



Aquadisc Plate is a plastic plate for mounting Bât-systems underwater light, designed with clips so that it can be easily attached to an existing ladder.

Art.	Product	Function	Light source	Volt (V)	Power (W)	Lumen	CRI	IP	Colour
9575v	Aquadisc 100	White light	LED	12/24	9	650	>80	68	Stainless steel
9575b	Aquadisc 100	Blue light	LED	12/24	9	650	>80	68	Stainless steel
9555v	Aquadisc 1000	White light	LED	12/24	16	1120	>80	68	Stainless steel
9555b	Aquadisc 1000	Blue light	LED	12/24	16	1120	>80	68	Stainless steel
9560	Aquadisc plate	Mounting on ladder							White (370x140 mm,c/c 240-345 mm)



Functional lights

Use special bright functional LED lighting in areas that need to be lit up to a maximum, such as the engine room, cupboards, anchor lift compartments, or on deck.



Functional lights



U-PRO SYSTEM

A flexible system of work lights built around an aluminium tube with a built-in powerful LED light. The tube can be rotated 360 degrees and varies in length. U-Pro is available in two standard sizes, 230 mm and 470 mm with a switch and a variety of mounting fittings. Is also available as wardrobe lighting.

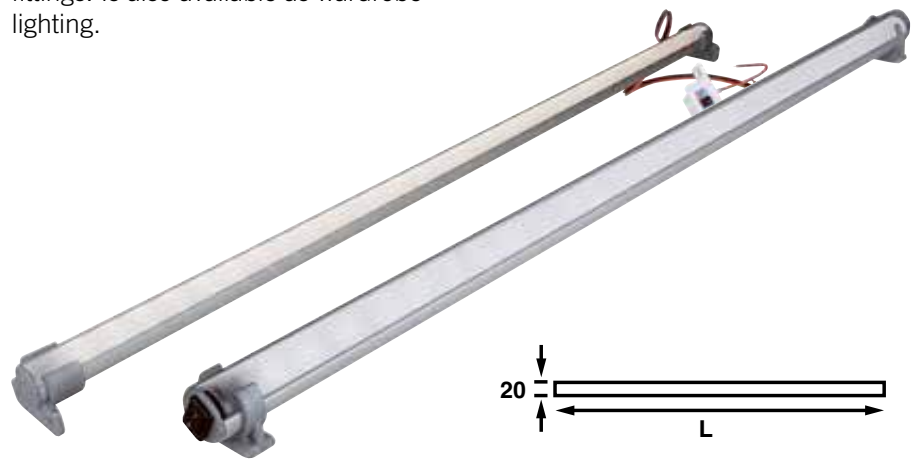

<p>9246-U1</p> 	<p>9246-U2</p> 	<p>9246-W1</p> 	<p>9246-W2</p> 	<p>9246-W3</p>  <p>150 mm</p>	<p>WARDROBE SWITCH</p>  <p>Included in U-PRO Wardrobe</p>
--	--	--	---	--	--

Art.	Product	Function	Light source	Volt (V)	Power (W)	Lumen	CRI	IP	Length mm (L)
9247-230Us	U-Pro 230	Switch	LED	12	2,3	150	94	21	230
9247-480Us	U-Pro 480	Switch	LED	12	4,7	300	94	21	470
9247W400	U-Pro Wardrobe	Wardrobe switch	LED	12	1,5	95	94	21	300-400
9247W500	U-Pro Wardrobe	Wardrobe switch	LED	12	2	125	94	21	400-500
9247W600	U-Pro Wardrobe	Wardrobe switch	LED	12	2,5	160	94	21	500-600
9246-U1	U-Pro Fitting								
9246-U2	U-Pro Fitting								
9246-W1	U-Pro Wardrobe Fitting								
9246-W2	U-Pro Wardrobe Fitting								
9246-W3	U-Pro Wardrobe Fitting								150

Functional lights

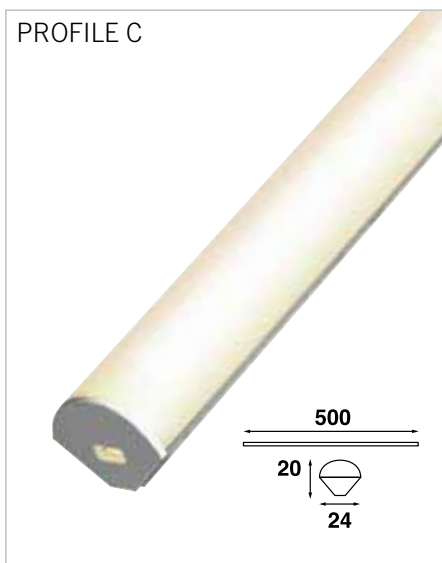

Art.	Product	Function	Light source	Volt (V)	Power (W)	Lumen	CRI	IP
9249	Profile C	Corner mounting	LED	12	4,8	325	94	21
9254	Profile D	500 mm	LED	12	4,8	325	94	66
9255	Profile D	1000 mm	LED	12	9,6	650	94	66



Art.	Product	Function	Light source	Volt (V)	Power (W)	Lumen	CRI	IP	Included
7511	LEDrail	500 mm	LED	12	6,5	496	80	65	TubeClips
7512	LEDrail	1000 mm	LED	12	13	993	80	65	TubeClips
75105	Plug II	250 mm, 16A		12					
75106	Cable	3 m							
75107	Cable	5 m							

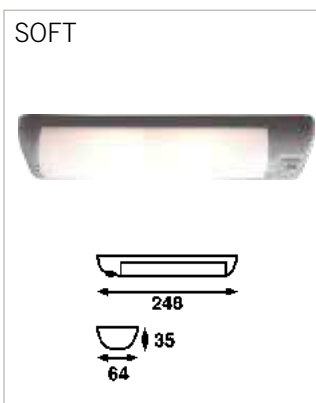
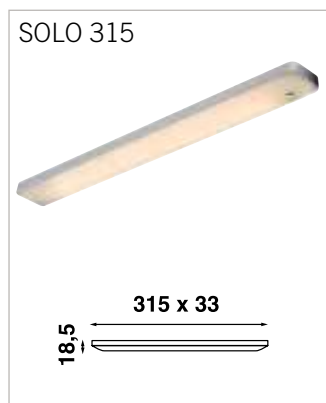
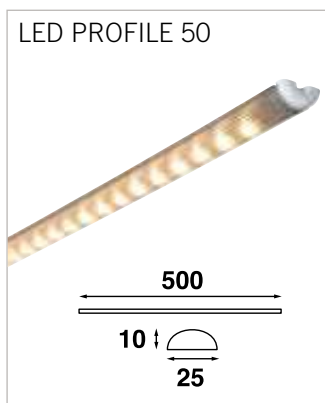

Art.	Product	Function	Light source	Volt (V)	Power (W)	Lumen	CRI	IP	Colour
9494	Opti		LED	8-30	2x2	300	>90	21	White
8499	Opti		Halogen	12	2x10	200		21	White
94611	Square	Switch	LED	8-30	1,2	80	>80	21	White
8611	Square	Switch	Halogen	12	10	100		21	White
94930	Smart	Wardrobe switch	LED	8-30	1,2	80	>80	21	White
8930	Smart	Wardrobe switch	Halogen	12	5	50		21	White
94330	Doorlight	Wardrobe switch	LED	8-30	1,2	80	>80	21	White
8330	Doorlight	Wardrobe switch	Halogen	12	5	50		21	White
9241	Led Profile 50		LED	12	2,5	160	94	21	White
9245	Solo 315 Led		LED	12	1,5	95	94	21	White
9245s	Solo 315 Led	Switch	LED	12	1,5	95	94	21	White
9025	Soft	Switch	LED	12	0,9	57	94	21	Matt silver, Silversand, White

Functional lights



Art.	Product	Light source	Volt (V)	Power (W)	Lumen	CRI	IP	Colour
9556	Workinglight	LED	9-36	11	840	>80	67	White
94880	Decklight	LED	8-30	2	150	>90	66	Transparent
9557	Mastlight	LED	9-36	11	920	>80	67	White
9558	Mastlight Housing							Black

Navlights

NAVLED

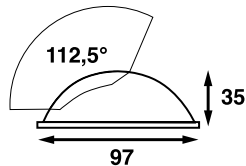

DOUBLE NAVLED

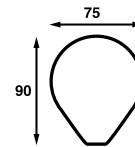

TELESCOPIC NAVLED

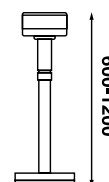

BATTERY NAVLED

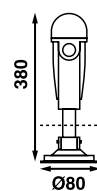

NAVLED TOP

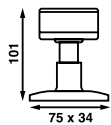

NAVLED STERN

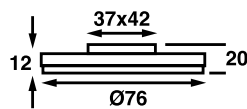

Art.	Product	Function	Light source	Volt (V)	Power (W)	Certificate	IP	Colour
9001	Navled	Sb/Port	LED	12	2,1	USCG < 12 m	67	Chrome
9009	Navled	Sb/Port	LED	12	2,1	USCG < 12 m	67	White
9002	Double Navled		LED	12	2,2	USCG < 12 m	67	Chrome, White
9004	Telescopic Navled	360°	LED	12	1	USCG < 12 m	67	Chrome
9003	Battery Navled	360°	LED			USCG < 7 m, 7 knots	65	White
9001v	Navled top	360°	LED	12	1	USCG < 12 m	67	Chrome
9009v	Navled top	360°	LED	12	1	USCG < 12 m	67	White
9001a	Navled stern		LED	12	1,2	USCG < 12 m	67	Chrome
9009a	Navled stern		LED	12	1,2	USCG < 12 m	67	White



Light switches

With the full range of standard and special lighting comes a complete series of switches, sockets and dimmers – all manufactured to work perfectly together. This enables you to set your lighting to create ambience on board.

Light switches

DIMMERS

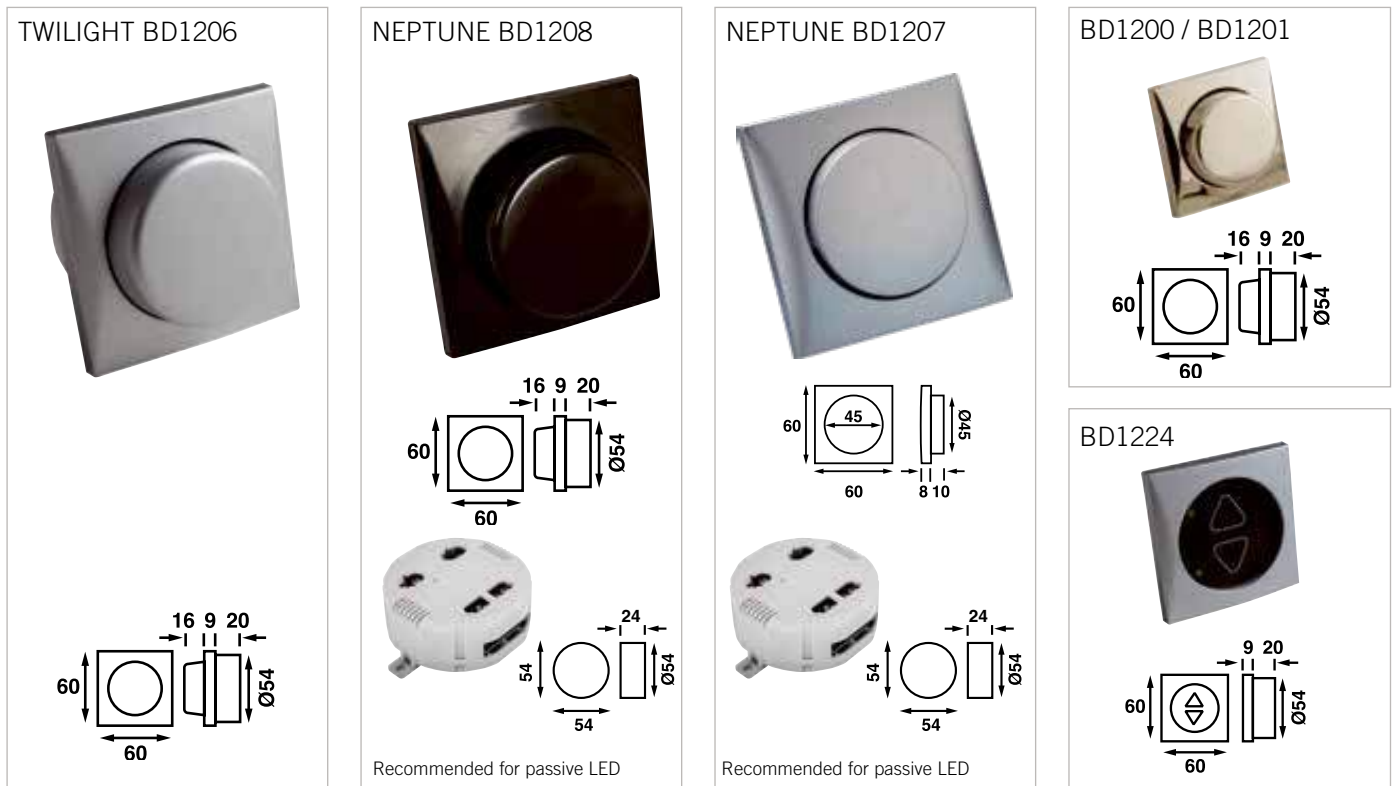

Art.	Product	Function	Input V	Output V	Max effect W	Max A	IP	Colour
BD1200	Twilight	Halogen	8-30	12/24	60	5	21	Chrome, Gold, Matt silver, Silversand, White, Black
BD1201	Twilight	Halogen	8-30	12/24	100	8	21	Chrome, Gold, Matt silver, Silversand, White, Black
BD1206	Twilight LED	LED	8-30	12	25	2	21	Chrome, Gold, Matt silver, Silversand, White, Black
BD1207	Neptune	LED, Rocker push button	12/24	12/24	100	8	21	Chrome, Matt silver, White
BD1208	Neptune	LED	12/24	12/24	100	8	21	Chrome, Gold, Matt silver, Silversand, White, Black
BD1210	Dimmer unit	LED	12/24	12/24	100	8	21	N/A
BD1224	Dimmer	Halogen	12-28	12/24	100	8	21	Chrome, Gold, Matt silver, Silversand, White, Black

LED VOLTAGE STABILIZER

The different electrical equipment on board usually requires different voltage supplies. Large fluctuations and spikes in the voltage supply is also common due to the use of different equipment, like starting engines, windlasses or charging the batteries etc.

In order to maximize the lifespan of your LEDs, the stabilizer protects the system and equipment from these occurrences and also enables you to have a 12v system within your 24v system, giving you a wider range of possibilities to design your lighting.

LED VOLTAGE STABILIZER



Performance:

- Protection of fast transients on input and output.
- Overvoltage protection for long-term overvoltage.
- Short circuit protection on output and input.
- Stabilization of output voltage: adjustable from 6 to 12.5V
- Input voltage 30V max.
- EMC filtering in and out for cables and shielding of electronic equipment according to CE standard EN55022B
- Stabilizes up to 75W at 12.5V output, hence protecting entire light circuits with just one stabilizer

Art.	Product	Function	Input V	Output V	Max effect W	Max A	IP	Colour
5934	Stabilizator	Stabilizator LED	12-30	6-12.5	72W	6	21	Black

Light switches



B4870-1

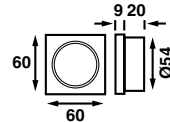

B4870-2

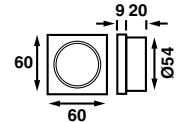

BE5850-1

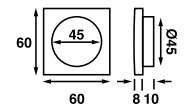

BE5850-2

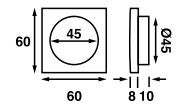

BE5890-1

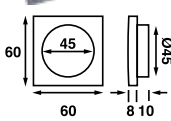

BE5880-1

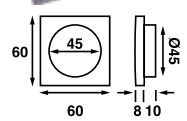

BE5880-2

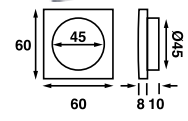

BE5895



Art.	Manufacturer	Function	Colour
B4870-1	Frilight	Single switch	Chrome, Gold, Matt silver, Silversand, White, Black
B4870-2	Frilight	Double switch	Chrome, Gold, Matt silver, Silversand, White, Black
BE5850-1	Berker	Single switch	Chrome, Matt silver, White
BE5850-2	Berker	Double switch	Chrome, Matt silver, White
BE5890-1	Berker	Changeover	Chrome, Matt silver, White
BE5880-1	Berker	Single rocker push button	Chrome, Matt silver, White
BE5880-2	Berker	Double rocker push button	Chrome, Matt silver, White
BE5895	Berker	Double frame	Chrome, Matt silver, White

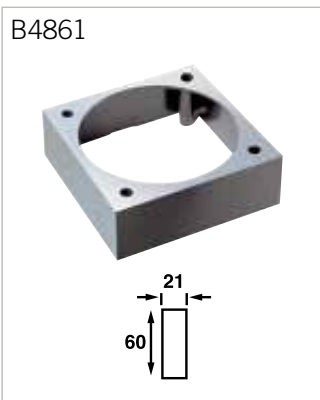
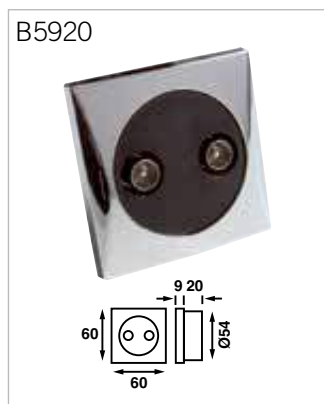
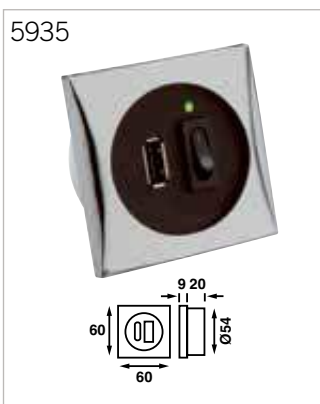
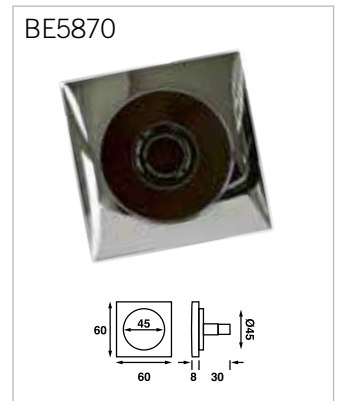
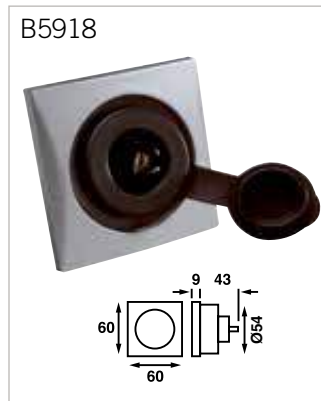
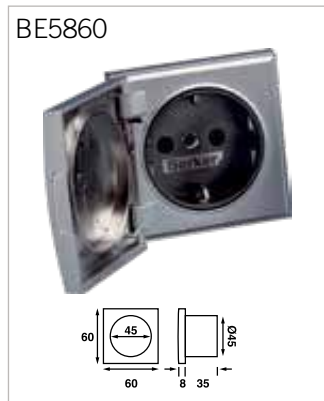
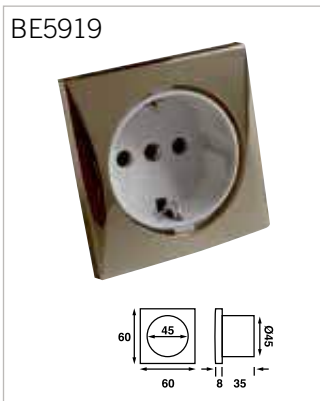

Art.	Function	Colour
BE5919	230V Socket	Chrome, Gold, Matt silver, Silversand, White, Black
BE5860	230V Socket Berker with cover, 16A	Chrome, Matt silver, White
B5918	12V Socket	Chrome, Gold, Matt silver, Silversand, White, Black
BE5870	12V Socket Berker	Chrome, Matt silver, White
5935	USB Socket Input 12-30 output, 5V 2A	Chrome, Gold, Matt silver, Silversand, White, Black
B5920	TV Socket	Chrome, Gold, Matt silver, Silversand, White, Black
5932	12V Socket 16A	Black
5930	12V Plug 16A	Black
B4861	Frame (Not for Berker)	Chrome, Gold, Matt silver, Silversand, White
8930-5	Wardrobe switch	White

Light sources



Art.	Light source	Volt (V)	Power (W)	Lumen	CRI	Kelvin	Colour
94G4B6	LED	8-30	1,3	110	>90	3000	White
94G4B	LED	8-30	1,7	140	>90	3000	White
94G4S6	LED	8-30	1,3	110	>90	3000	White
94G4S	LED	8-30	1,7	140	>90	3000	White
94G4Sb	LED	8-30	1,7	N/A	>90	N/A	Blue
94G4Sr	LED	8-30	0,9	110	>90	N/A	Red
94G4Srv	LED	8-30	1,4	N/A	>90	3000	Red and White
94G4V	LED	8-30	1,2	80	>90	3000	White
94MR11LED	LED	8-30	2,5	160	>80	3000	White
94MR16LED	LED	8-30	2,3	200	>80	3000	White
BAY15D	LED	8-30	2,4	180	>90	3000	White
94BA15S	LED	8-30	0,7	60	>90	3000	White
94BA15D	LED	8-30	0,7	60	>90	3000	White
94SPOOL1	LED	8-30	0,7	50	>90	3000	White
94SPOOL2	LED	8-30	1,5	100	>90	3000	White
94SPOOL3	LED	8-30	0,5	40	>90	3000	White
94SMDCARD	LED	8-30	2	150	>90	3000	White
94SMD4949	LED	8-30	1,66	105	>80	3000	White
G4	Halogen	12	10	100			
MR11	Halogen	12	10	120			
MR16	Halogen	12	10	120			

Transformers

TRAFO 2



TRAFO 4



TRAFO 5



Art.	Product	Input V	Output V	Current A	Power (W)	IP
TR02	Trafo 2	100-240	12	1,5	18	21
TR04	Trafo 4	170-250	12	2,5	30	67
TR05	Trafo 5	220-240	12	2,5	30	21

Power calculation

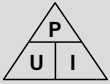

P (power) =
U (voltage) x I (current/ampère)

Examples:

$$\begin{aligned} \text{Power}(P) &= U \times I \\ \text{Current}(I) &= P / U \\ \text{Voltage}(U) &= P / I \end{aligned}$$

$$\begin{aligned} 3W &= 12V \times 0,25A \\ 0,25A &= 3W / 12V \\ 12V &= 3W / 0,25A \end{aligned}$$



prebit®



Båtsystem provide a series of exclusive LED lights from German brand Prebit in Sweden. Technology, design, control electronics and even programming are proprietary developments, built upon extensive "light-know-how". The high product quality is not only about innovative technology, but also the

unadulterated style: solid brass, aluminium, matt or shiny chrome – or with a 24-carat gold plating. The concealed fixing is an essential part of the design concept and much attention have been paid to the details.

Visit www.batsystem.se for a complete range of Prebits products.

prebit®

