

Manufacturer of Marine Lights, Hardware and Accessories

**PERKO®**

*We Make it Right, Right Here!!®*

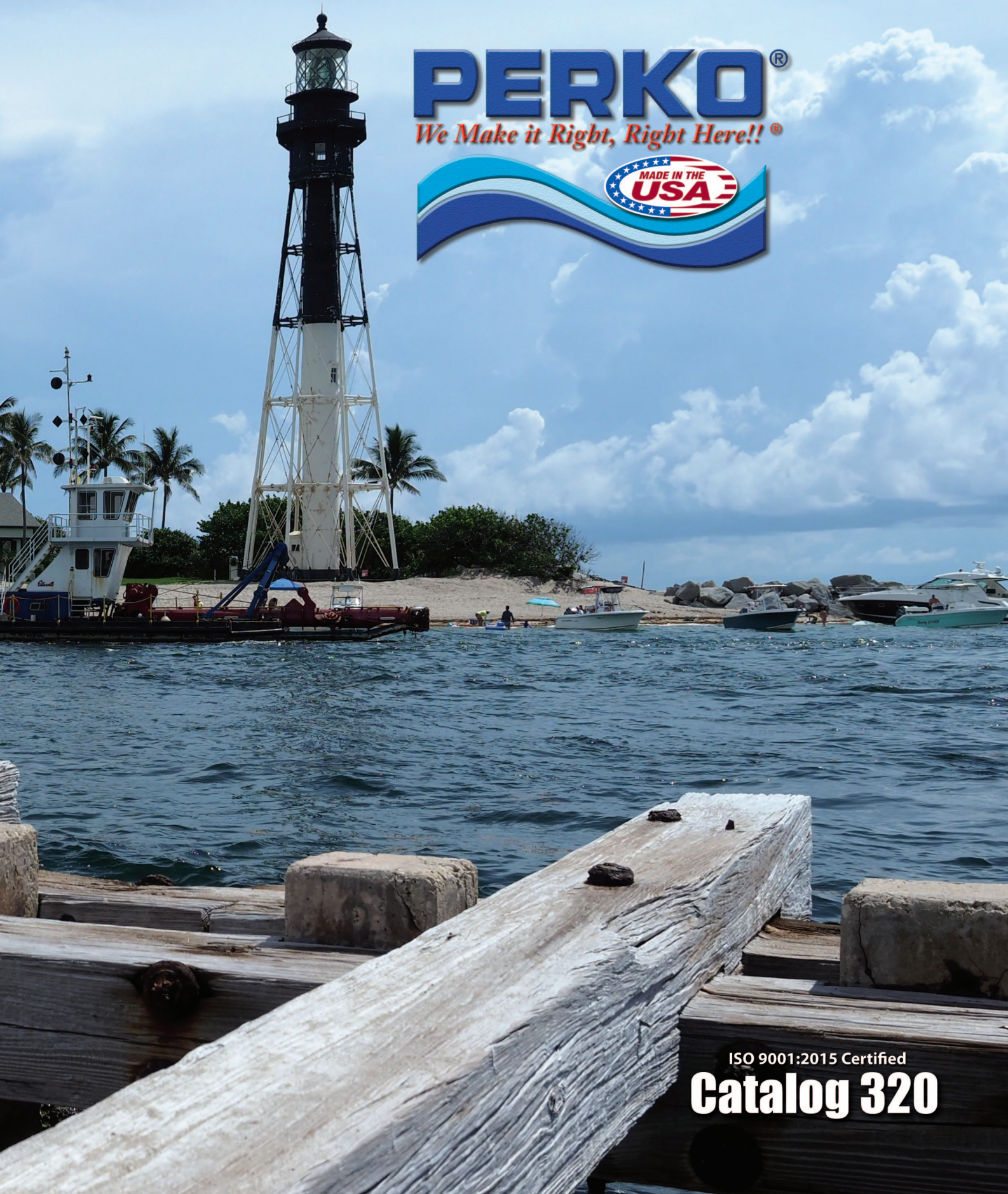

ISO 9001:2015 Certified

**Catalog 320**

## COVER PHOTOGRAPH

### *Hillsboro Inlet Lighthouse*

Pompano Beach, FL

Cover Photos By: Richard A. Cozier

**History:** Hillsboro Point was designated as hazardous for the safe navigation of ships in 1855 and federal designation was sought. In 1901, the United States Lighthouse Board persuaded Congress to authorize the construction of a lighthouse in the dark area between Jupiter Inlet Light and Fowey Rocks Light. The official order, that was approved on February 12, 1901, called for a "first-order light at or near Hillsboro Point...at a cost not to exceed \$90,000. The full funding to build the lighthouse was appropriated in 1903.

Soon after the light was operational there were unexplained reports of fires in the Everglades began to come in. The cause was the lens, when stopped in the morning at just the right position, it would focus the sunlight west towards the wetlands. A landward baffle was installed. This also shielded nearby residents from the bright light at night.

During the 1926 Miami hurricane the lighthousekeeper stood a 32-hour watch, keeping the light burning while fearing the lighthouse would fall. It stood but 20 feet of sand was washed out from under it. The lighthouse beach patrol spotted a German U-boat in 1943, during World War II. The submarine was reportedly sunk, but no wreck has been documented.

In 1974 the lighthouse was fully automated. The Hillsboro Inlet Light Station was listed on the U.S. National Register of Historic Places on February 16, 1979. The lighthouse and buildings are little altered from their original construction in 1907.

In the second half of the 20th century, this inlet became an increasingly busy waterway. Hillsboro Inlet Light is considered one of the most powerful lights in the world with a beam that can be seen for 28 nautical miles.

**The Lighthouse:** The structure is an octagonal pyramidal, iron skeleton tower, built by a Chicago steel firm for the 1904 St. Louis World's Fair, with central stair cylinder; the lower third of the structure is painted white; the upper two-thirds and the lantern are painted black. The paint scheme was selected for daytime visibility, the lower portion white to stand out among trees, the top black to contrast with the daytime sky. Its second-order Fresnel lens emits a light measuring 5.5 megacandelas and stands 135 feet above sea level. The lens is 9 feet in diameter and weighs 3,600 pounds. The original light was an incandescent oil vapor lamp fueled with kerosene and was replaced in the 1920s with four 250 watt incandescent bulbs. At 550,000 candlepower, it was then the most powerful lighthouse on the east coast of the United States. It could be seen from 35 miles away at sea on a clear night. The electrical system was upgraded in 1932 allowing the same amount of light to be generated with three bulbs instead of four. In 1966, two 1,000 watt xenon high pressure lamps were installed, bringing the light to 5.5 megacandelas, making it the third most powerful lighthouse in the world at that time. In 1977 it was the most powerful light in Florida. Automated in 1974, the light acts both as a coastal navigational aide and as a support to local water traffic.

The light assembly rotated on a liquid mercury reservoir, allowing up to one rotation per 15 seconds. Rotation was driven by a weight on ropes through a gear mechanism. The amount of weight determined the speed of rotation. The weight had to be hand cranked back up about each hour and a half. Several times a night fuel was carried by hand up the 175 steps.

**Restoration:** In 1992 the big light was turned off, due to the failure of the rotating mechanism, and a smaller temporary light was installed on the railing. This light was only visible for 10 nautical miles. The Coast Guard had planned to remove the original fresnel lens but a successful local campaign led to the restoration. The Hillsboro Lighthouse Preservation Society was founded 1997 as a part of the campaign. About 200 people joined the preservation society at that time. The historical value of keeping the lens in the lighthouse and the importance of the bright light as an aid to navigation were cited in the effort to persuade the Coast Guard to restore the light. The cost of the restoration was \$143,000.

The old mechanism contained 400 pounds of mercury which was replaced by a specially designed ball bearing system. The mercury was removed in 1995. The large light was relit on January 28, 1999. One month after the lamp was relit the bearing system failed. The system was redesigned and repaired and the light was turned on once again on August 18, 2000. As of 1999 the fresnel lens was one of nine in active use in the United States.

**Modern times:** The Hillsboro Lighthouse Preservation Society took over maintenance from the Coast Guard in 2008. Surrounded by water on three sides, the lighthouse is constantly threatened by coastal erosion. Hurricane Irma washed a large amount of sand from under the foundations of the lighthouse and damaged the buildings and the site. The footings and foundation were fractured. The preservation society is raising funds for a plan to build a granite spur jetty to protect the site.

The Hillsboro Lighthouse Museum and Information Center opened in March 2012 on the grounds of Hillsboro Inlet Park in Pompano Beach. The museum houses artifacts related to the lighthouse and a ten-foot-tall stone statue of the Barefoot Mailman.





## Catalog No. 320 - For Recreational and Pleasure Boats

<u>Section</u>	<u>Pages</u>
1. Preface: The Perko Story, Modern Facilities, Sales Policy, General Information and Sales Representatives	2 to 10
2. Navigation Lights	11 to 62
3. Lighting Fixtures, Utility Lights & Bulbs	63 to 69
4. Searchlights & Fog Bells	70 to 74
5. Battery Switches and Electrical Components	75 to 86
6. Underwater Hardware	87 to 106
7. Deck Plates, Fills, Tank Vents, and Ventilators	107 to 128
8. Deck and Cabinet Hardware, Hinges, Locks & Latches	129 to 177
9. Fishing Equipment	178 to 181
10. Numerical & Alphabetic Indexes	182 to 192



Proudly Made in America for Over 100 Years

### Manufacturer of Ship and Boat Equipment

**Street Address:**

16490 Northwest 13th Avenue  
Miami, Florida 33169-5707

**Telephone Number:** (305) 621-7525

**Fax Number:** (305) 620-9978



**Mailing Address:**

P.O. Box 64000D  
Miami, Florida 33164-0510

**e-mail:** sales@perko.com

**Website:** www.perko.com

## The PERKO® Story



**Frederick Perkins**  
**Founder 1907-1947**

**4th Generation**



**Louis E. Perkins**  
**Co-Founder/President 1947-1964**



**Marvin Perkins**  
**President 1964-1997**  
**Chairman 1997 to 2018**



**Frederick M. Perkins**  
**President 1997-Present**



**Cameron Perkins**  
**1999-Present**



**Deborah Hilyard**  
**2002-Present**

**5th Generation**

Frederick Perkins (Mendel Persky) born in Russia in 1874 and schooled as a machinist (tool & die maker) in Germany, immigrated to this country in 1889 at the age of 15 and became a naturalized U.S. citizen in 1898. In the early 1900's, Frederick started the original family business as a tool and die manufacturer out of his basement, as F. Persky & Co., at 49 Elizabeth Street in New York City.

In 1907, Fred Perkins was joined by his cousin Max Persky who was also a machinist. By 1910 the business had grown, and they moved down the street to 52 Elizabeth Street. At that time the company had approximately 14 employees and was established in the business of making small machine parts, tubular type bicycle pumps, head lights for automobiles and small

lanterns which the dime stores filled with candy. When a customer did not pay him for a set of marine lantern dies, Fred started marketing the lights he manufactured from that set of tools.

Between 1910 and 1912 the National Marine Lamp Company was formed by a combination of F. Persky & Company, H.A.J. Helvig and Company, and American Lamp Works. The main headquarters for National Marine Lamp was located at 23 Brook Street in Forestville, Connecticut in a very large building that once had been a thread mill. They also maintained a sales office in New York City.

By 1913 Fred Perkins had moved to Connecticut and F. Persky & Company ceased independent operations. During that same year, Fred Perkins was listed in the

company annual report as the president of National Marine Lamp Company.

From 1913 until late 1916, Fred Perkins operated as the head of National Marine Lamp Corp. In late 1916, he left that firm and opened a new company, Perkins Marine Lamp Company, which was incorporated in early 1917. The company set up operations in the remote farmlands of Brooklyn and operated in the Brooklyn, New York facility at 1943 Pitkin Avenue until 1959. The original plant consisted of one three story building, of which the two top floors were leased out to independent operations. New products were added to the line and sales activities expanded beyond the Northeast. Perko offered cast bronze lights and hardware, first to the maritime industry, then to the growing pleasure boat market.



## The PERKO® Story

It was also around the time of Fred Perkins' move to Brooklyn in 1916 that his son, Louis E. Perkins, began working with the company full time. In 1922, the now famous "PERKO" trademark was introduced.

In the late 1920's, the company introduced copper and nickel plated products from its own plating department. When chromium plating was perfected in the 1930's, the first Perko chromium-plated hardware appeared. As Perko's reputation for quality increased, the company's manufacturing facility expanded and enjoyed exceptional growth into the 1930's. It was during the 1930's that Perko established itself as a full-time manufacturer of marine lights, hardware, and accessories for the pleasure boating market. This tremendous growth created the need for more facilities. The original one-story manufacturing plant in Brooklyn grew to five stories. Then six more buildings were added until finally there was no more room for expansion.

In 1932, the Perkins Marine Lamp Company corporate name was changed to Perkins Marine Lamp & Hardware Corporation, since by that time the company was becoming heavily involved in supplying the marine trade with not only navigation and decorative lights, but also a variety of hardware fittings for the maritime and pleasure boat market.

Louis Perkins became President in 1947 upon the passing of his father Frederick. It was also in that year that his son Marvin joined the firm. In 1959, Louis and Marvin decided to move the entire operation to a new facility in Miami, Florida. Lou's first objective at the new facility was to put everything under one roof. This meant the elimination of subcontractors and the addition of a whole range of in-house production capabilities—from mill material to finished product.

Also in 1959, Leroy F. (Roy) Hollenbeck joined Perko applying his background in manufacturing and production to assist in coordinating the layout and supervise construction of the new plant. Roy's experience in plating, engineering, and design helped to improve the product line and manufacturing techniques.

The new building opened in 1960 with approximately 78,000 square feet putting all the manufacturing and offices on one floor under one roof. That facility was expanded to 90,000 square feet with the addition of a non-ferrous foundry for brass, bronze, and aluminum casting in mid 1961.

By 1965, a 47,000 square foot extension was completed to house the sophisticated die-casting system that now produces zinc and bronze parts.

Marvin's son Fred Perkins, named after his great-grandfather, became the 4th generation of the Perkins family involved in the company and quickly established himself as one of the marine industry's most knowledgeable authorities on navigational light requirements. Fred started in 1969 while still attending school and became active on a full time basis in 1973. He was named assistant Vice President of manufacturing in early 1974 and in 1978 became company Secretary. His background in engineering and electronics proved to be a welcome asset to help keep the product line up to date. Over the years the company had become better known for its "PERKO" trademark. In 1976, it was decided to change the company name to Perko Incorporated.



In 1979, a 35,000 square foot plastics injection molding facility was added to enable production of all of the polymer products and components for the diverse product line.

Fred became president in 1997. Then in 1999, Fred's son Cameron joined the company and in 2002, his daughter Deborah joined the family business marking the 5th generation and setting the course for the future.

Today, PERKO is truly an integrated manufacturer, almost completely independent of outside vendors, with the exception of a few basic items such as light bulbs and electric wire. A whole range of complete in-house capabilities, from product design through manufacturing and assembly of finished products, enables us to eliminate most subcontractors and obtain better control of our product quality, cost, and delivery.

Our sand casting foundries help us control the production of our high quality brass, bronze, and aluminum castings, and offers assurance that the proper alloy is used for each job.

PERKO is the only domestic marine manufacturer producing die-cast bronze parts which are well known for strength, uniformity and quality.

Our diverse press department utilizes a variety of forming tools, including multi-stage, progressive tooling produced in our tool room. Our large, conventional machine shop includes many secondary operations such as drilling, tapping, and assembly. A separate machine shop houses a number of modern, high speed automatic chuckers for high volume items, and our three separate polishing divisions assure the correct finishing procedure for each product.

In 2005, our facility was rewired for a state-of-the-art computer network and enterprise resource planning (ERP) operation, which is taking us into the next century. Expansion continues with the substantial addition to our foundry of an Investment Casting operation. Our in-house printing, graphics, and pre-press department produces almost all of our printed materials from packaging materials, box labels, and instructions to full color catalogs and marketing materials. In total, careful planning over the years has enabled us to become virtually self sufficient in every department.

Throughout all of our operations, steps have been taken to efficiently assure production of the highest quality products. PERKO has been an ISO registered company since 1994. Our products are designed and manufactured to meet or exceed various standards, including ISO 9001-2015, USCG, UL, NMMA and other industry standards as well as our own quality specifications. Quality control is consistently maintained and every step forward, from our founding to the present day, has been undertaken with our customer in mind. Each PERKO product is thoroughly evaluated for safety, appearance, and function.

It has always been our objective to provide our customers with the very best in marine lights, hardware, and accessories at competitive prices. The marketplace has rewarded our emphasis on quality with ever increasing sales and reputation. Designed and built to the highest specifications, all PERKO products are backed with outstanding warranties and our commitment to excellence. It's a "PERKO Plus" you can count on!

To date, the PERKO facility spans 15 plus acres and over 440,000 square feet of manufacturing capability. As an American manufacturer, staying competitive today in a constantly changing global market place presents many challenges, but our vision is steadfast as we move into the next century of business. Perko maintains its commitment to quality and is proud of its heritage as an American success story for over 100 years.

## General Information

### PERKO® LIMITED WARRANTY

PERKO, INC. (PERKO) warrants to the original consumer-purchaser that PERKO'S products will be free from defective materials or workmanship, and that the PERKOPLATE/PERKO-KOTE finish will remain corrosion-free under normal use and service, for a period as shown below from the original purchase date:

Product Class	Duration
Products installed by a manufacturer as original equipment	1 year or duration of the original equipment manufacturer's general accessory warranty up to 5 years, whichever is longer
Emissions system components installed by manufacturer as original equipment	2 Years
Commercial products (and/or products used in commercial service) and searchlights	1 Year
Products not included above and which are purchased over-the-counter at a retail dealer	5 Years

ALL IMPLIED WARRANTIES, INCLUDING MERCHANTABILITY, ARE ALSO LIMITED IN DURATION TO THE WARRANTY PERIOD FROM THE ORIGINAL PURCHASE DATE.

PERKO SHALL NOT BE LIABLE FOR LOSS OF USE OF ANY OF ITS PRODUCTS, NOR FOR OTHER INCIDENTAL OR CONSEQUENTIAL COSTS, EXPENSES, OR DAMAGES INCURRED BY THE ORIGINAL PURCHASER OR BY ANY OTHER PERSON.

SOME STATES DO NOT ALLOW LIMITATIONS ON HOW LONG AN IMPLIED WARRANTY LASTS, SO THE ABOVE LIMITATION MAY OR MAY NOT APPLY TO YOU. SOME STATES DO NOT ALLOW THE EXCLUSION OR LIMITATION OF INCIDENTAL OR CONSEQUENTIAL DAMAGES, SO THE ABOVE LIMITATION OR EXCLUSION MAY OR MAY NOT APPLY TO YOU.

This warranty is void if the product warranted has been damaged by accident or unreasonable use, neglect, improper service, or other cause not arising out of defects in material or workmanship. Excluded from this warranty are electric light bulbs (lamps), sealed beam units, and fuses. Specific warranty statements made on the smallest unit package, on the individual instruction/installation sheets, or on price quotations which accompany certain specialty, custom or individual products shall supersede this warranty.

During the warranty period, your PERKO product will either be repaired or it will be replaced with a like product (at PERKO's option) without charge to the original consumer-purchaser, when returned prepaid and insured, with proof-of-purchase date to PERKO at our factory in Miami, FL. In the event of replacement, the replacement product will continue the warranty of the original product, or ninety (90) days, whichever is longer. **Important: For this Warranty to be effective, PERKO must be supplied with Proof-Of-Purchase date of the product.**

PERKO does not authorize any person or company to create for it any other obligation or liability in connection with any of its products.

### SALES POLICY

PERKO Products are sold through our established Distributors. We do not sell direct to the public or organizations. Therefore, possession of this catalog does not infer an offer to sell. Please contact your local marine supplier or visit our website [www.perko.com](http://www.perko.com) to find a supplier near you.

### PRICES AND TERMS

Our costs can change due to causes beyond our control. Therefore, our price list is only intended for the guidance of our customers and does not necessarily establish current prices. All prices are subject to change without notice.

Orders from our customers having no satisfactory history or credit rating with us must be prepaid. C.O.D. shipments will be made if a 25% deposit is sent with the order. Cash discounts do not apply to C.O.D. or C.I.A. shipments.

### DESIGNS

For the purpose of continuous improvement in our products, the designs and specifications are subject to change without notice.

### RETURN GOODS

A Repackaging Service Charge of \$10.00 net will apply to all broken packages. Products made to order are not returnable. Stock products in new, saleable condition are only returnable when permission has been granted by us, and are subject to handling and repackaging charges. Return shipping charges must be prepaid. Purchase date and invoice number are required when requesting an R.G.A. (Return Goods Authorization) number. Permission must be requested within 30 days after receipt of goods.

### SHIPPING INSTRUCTIONS

Customers should send specific shipping instructions; otherwise, we will use our own judgement in selecting route.

### SHIPMENTS

**F.O.B. our plant, Miami, Florida**, unless quoted otherwise. We are not responsible for damage, loss, or delay after goods are delivered to carrier. When loss or delay occurs, we will gladly assist in tracing or expediting, but such assistance is no criterion of responsibility.

When there is **loss or apparent visible damage** to a shipment when tendered for delivery, **do not** give the carrier a clear receipt. Note such damage on the carrier's delivery receipt and **have the driver sign the receipt.**

### CONCEALED DAMAGE OR LOSS

1. Advise the delivering carrier in writing as soon as discovered, or no more than 15 days after delivery, and request carrier to make an inspection.
2. **Retain**, for the carrier's inspection, the **container** and **all packaging** with which the damaged or lost material was packaged.
3. **Shortages** - Must be reported to us within 15 days after receipt of goods.



Items in this catalog identified with this symbol comply with the State of California **Prop 65** Safe-Harbor warning:

### WARNING:

These products can expose you to chemicals including lead and/or DINP which are known to the State of California to cause cancer and birth defects or other reproductive harm. For more information go to [www.P65Warnings.ca.gov](http://www.P65Warnings.ca.gov).



## Regional and International Sale Representatives

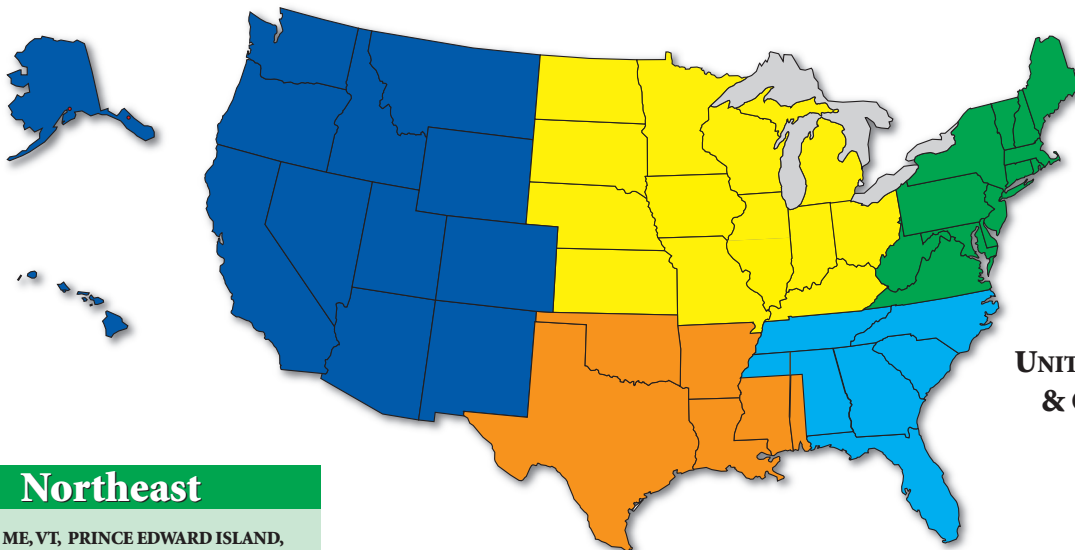

UNITED STATES  
& CANADA

1  
Preface: Sales Representatives

### Northeast

**NH, RI, MA, ME, VT, PRINCE EDWARD ISLAND, NEWFOUNDLAND, NOVA SCOTIA, NEW BRUNSWICK & MANITOBA CANADA**

CGW Associates  
P.O. Box 414, 354 Country Way  
Scituate, MA 02066  
Phone: 781.545.3790, Cell: 617.480.6559  
E-Mail: CGWCO@aol.com,  
**CHARLES W. O'CONNOR**

**DE, MD, VA**  
CGW Associates  
1070 Ulmstead Circle, Arnold, MD 21012  
Phone: 410.757.9630 Fax: 410.757.4365  
E-Mail: KWCGW@aol.com, Cell: 410.808.3048  
**KEVIN WILLIAMS**

**NJ, PA & NY**  
CGW Associates  
115 Park Ave, Shrewsbury, NJ 07702  
Cell: 908.419.3008  
E-Mail: gregdevine1@comcast.net  
**GREG DEVINE**

**ONTARIO & QUEBEC CANADA**  
CGW Associates  
24 Cedarwood Crescent,  
Nobleton, ON, Canada L0G1N0  
Cell: 416.347.5090  
E-Mail: btait@rogers.com  
**BRIAN TAIT**

### Southeast

**NC, SC & Georgia**  
The Gartner Group  
3521 Snead St., Morehead City, NC 28557  
Phone/Cell: 252.675.1764 Fax: 855.280.8627  
E-Mail: trey@thegartnergroup.com  
**TREY BRADLEY**

**TN, AL, MS & FLORIDA PANHANDLE**  
The Gartner Group  
172 Chuniloti Way, Loudon, TN 37774  
Phone: 865.408.7572 Fax: 855.280.8627  
E-Mail: bob@thegartnergroup.com  
**ROBERT TAYLOR**

**NORTH FLORIDA**  
The Gartner Group  
8436 Boxwood Dr., Tampa, FL 33615  
Phone: 813.901.9820, Cell: 813.382.6755  
E-Mail: james@thegartnergroup.com,  
**JAMES HOWE**

**SOUTH FLORIDA**  
The Gartner Group  
1624 SW 4th Ct., Ft. Lauderdale, FL 33312  
Phone: 954.530.7223 Fax: 954.530.7209  
E-Mail: doug@thegartnergroup.com,  
Cell: 954.303.4541  
**DOUG PETERSON**

### South Central

**TX, OK, AR, LA, WESTERN AL, SOUTHERN MS & S.E. AR,**  
MAC-HUGH & Associates, Inc.  
5540A Pepsi Street, Harahan, LA 70123  
Phone: 504.734.9411 Fax: 504.734.5144  
E-Mail: mchugh12@bellsouth.net, Cell: 504.494.4479  
**KYLE McHUGH, BUZZ HUMPHREY, DAVID HILDRETH, GARRETT MCHUGH & KYLE MICHAEL MCHUGH, JR**

### West

**ALBERTA, AK, BRITISH COLUMBIA, ID, MT, OR, WA, WY, UT, & CO**  
The Merifield Company  
1208 SW Camano Drive, Camano Island, WA 98282  
Phone: 360.387.5888 ext. 2, Fax: 360.323.5698  
E-Mail: icross@merifield.com  
**IVAN CROSS**

The Merifield Company  
Mail: P.O. Box 1564, Lake Oswego, OR 97035  
Shipping: 16598 S.W. 72nd Ave., Portland, OR 97224  
Phone: 503.639.5275 Fax: 360.323.5698  
E-Mail: westline1@frontier.com  
**BILL PASCHALL**

The Merifield Company  
P.O. Box 3369, Redmond, WA 98073  
Phone: 360.387.5888, Fax: 360.323.5698  
E-Mail: jawede@msn.com, Cell: 425.985.1620  
**JOHN WEDEBERG**

The Merifield Company  
1961 Main St. Ste 243, Watsonville, CA 95076  
Cell: 707.290.0187, Fax: 360.323.5698  
keith@merifield.com  
**KEITH LAMARR**

**AZ, CA, HI, NM, & NV**  
The Merifield Company  
PO Box 3160, Tustin, CA 92781  
Phone: 714.639.9462, Fax: 360.323.5698  
E-Mail: dnaber@merifield.com, Cell: 714.322.4032  
**DAN NABER**

The Merifield Company  
1961 Main St. Ste 243, Watsonville, CA 95076  
Cell: 831-334-2015, Fax: 360.323.5698  
E-Mail: chris@merifield.com  
**CHRIS MARTORANA**

### Midwest

**NORTHERN IL, KY, IA, ND, SD, NE, MN & WI**  
Inland Marketing Associates, Inc.  
1071 Highland Ct./P.O. Box 414, Plymouth, IN 46563  
Phone: 574.936.6972, Fax: 866.377.9960  
E-Mail: edkuykendall@imarep.com  
**ED KUYKENDALL**

**MI, IN & OH**  
Inland Marketing Associates, Inc.  
675 E. 16th, Holland, MI 49423  
Phone/Cell: 616.392.7720 Fax: 616.392.4601  
impactmarketing@ameritech.net  
**MARK BRUMMEL**

**Southern IL, MO, & KS**  
Inland Marketing Associates, Inc.  
21 Christina Dr., Pevely, MO 63070  
Phone/Cell: 417.631.1860  
kory@imarep.com  
**KORY MITCHELL**

### International

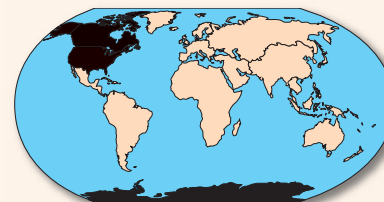

**(EXCLUDING UNITED STATES AND CANADA)**  
E&P Marine Inc.  
2425 N.W. 33rd Ave., Miami, FL 33142  
Phone: 305.634.6110 Fax: 305.634.1191,  
E-Mail: epmarine@navalex.com  
**MIGUEL A. VASALLO, MICHAEL VASALLO, LILLY DIAZ, EDDY HERNANDEZ**

**For Information on all Export & Foreign Regions Contact Perko, Inc. at sales@perko.com**

## Our Modern, Vertically Integrated Manufacturing Facility

Preface: Manufacturing Facility



### Manufacturing Capabilities:

#### Automated Sand Casting

Materials:

- Aluminum - finished castings up to 50 lbs
- Brass - finished castings up to 100 lbs
- Bronze - finished castings up to 100 lbs
- Zinc - finished castings up to 85 lbs

#### Pressure Die Casting

Materials:

- Aluminum - cast weight up to 1 lb
- Brass - cast weight up to 3 lbs
- Bronze - cast weight up to 3 lbs
- Zinc - cast weight up to 5 lbs

#### Investment Casting

Materials:

- Aluminum - cast weight up to 2 lbs
- Brass - cast weight up to 5 lbs
- Bronze - cast weight up to 5 lbs
- Stainless Steel - cast weight up to 4 lbs
- Zinc - cast weight up to 4 lbs

#### Plastic Injection Molding

Materials: (plain or glass filled) up to 3-1/2 lbs

- Acetal, Elastomers, Nylons & Polycarbonate

Size Range:

- Up to 10" x 16" x 15"

#### Mechanical Power Press Metal Forming

- 15 to 60 ton Capacity

#### Chrome Plating

- Semi-automated rack plating
- Copper & nickel sub layers

#### CNC Machining (32 production machines)

- Screw machining up to 1"
- Milling parts up to 40"x 20"x 20"
- Turning parts up to 10"x 10"
- CNC Engraving

#### Metal Finishing

- Tumbling & Vibratory
- Automated and Hand Grinding, Polishing, & Buffing

#### In-house Tool Making for

- CNC Mold Making
- Electrical Discharge Machining (EDM)
- Computer Aided Tool Design
- Investment Molds
- Foundry Patterns
- Stamping Dies





## Our Modern, Vertically Integrated Manufacturing Facility



440, 000 Sq. Ft. Home of PERKO, Inc. Located on 16 Acres in Miami, FL

1  
Preface: Sales Representatives



Aluminum and Bronze Sand Casting



Computer Aided Tool Designing

## Our Modern, Vertically Integrated Manufacturing Facility

Preface: Manufacturing Facility

1

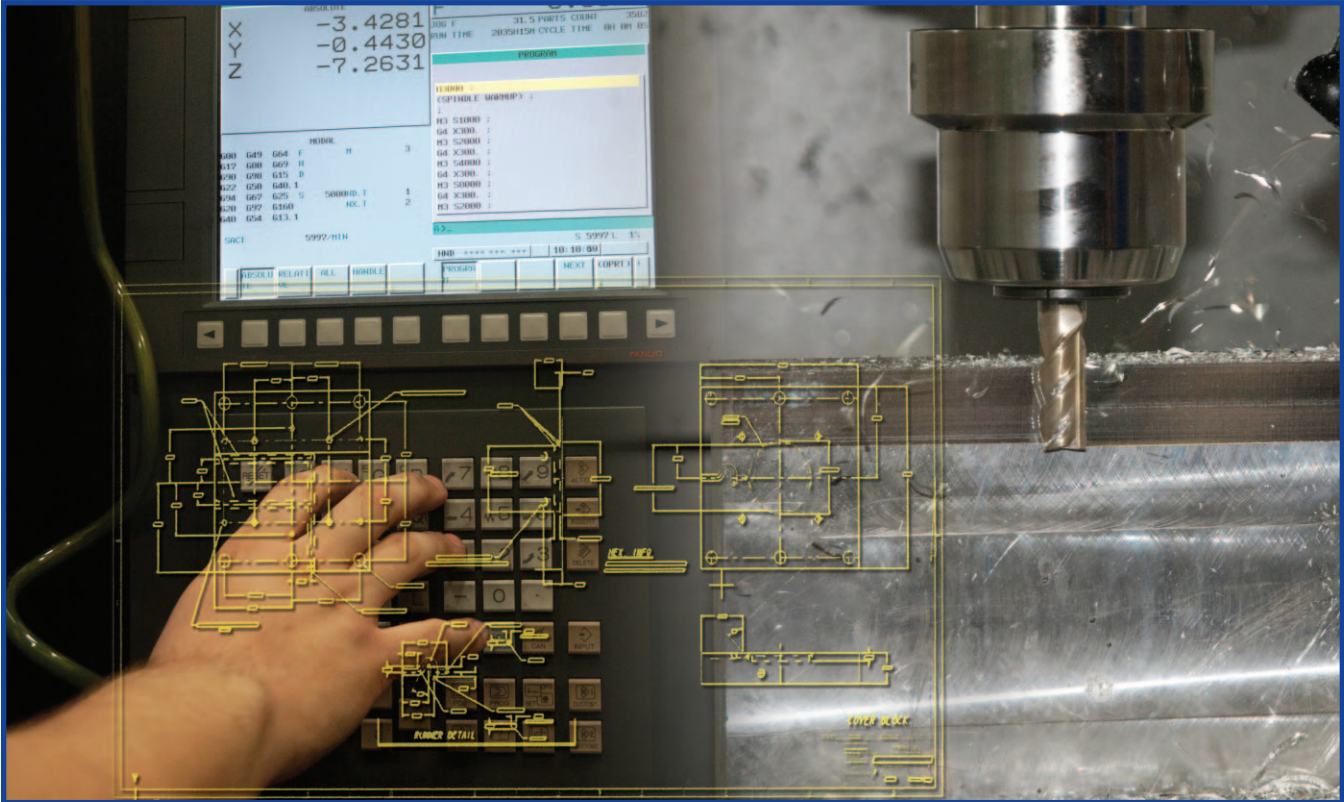

State-of-the-Art Machining



Finished Goods

## Our Modern, Vertically Integrated Manufacturing Facility



**Chrome Plating**



**Multi Operation CNC Drilling and Tapping**



**Lost Wax Investment Casting**

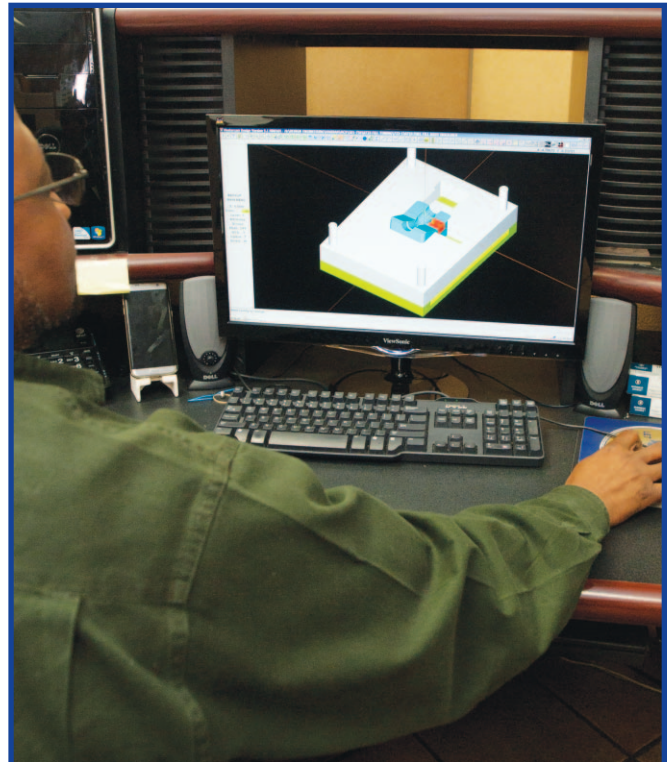

**Computer Aided Product Designing**

## “Look for the Mark”

### How to choose the right navigation lights for your boat

All U.S. registered vessels are subject to either the '72 COLREGS or the U.S. inland rules. Effective 11/1/03, lights must meet one of 3 types of certifications depending on the size of the vessel and the date it was manufactured.

#### LARGE BOATS OVER 20 METERS (65.6 FT.)

The U.S. Coast Guard is accepting lights that have passed the UL tests (A.B.Y.C. A-1104) as meeting the '72 COLREGS and the U.S. Inland Rules for vessels over 20 meters (65.6 ft.). As the first domestic manufacturer to pass UL 1104, PERKO's lights can be installed on vessels over 20 meters (65.6 ft.). PERKO manufactures two classes of lights for the large boat market. The first group of lights is for vessels between 20 meters and 50 meters. The second group includes larger lights and is for vessels over 20 meters (without an upper limit on length).

A brass tag is permanently affixed to the light indicating the type of light, catalog number, voltage and bulb type to install (if applicable) to meet the visibility requirements. It also states that the light is classified by UL or Imanna Labs. in accordance with the '72 COLREGS. This is the only documentation needed by a vessel in this size range for navigation lights to certify light construction compliance with the '72 COLREGS and the U.S. Inland Rules.



#### SMALL BOATS<sup>(1)</sup> UNDER 20 METERS (65.6 FT.)

U.S. requirements for smaller vessels are less strict and they differ depending on when the boat was built.

##### SMALL BOATS BUILT AFTER 11/1/03

The only recognized means of certification of lights for these boats is the USCG approval system. This system uses independent, 3rd party USCG approved labs to conduct some of the tests required for the A-16 certification. On all USCG approved lights, the permanent marking USCG 1nm, USCG 2nm, or USCG 3nm (depending on whether the light is a 1-mile, 2-mile, or 3-mile light) must be visible when the light is installed. Note that certifications may vary with voltage (e.g. USCG approved for 12-volt and A-16 certified for 24-volt).



**USCG 2nm MARKING**

##### SMALL BOATS<sup>(1)</sup> BUILT BEFORE 11/1/03

Lights for these boats must be manufactured in accordance with the American Boat and Yacht Council (A.B.Y.C.) Standard A-16. The primary means of certification recognized in the United States for lights for these boats is through the National Marine Manufacturers' Association (NMMA) certification procedure. USCG approved lights, as described below, are also approved for these applications. All PERKO small boat lights designed for use on boats built before 11/1/03 are certified under this NMMA Certification Procedure. All lights certified under this procedure are required to permanently carry the mark "A-16" visibly displayed when the light is installed.



**A-16 MARKING**

(1) Does not apply to vessels under 7 meters which are not powered



## Horizontal Mount Bi-Color Lights

**LED 2-mile (USCG 2nm) Certified** - Patent #D665,113S  
*Use on Power Driven Vessels Under 20m (65.6 ft.) in Length*

Material: Stainless Steel  
Finish: Polished, Black, or White Powder Coated  
Dimensions: Length: 2-1/2", Width: 2-5/8", Height: 5/8"  
Screw Size: #8  
Voltage: 12V LED  
Wattage: 3.75 watts  
Amperage: <0.25 amps  
Features: Ultra Low Profile, Low Heat, Long Life



**STEALTH II Series**  
Fig. 0615 Stainless

Finish	Retail Pkg.	OEM Bulk Pkg.
Polished SS	0615DP2STS	0615000STS
Black	0615DP2BLK	0615000BLK
White	0615DP2WHT	0615000WHT

Spare gasket kit required for mounting on metallic surfaces (optional for fiberglass surfaces and included in DP package): 0615000GKT



2  
Navigation Lights

**2-mile (USCG 2nm) Certified**  
*Use on Power Driven Vessels Under 20m (65.6 ft.) in Length*

Material: Bronze Top, Polymer Base  
Finish: Chrome, Black, or White  
Dimensions: Length: 3-1/2", Width: 2-1/4", Height: 1-5/8"  
Screw Size: #8  
Contacts: Gold Plated  
Voltage: 12V (Bulb Included)  
Wattage: 10 watts  
Amperage: .80 amps



Fig. 0252 Chrome

Finish	Retail Pkg.	OEM Bulk Pkg.
Chrome	0252MB0DP1	0252MB012V
Black	0252BB0DP1	0252BB012V
White	0252WB0DP1	0252WB012V



Note: Fig. 0252 can also be used as 24-volt A.B.Y.C. A-16 certified lights on boats built prior to 11/1/03. Replace the bulbs provided with Cat. No. 0072DP1CLR 24-volt bulbs. Contact us for 24-volt applications on new construction.

**Fig. 0252:**  
Bulbs: 0071DP0CLR.  
Lens: 0247DP0LNS.  
Black Base with Socket Assembly: 0114000BLK.  
White Base with Socket Assembly: 0114000WHT.

### Spare Parts Information



L.E.D.'s have no user serviceable parts

## Horizontal Mount Bi-Color Lights

### 2-mile (USCG 2nm) Certified

Use on Power Driven Vessels Under 20m (65.6 ft.) in Length

Material: Zinc Alloy Top with Polymer Base,  
 Finish: Chrome Plated or White Powder Coated  
 Dimensions: Length: 3-1/4", Width: 2-1/4", Height: 1-1/2"  
 Screw Size: #6  
 Contacts: Gold Plated  
 Voltage: 12V (Bulb Included)  
 Wattage: 10 watts  
 Amperage: .80 amps



Fig. 0227 Chrome

White

Finish	Retail Pkg.	OEM Bulk Pkg.
Chrome	0227DP0CHR	0227000CHR
White	0227DP0WHT	0227000WHT



### 1-mile (USCG 1nm) Certified - Patent No. 4,500,947

Use on Power Driven Vessels Under 12m (39.4 ft.) in Length

Material: Zinc Alloy Top, Black Polymer Base  
 Finish: Chrome Plated  
 Dimensions: Length: 4", Width: 3-1/8", Height: 1-7/8"  
 Screw Size: #8  
 Contacts: Gold Plated  
 Voltage: 12V (Bulb Included)  
 Wattage: 10 watts  
 Amperage: .80 amps



Fig. 1310

Finish	Retail Pkg.	OEM Bulk Pkg.
Chrome	1310DP0CHR	1310000CHR



### 1-mile (USCG 1nm) Certified

Use on Sail or Power Driven Vessels Under 12m (39.4 ft.) in Length

Material: Brass or Stainless Steel Top, Polymer Base  
 Finish: Chrome Plated or Polished  
 Dimensions: O.D. Base: 2-3/8", Height: 1-5/8"  
 Screw Size: #4  
 Contacts: Gold Plated  
 Voltage: 12V (Bulb Included)  
 Wattage: 10 watts  
 Amperage: .80 amps

Fig. 0972



Finish	Retail Pkg.	OEM Bulk Pkg.
Chrome	0972DP0CHR	0972000CHR
Polished SS	0972DP0STS	0972000STS



Note: The above lights can also be used as 24-volt A.B.Y.C. A-16 certified lights on boats built prior to 11/1/03. Replace the bulbs provided with Cat. No. 0072DP1CLR 24-volt bulbs.

Contact us for 24-volt applications on new construction.

**Fig. 0227:**  
 Bulbs: 0071DP0CLR.  
 Lens: 0227DP0LNS.  
 Black Base w/Socket Assy: 022700099A.  
 White Base w/Socket Assy: 0227W0099A.  
**Fig. 0972:**  
 Bulbs: 0071DP0CLR.  
 Base with Socket Assembly: 0135.  
 Lens, Old Style Open Top: 0296DP0LNS.  
 New Style Closed Top: 0297DP0LNS.

#### Spare Parts Information



Fig. 0227DP0LNS

**Fig. 1310:**  
 Bulbs: 0071DP0CLR.  
 Lens: 0283DPALNS.  
 Base w/Socket Assy: 0136.



Fig. 0283DPALNS



Fig. 0296DP0LNS



Fig. 0297DP0LNS



Fig. 0071 DP0CLR

## Horizontal Mount Bi-Color Lights

**1-mile Certified A-16 for replacement use only** - Patent No. 4,500,947  
*Use on Sail or Power Driven Vessels Under 12m (39.4 ft.) in Length*

Material: Brass or Stainless Steel, Polymer Base  
 Finish: Chrome Plated or Polished  
 Dimensions: Length: 4-1/4", Width: 2-3/8", Height: 1-1/2"  
 Screw Size: #4  
 Contacts: Gold Plated  
 Voltage: 12V (Bulb Included)  
 Wattage: 10 watts  
 Amperage: .80 amps



Fig. 0904

Finish	Retail Pkg.
Chrome	0904DP0CHR
Polished SS	0904DP0STS



**1-mile Certified A-16 for replacement use only**  
*Use on Power Driven Vessels Under 12m (39.4 ft.) in Length*

Material: Zinc Alloy  
 Finish: Chrome Plated  
 Dimensions: Length: 6-3/4", Width: 3-7/8", Height: 3-1/4"  
 Flag Socket: 3/4"  
 Screw Size: #8  
 Voltage: 12V (Bulb Included)  
 Wattage: 10 watts  
 Amperage: .80 amps  
 Features: Flag Staff Socket



Fig. 1218

Finish	Retail Pkg.
Chrome	1218DP0CHR



NOTE: The above light can also be used as 24-volt A.B.Y.C. A-16 certified lights on boats built prior to 11/1/03. Replace the bulbs provided with Cat. No. 0072DP1CLR 24-volt bulbs. Contact us for 24-volt applications on new construction.

### Spare Parts Information

**FIG. 0904:**  
 Bulbs: 0071DP0CLR.  
 Lens Set: 0296DP0LNS.  
 Base with Socket Assembly: 0107.



**FIG. 1218:**  
 Bulbs: 0071DP0CLR.  
 Lens Set: 0259DPALNS.  
 Socket Assembly: 1218DP099A.

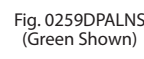

Fig. 0296DP0LNS



Fig. 0297DP0LNS

## Removable Bi-Color Pole Lights

**LED 2-mile (USCG 2nm) Certified** - Patent #D652,161S  
*Use on Power Driven Vessels Under 20m (65.6 ft.) in Length*

Material: Stainless Steel and Polymer Top  
 Finish: Polished with Black Top and Collar  
 Pole Rake: 0°  
 Tube: 3/4" Anodized Aluminum  
 Contacts: Gold Plated  
 Collar: Locking  
 Voltage: 12V LED  
 Wattage: 2.6 watts  
 Amperage: 0.2 amps  
 Base (2-Pin): 1045 or 1047

**STEALTH II Series**



Fig. 1617



Pole Length	Retail Pkg.	OEM Bulk Pkg.
12"	1617DP2BLK	1617002BLK
17-3/8"	1617DP3BLK	1617003BLK

**1-mile (USCG 1nm) Certified** - Patent No. 4,500,947  
*Use on Sail or Power Driven Vessels Under 12m (39.4 ft.) in Length*

Material: Polymer Top  
 Finish: Black Top and Collar  
 Pole Rake: 0°  
 Tube: 3/4" Anodized Aluminum  
 Contacts: Gold Plated  
 Collar: Locking  
 Voltage: 12V (Bulb Included)  
 Wattage: 10 watts  
 Amperage: .80 amps  
 Base (2-Pin): 1045 or 1047



Fig. 1612



**PROP 65 WARNING**  
 (Contains Lead)

Pole Length	Retail Pkg.	OEM Bulk Pkg.
12"	1612DP2BLK	1612002BLK
17-3/8"	1612DP3BLK	1612003BLK

NOTE: Fig. 1612 can also be used as 24-volt A.B.Y.C. A-16 certified lights on boats built prior to 11/1/03. Replace the bulbs provided with Cat. No. 0072DP1CLR 24-volt bulbs. Contact us for 24 volt applications on new construction.

### Compatible Bases (2 Pin)



Bases Sold Separately - See Pages 58 & 59.

### Spare Parts Information

**FIG. 1617:**  
 L.E.D.'s have no user serviceable parts

**FIG. 1612:**  
 Bulbs : 0071DP0CLR.  
 Lens Set: 0283DPALNS.



Fig. 0071DP0CLR



Fig. 0283DPALNS



## Removable Bi-Color Pole Lights with Utility Lights

**2-mile (USCG 2nm) Certified** - Patent No. 4,500,947  
*Use on Power Driven Vessels Under 20m (65.6 ft.) in Length*

Material: Polymer Top  
 Finish: Black Top and Collar  
 Pole Rake: 1421: 0°  
 1422: 5°  
 Contacts: Gold Plated  
 Tube: 3/4" Anodized Aluminum  
 Collar: Locking  
 Voltage: 12V (Bulb Included)  
 Wattage: 10 watts  
 Amperage: .80 amps  
 Base (3-Pin): 1421: 1045 & 1047  
 1422: 1060  
 Features: Deck Illuminating Utility Light



**Fig. 1421**  
0° Rake

**Fig. 1422**  
5° Rake

**Fig. 1421**  
(Shown)

Pole Length	Retail Pkg.	OEM Bulk Pkg.
12"	1421DP2CHR	1421002CHR
17-1/4"	1421DP3CHR	1421003CHR
12"	1422DP2CHR	1422002CHR



**1-mile (USCG 1nm) Certified** - Patent No. 4,500,947  
*Use on Sail or Power Driven Vessels Under 12m (39.4 ft.) in Length*

Material: Zinc Alloy and Polymer Top  
 Finish: Black Top and Collar  
 Pole Rake: 1211: 0°  
 1212: 5°  
 Tube: 3/4" Anodized Aluminum  
 Contacts: Gold Plated  
 Collar: Locking  
 Voltage: 12V (Bulb Included)  
 Wattage: 10 watts  
 Amperage: .80 amps  
 Base (3-Pin): 1211: 1045 & 1047  
 1212: 1060  
 Features: Deck Illuminating Utility Light



**Fig. 1211**  
0° Rake

**Fig. 1212**  
5° Rake

**Fig. 1212**  
(Shown)

Pole Length	Retail Pkg.	OEM Bulk Pkg.
12-1/2"	1211DP2CHR	1211002CHR
12-1/2"	1212DP2CHR	1212002CHR



Removable bi-color lights on pages 14 and 15 are ideal for boats with casting decks on the bow. Unlike conventional bi-color lights that can stand as high as 2" above the deck, removable bi-color lights can be unplugged and stowed while fishing. This leaves only a small, flat topped base. Longer lengths are designed for use with larger trolling motors.

### Compatible Bases (2 Pin)

**Fig. 1045**  
0° Rake



**Fig. 1047**  
0° Rake



**Fig. 1060**  
5° Rake



Bases Sold Separately - See Pages 58 & 59.

### Spare Parts Information

**Figs. 1211, 1212, 1421 & 1422:**

Bulbs: 0071DP0CLR.

Utility Light Bulb: 0064000CLR.

Lens Set Figs.

1211 & 1212 : 0268DP0LNS.

Welded Lens Set Figs. 1421 & 1422

(Black Top) : 0241DP0LNS.



Fig. 0071DP0CLR



Fig. 0268DP0LNS



Fig. 0241

## Horizontal Mount Side Lights

**LED 2-mile (USCG 2nm) Certified** - Patent #D665,113S  
 Use on Power Driven Vessels Under 20m (65.6 ft.) in Length

Material: Stainless Steel  
 Finish: Polished, Black, or White Powder Coated  
 Dimensions: Length: 2-1/2", Width: 2-5/8", Height: 5/8"  
 Screw Size: #8  
 Voltage: 12V LED  
 Wattage: 3.75 watts (each light)  
 Amperage: <0.25 amps (each light)  
 Features: Ultra Low Profile, Low Heat, Long Life



**STEALTH II Series**  
 Fig. 0616 Stainless

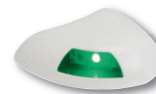

White

Black



Finish	Retail Pkg.*	OEM Bulk Pkg.*
Polished SS	0616DP2STS	0616000STS
Black	0616DP2BLK	0616000BLK
White	0616DP2WHT	0616000WHT

\*Sold in pairs.

Spare gasket kit required for mounting on metallic surfaces (optional for fiberglass surfaces and included in DP package): 0616000GKT

### 2-mile (USCG 2nm) Certified

Use on Power Driven Vessels Under 20m (65.6 ft.) in Length

Material: Bronze Top with Polymer Base or All Polymer  
 Finish: Chrome Plated, Black, or White  
 Dimensions: Length: 3-1/2", Width: 2-1/4", Height: 1-5/8"  
 Screw Size: #8  
 Contacts: Gold Plated  
 Voltage: 12V (Bulb Included)  
 Wattage: 10 watts (each light)  
 Amperage: .80 amps (each light)



**Fig. 0253**  
 Chrome

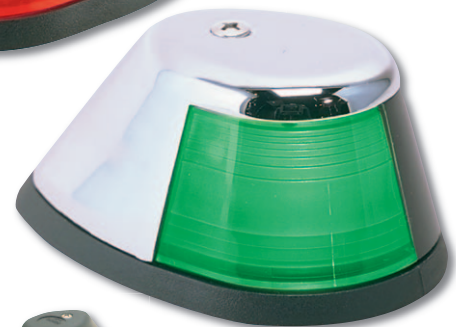

White

Black



Finish	Retail Pkg.*	OEM Bulk Pkg.*
Chrome	0253M00DP1	0253M0012V
Black	0253B00DP1	0253B0012V
White	0253W00DP1	0253W0012V

\*Sold in pairs.



Note: Fig. 0253 can also be used as 24-volt A.B.Y.C. A-16 certified lights on boats built prior to 11/1/03. Replace the bulbs provided with Cat. No. 0072DP1CLR 24-volt bulbs. Contact us for 24-volt applications on new construction.

#### Spare Parts Information

**Fig. 0253:**  
 Green Lens: 0273DPGLNS.  
 Red Lens: 0273DPRLNS.  
 Bulbs: 0071DP0CLR.  
 Base w/Socket Assy: 0114000BLK/WHT.



Fig. 0273



Fig. 0071DP0CLR

**Fig. 0616:**

L.E.D.'s have no user serviceable parts

## Horizontal Mount Side Lights

### 2-mile (USCG 2nm) Certified

Use on Power Driven Vessels Under 20m (65.6 ft.) in Length

Material:	Zinc Alloy Top with Black or White Base,
Finish:	Chrome Plated or White Powder Coated
Dimensions:	Length: 3-1/4", Width: 2-1/4", Height: 1-1/2"
Screw Size:	#6
Contacts:	Gold Plated
Voltage:	12V (Bulb Included)
Wattage:	10 watts (each light)
Amperage:	.80 amps (each light)



Fig. 0228  
Chrome



White

Finish	Retail Pkg.*	OEM Bulk Pkg.*
Chrome	0228DP0CHR	0228000CHR
White	0228DP0WHT	0228000WHT

\*Sold in pairs.



### 1-mile (USCG 1nm) Certified

Use on Sail or Power Driven Vessels Under 12m (39.4 ft.) in Length

Material:	Polymer
Finish:	Black
Dimensions:	Base: 1-1/8" x 3", Height: 1-7/8"
Mount:	Fig. 1601 - Normal "Base-Down" Fig. 1602 - Inverted "Base-Up"
Screw Size:	#8
Voltage:	12V (Bulb Included)
Wattage:	10 watts (each light)
Amperage:	.80 amps (each light)
Use:	Great for Pontoon Boats

Fig. 1601



Fig. 1602

Mount	Retail Pkg.*	OEM Bulk Pkg.*
Base Down	1601DP0BLK	1601000BLK
Base Up	1602DP0BLK	1602000BLK

\*Sold in pairs.



Note: The above lights can also be used as 24-volt A.B.Y.C. A-16 certified lights on boats built prior to 11/1/03. Replace the bulbs provided with Cat. No. 0072DP1CLR 24-volt bulbs. Contact us for 24-volt applications on new construction.

### Spare Parts Information

**Fig. 0228:**

Green Lens: 0228DPGLNS.  
Red Lens: 0228DPRLNS.  
Bulbs (2 per card): 0071DP0CLR.  
Black Base w/Socket Assy: 022700099A.  
White Base w/Socket Assy: 0227W0099A.



Fig. 0228



Fig. 0071DP0CLR

**Figs 1601 & 1602:**

Red Lens Only: 0298DPRLNS,  
Green Lens Only: 0298DPGLNS  
Red Light Only: 1601R00BLK, 1602R00BLK  
Green Light Only: 1601G00BLK, 1602G00BLK  
Bulbs: 0071DP0CLR  
Base w/Socket Assembly: 0139000BLK



Fig. 0298



Fig. 0071DP0CLR

## Horizontal Mount Side Lights

### 1-mile (USCG 1nm) Certified

Use on Sail or Power Driven Vessels Under 12m (39.4 ft.) in Length

Material: Brass or Stainless Steel Top, Polymer Base  
 Finish: Chrome Plated or Polished  
 Dimensions: O.D. Base: 2-3/8", Height: 1-5/8"  
 Screw Size: #4  
 Contacts: Gold Plated  
 Voltage: 12V (Bulb Included)  
 Wattage: 10 watts (each light)  
 Amperage: .80 amps (each light)



Fig. 0963

Finish	Retail Pkg.*	OEM Bulk Pkg.*
Chrome	0963DP0CHR	0963000CHR
Polished SS	0963DP0STS	0963000STS

\*Sold in pairs.



2 Navigation Lights

### 1-mile Certified A-16 for replacement use only

Use on Sail or Power Driven Vessels Under 12m (39.4 ft.) in Length

Material: Brass or Stainless Steel, Polymer Base  
 Finish: Chrome Plated or Polished  
 Dimensions: Length: 4-1/4", Width: 2-3/8", Height: 1-1/2"  
 Screw Size: #4  
 Contacts: Gold Plated  
 Voltage: 12V (Bulb Included)  
 Wattage: 10 watts (each light)  
 Amperage: .80 amps (each light)

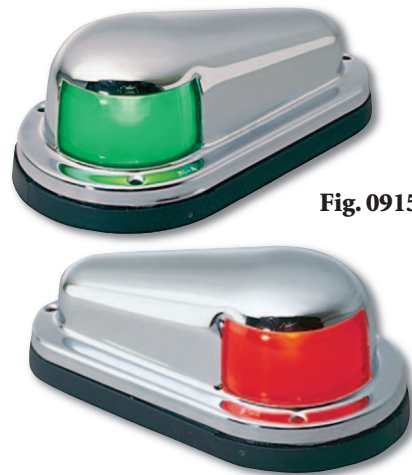

Fig. 0915

Finish	Retail Pkg.*
Chrome	0915DP0CHR
Polished SS	0915DP0STS

\*Sold in pairs.



Note: Fig. 0915 can also be used as 24-volt A.B.Y.C. A-16 certified lights on boats built prior to 11/1/03.

Replace the bulbs provided with Cat. No. 0072DP1CLR 24-volt bulbs. Contact us for 24-volt applications on new construction.

### Spare Parts Information

#### Fig. 0963:

Chrome Brass Green Side Light Only: 0963G00CHR.  
 Chrome Brass Red Side Light Only: 0963R00CHR.  
 Stainless Green Side Light Only: 0963G00STS.  
 Stainless Red Side Light Only: 0963R00STS.  
 Lens Set, Old Style Open Top: 0281DPALNS.  
 Lens Set, New Style Closed Top: 0295DP0LNS.  
 Bulbs: 0071DP0CLR.  
 Base w/Socket Assembly: 0135.

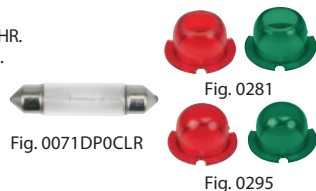

#### Fig. 0915:

Chrome Brass Green Side Light: 0915G00CHR.  
 Chrome Brass Red Side Light: 0915R00CHR.  
 Stainless Green Side Light: 0915G00STS.  
 Stainless Red Side Light: 0915R00STS.  
 Base with Socket Assembly: 0107.  
 Lens Set, Old Style Open Top: 0281DPALNS.  
 Lens Set, New Style Closed Top: 0295DP0LNS.  
 Bulbs: 0071DP0CLR.

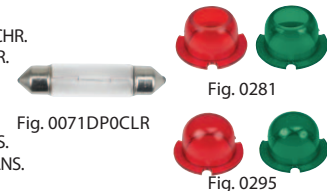

## Vertical Mount Side Lights

### LED 2-mile (USCG 2nm) Certified

Use on Power Driven Vessels Under 20m (65.6 ft.) in Length

Material: Bronze or Polymer  
 Finish: Chrome Plated, White Epoxy Coated or Black  
 Dimensions: Length: 3-1/4", Width: 2", Projection: 1-1/4"  
 Screw Size: #8  
 Voltage: 12V or 24V LED  
 Wattage: 1.2 watts 2.4 watts (each light)  
 Amperage: 0.1 amps 0.1 amps (each light)  
 Features: Low Heat & Long Life



**Fig. 0602  
Chrome**



**Black**



**White**



Finish	Voltage	Retail Pkg.*	OEM Bulk Pkg.*
Chrome	12	0602DP1CHR	0602001CHR
Black	12	0602DP1BLK	0602001BLK
White	12	0602DP1WHT	0602001WHT
Chrome	24	0602DP2CHR	0602002CHR
Black	24	0602DP2BLK	0602002BLK
White	24	0602DP2WHT	0602002WHT

\*Sold in pairs.

### LED 1-mile (USCG 1nm) Certified - Patent #D665,1135

Use on Power Driven Vessels Under 12m (39.4.) in Length

Material: Stainless Steel  
 Finish: Polished, Black, or White Powder Coated  
 Dimensions: Length: 2-1/2", Width: 2-5/8", Projection: 5/8"  
 Screw Size: #8  
 Voltage: 12V LED  
 Wattage: 2.6 watts (each light)  
 Amperage: 0.2 amps (each light)  
 Features: Ultra Low Profile, Low Heat & Long Life



**STEALTH Series  
Fig. 0617 Polished**



**White**



**Black**



Finish	Retail Pkg.*	OEM Bulk Pkg.*
Polished SS	0617DP2STS	0617000STS
Black	0617DP2BLK	0617000BLK
White	0617DP2WHT	0617000WHT

\*Sold in pairs.

Spare gasket kit required for mounting on metallic surfaces (optional for fiberglass surfaces and included in DP package): 0617000GKT

#### Spare Parts Information

L.E.D.'s have no user serviceable parts

## Vertical Mount Side Lights

### LED 2-mile (USCG 2nm) Certified

Use on Power Driven Vessels Under 20m (65.6 ft.) in Length

Material:	Bronze or All Polymer
Finish:	Chrome Plated, Black, or White
Dimensions:	Length: 3-1/2", Width: 2-1/4", Projection: 1-3/8"
Screw Size:	#8
Voltage:	12V LED
Wattage:	4.8 watts (each light)
Amperage:	0.4 amps (each light)
Features:	Low Heat & Long Life



Fig. 0274 Black

Finish	Retail Pkg.*	OEM Bulk Pkg.*
Chrome	0274M00DP1	0274M0012V
Black	0274B00DP1	0274B0012V
White	0274W00DP1	0274W0012V

\*Sold in pairs.

L.E.D.'s have no user serviceable parts



Chrome

White



### 2-mile (USCG 2nm) Certified

Use on Power Driven Vessels Under 20m (65.6 ft.) in Length

Material:	Bronze or All Polymer
Finish:	Chrome Plated, Black, or White
Dimensions:	Length: 3-1/2", Width: 2-1/4", Projection: 1-3/8"
Screw Size:	#8
Contacts:	Gold Plated
Voltage:	12V (Bulb Included)
Wattage:	8 watts (each light)
Amperage:	.70 amps (each light)



Fig. 0254 Chrome

Finish	Retail Pkg.*	OEM Bulk Pkg.*
Chrome	0254M00DP1	0254M0012V
Black	0254B00DP1	0254B0012V
White	0254W00DP1	0254W0012V

\*Sold in pairs.



White

Black



NOTE: Fig. 0254 can also be used as 24-volt A.B.Y.C. A-16 certified lights on boats built prior to 11/1/03. Replace the bulbs provided with 0072DP8CLR. Contact us for 24 volt applications on new construction.

#### Spare Parts Information

Fig. 0254:  
 Green Lens Only: 0277DPGLNS.  
 Red Lens Only: 0277DPRLNS.  
 12 Volt Bulbs: 0071DP8CLR.  
 Base w/Socket Assy: 0254(BLK/WHT)99A.

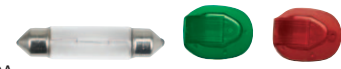

Fig. 0071DP8CLR

Fig. 0277

## Vertical Mount Side Lights

### 2-mile (USCG 2nm) Certified

Use on Power Driven Vessels Under 20m (65.6 ft.) in Length

Material:	Zinc Alloy
Finish:	Chrome Plated
Dimensions:	Length: 3-1/2", Width: 2-1/4", Projection: 1-3/8"
Screw Size:	#8
Contacts:	Gold Plated
Voltage:	12V (Bulb Included)
Wattage:	8 watts (each light)
Amperage:	.70 amps (each light)

<b>Finish</b>	<b>OEM Bulk Pkg.*</b>
Chrome	0264M0012V



Fig. 0264



\*Sold in pairs.

### 1-mile (USCG 1nm) Certified

Use on Sail or Power Driven Vessels Under 12m (39.4 ft.) in Length

Material:	Brass or Stainless Steel Top, Polymer Base
Finish:	Chrome Plated or Polished
Dimensions:	Length: 4-1/4", Width: 2-3/8", Projection: 1-9/16"
Screw Size:	#4
Contacts:	Gold Plated
Voltage:	12V (Bulb Included)
Wattage:	10 watts (each light)
Amperage:	.80 amps (each light)

<b>Finish</b>	<b>Retail Pkg.*</b>	<b>OEM Bulk Pkg.*</b>
Chrome	0955DP0CHR	0955000CHR
Polished SS	0955DP0STS	0955000STS



Fig. 0955



\*Sold in pairs.

### 1-mile Certified A-16 for replacement use only

Use on Power Driven Vessels Under 12m (39.4 ft.) in Length

Material:	Zinc Alloy Top, Vinyl Gasket
Finish:	Chrome Plated
Dimensions:	Length: 5-1/2", Width: 3-1/8", Projection: 1-3/4"
Contacts:	Gold Plated
Screw Size:	#8
Voltage:	12V (Bulb Included)
Wattage:	10 watts (each light)
Amperage:	.80 amps (each light)

<b>Finish</b>	<b>Retail Pkg.*</b>
Chrome Zinc	1264DP0CHR



Fig. 1264



\*Sold in pairs.

NOTE: All the above can also be used as 24-volt A.B.Y.C. A-16 certified lights on boats built prior to 11/1/03. Replace the bulbs provided on Figs. 0955 & 1264 with Cat. No. 0072DP1CLR and Fig. 0264 with 0072DP8CLR 24-volt bulbs. Contact us for 24-volt applications on new construction.

#### Spare Parts Information

**FIG. 0264:**  
Green Lens Only: 0277DPGLNS.  
Red Lens Only: 0277DPRLNS.  
Base w/Socket Assy: 0254BLK99A.  
Bulbs: 0071DP8CLR



Fig. 0277



Fig. 0071DP8CLR

**FIG. 1264:**  
Green Side Light: 1264G00CHR.  
Red Side Light: 1264R00CHR.  
Lens Set: 1264DP0LNS.  
Socket Assembly: 1264DP099A.  
Bulbs: 0071DP0CLR.



Fig. 0071DP0CLR

**FIG. 0955:**  
Chrome Brass Green Side Light: 0955G00CHR.  
Chrome Brass Red Side Light: 0955R00CHR.  
Stainless Green Side Light: 0955G00STS.  
Stainless Red Side Light: 0955R00STS.  
Base with Socket Assembly: 095500099A.  
Lens Set: 0260DP0LNS.  
Bulbs: 0071DP0CLR.



Fig. 0260DP0LNS

## LED European Style Vertical Mount Navigation Light Sets

### 2 Mile/3 Mile LED Certified (USCG 2nm/3nm)

Use on Sail or Power Driven Vessels Under 20m (65.6 ft.) in Length

#### 0170 Series - LED

Material:	Brass or All Polymer with Clear lens	
Finish:	Chrome Plated, Black, or White	
Dimensions:	Height: 3-5/8", Width: 4-1/8", Projection: 2-1/4"	
Screw Size:	#10	
Voltage:	12V or 24 V LED	
<u>Masthead</u>	12V	24V
Wattage:	5.25 watts	5.6 watts
Amperage:	<0.35 amps	<0.20 amps
<u>All Others</u>	12V	24V
Wattage:	4.65 watts	2.52 watts
Amperage:	<0.31 amps	<0.09 amps



**Masthead**



**Side Lights**

**Stern**

**Towing**

Note: LED lenses are clear when light is not illuminated.

	Visibility Arc	Visibility Miles	12 Volt Retail Pkg.	12 Volt Std. Pkg.	24 Volt Retail Pkg.	24 Volt Std. Pkg.
<b>Black Polymer</b>						
Red Side Light	112-1/2°	2	0170BP0DP3	0170BP012L	0170BP0DP4	0170BP024L
Green Side Light	112-1/2°	2	0170BSDDP3	0170BSD12L	0170BSDDP4	0170BSD24L
White Masthead	225°	3	0170BM0DP3	0170BM012L	0170BM0DP4	0170BM024L
White Stern Light	135°	2	0170BSNDP3	0170BSN12L	0170BSNDP4	0170BSN24L
Yellow Towing	135°	2	0170BTWDP3	0170BTW12L	0170BTWDP4	0170BTW24L
<b>Chrome Plated Brass*</b>						
Red Side Light	112-1/2°	2	0170MP0DP3	0170MP012L	0170MP0DP4	0170MP024L
Green Side Light	112-1/2°	2	0170MSDDP3	0170MSD12L	0170MSDDP4	0170MSD24L
White Masthead	225°	3	0170MM0DP3	0170MM012L	0170MM0DP4	0170MM024L
White Stern Light	135°	2	0170MSNDP3	0170MSN12L	0170MSNDP4	0170MSN24L
Yellow Towing	135°	2	0170MTWDP3	0170MTW12L	0170MTWDP4	0170MTW24L
<b>White Polymer</b>						
Red Side Light	112-1/2°	2	0170WP0DP3	0170WP012L	0170WP0DP4	0170WP024L
Green Side Light	112-1/2°	2	0170WSDDP3	0170WSD12L	0170WSDDP4	0170WSD24L
White Masthead	225°	3	0170WM0DP3	0170WM012L	0170WM0DP4	0170WM024L
White Stern Light	135°	2	0170WSNDP3	0170WSN12L	0170WSNDP4	0170WSN24L
Yellow Towing	135°	2	0170WTWDP3	0170WTW12L	0170WTWDP4	0170WTW24L



**Side View**



**Top View**



\* P65 warning applies only to brass body lights on this page.

#### Spare Parts Information

L.E.D.'s have no user serviceable parts





## European Style Vertical Mount Navigation Light Sets

### 2 Mile/3 Mile Certified (USCG 2nm/3nm)

Use on Sail or Power Driven Vessels Under 20m (65.6 ft.) in Length

Material: Brass or All Polymer with Colored Lens  
 Finish: Chrome Plated, Black, or White  
 Dimensions: Height: 3-5/8", Width: 4-1/8", Projection: 2-1/4"  
 Screw Size: #10  
 Voltage: 12V or 24 V (Bulb Included)  
 Masthead 12V      24V  
 Wattage: 10 watts      10 watts  
 Amperage: .83 amps      .42 amps  
 All Others 12V      24V  
 Wattage: 15 watts      18 watts  
 Amperage: .97 amps      .75 amps

### 0170 Series - Incandescent



Masthead



Side Lights

Bi-Color\*

Stern

Towing

	Visibility Arc	Visibility Miles	12 Volt Retail Pkg.	12 Volt Std. Pkg.	24 Volt Retail Pkg.	24 Volt Std. Pkg.
<b>Black Polymer</b>						
Bi-Color Light*	225°	2	0170BB0DP1	-----	0170BB0DP2	-----
Red Side Light	112-1/2°	2	0170BP0DP1	0170BP012V	0170BP0DP2	0170BP024V
Green Side Light	112-1/2°	2	0170BSDDP1	0170BSD12V	0170BSDDP2	0170BSD24V
White Masthead Light	225°	3	0170BM0DP1	0170BM012V	0170BM0DP2	0170BM024V
White Stern Light	135°	2	0170BSNDP1	0170BSN12V	0170BSNDP2	0170BSN24V
Yellow Towing Light	135°	2	0170BTWDP1	0170BTW12V	0170BTWDP2	0170BTW24V
<b>Chrome Plated Brass</b>						
Bi-Color Light*	225°	2	0170MB0DP1	-----	0170MB0DP2	-----
Red Side Light	112-1/2°	2	0170MP0DP1	0170MP012V	0170MP0DP2	0170MP024V
Green Side Light	112-1/2°	2	0170MSDDP1	0170MSD12V	0170MSDDP2	0170MSD24V
White Masthead Light	225°	3	0170MM0DP1	0170MM012V	0170MM0DP2	0170MM024V
White Stern Light	135°	2	0170MSNDP1	0170MSN12V	0170MSNDP2	0170MSN24V
Yellow Towing Light	135°	2	0170MTWDP1	0170MTW12V	0170MTWDP2	0170MTW24V
<b>White Polymer</b>						
Bi-Color Light*	225°	2	0170WB0DP1	-----	0170WB0DP2	-----
Red Side Light	112-1/2°	2	0170WP0DP1	0170WP012V	0170WP0DP2	0170WP024V
Green Side Light	112-1/2°	2	0170WSDDP1	0170WSD12V	0170WSDDP2	0170WSD24V
White Masthead Light	225°	3	0170WM0DP1	0170WM012V	0170WM0DP2	0170WM024V
White Stern Light	135°	2	0170WSNDP1	0170WSN12V	0170WSNDP2	0170WSN24V
Yellow Towing Light	135°	2	0170WTWDP1	0170WTW12V	0170WTWDP2	0170WTW24V

\* Certified for A-16 Replacement Use Only on Vessels Built Prior to 11/1/03.



### Spare Parts Information

Bulbs (2 per card) for 0170BSN, MSN & WSN (12 Volt): 0069DP0CLR.  
Bulbs (2 per card) for All Other 12 Volt 0170's: 0070DP1CLR.

Bulbs (2 per card) for 0170BSN, MSN & WSN (24 Volt): 0067DP1CLR.  
Bulbs (2 per card) for All Other 24 Volt 0170's: 0067DP2CLR.



For Lens and Shield Assembly, Replace the Last Three Digits of the Catalog Number with the Letters "LNS" (e.g., 0170BB0LNS, for a Black Shield and Bi-Color Lens).

## Navigation Light Sets

### 2 Mile/3 Mile Certified (USCG 2nm/3nm)

Use on Power Driven Vessels Under 20m (65.6 ft.) in Length

Material: Polymer  
 Finish: Black  
 Dimensions: **Fig 0109:**  
 H: 5-1/4", W: 5-1/2", Proj: 3-7/8"  
 Lens Height: 4-1/4"  
**Figs 0110 & 0111:**  
 H: 5-1/4", W: 4-3/4", Proj: 3-7/8"  
 Screw Size: #10  
 Voltage: 12 or 24V (Bulb Not Included)  
           12V      24V  
 Wattage: 15 watts    18 watts  
 Amperage: .97 amps   .75 amps



**Fig. 0110 Masthead**



Navigation Lights

2

Std. Pkg.	Description	Visibility Arc	Visibility Miles
0109R00BLK	Red Side Light	112-1/2°	2nm
0109G00BLK	Green Side Light	112-1/2°	2nm
0110000BLK	White Masthead Light	225°	3nm
0111000BLK	White Stern Light	135°	2nm
0111M00BLK	Yellow Towing Light	135°	2nm



**Fig. 0109 Side Lights**



**Fig. 0111 Stern & Towing**

### 2 Mile (USCG 2nm) Certified

Use on Power Driven Vessels Under 20m (65.6 ft.) in Length

Material: Polymer  
 Finish: Black Base, White, Red, or Green Lens  
 Dimensions: Height: 6", O.D. Base: 3-1/8", Lens Height: 5"  
 Tapped Pipe Size: 1/2"  
 Screw Size: #10  
 Voltage: 12, 24 or 32 Volt (Bulb Not Included)  
           12V      24V  
 Wattage: 15 watts    18 watts  
 Amperage: .97 amps   .75 amps



**Fig. 0108 White**



**Pipe Mount Base**



**Green**

**Red**

Std. Pkg.	Description	Visibility Arc	Visibility Miles
0108000BLK	White All-Round Light*	360°	2nm
0108R00BLK	Red All-Round Light	360°	2nm
0108G00BLK	Green All-Round Light	360°	2nm

\*This Light is Supplied with a Gray Tinted Globe.

### Spare Parts Information

**Replacement Lenses:**

112-1/2° Fig. No. 0259H02, Specify RED or GRN.  
 135° Fig. No. 0269H02, Specify YLW or WHT.  
 225° Fig. No. 0256H02WHT.  
 360° Fig. No. 0106000, Specify RED, GRN, GRY or WHT.

**Lens Dimensions**

Fig. 0259: 4-1/4" x 4"  
 Fig. 0269: 4-1/4" x 4"  
 Fig. 0256: 4-1/4" X 4-1/4"  
 Fig. 0106: 5" X 3-5/8" O.D.

**Required Bulbs:**

For 12 Volt: 0070DP1CLR.  
 For 24 Volt: 0067DP2CLR.  
 For 32 Volt: 0070DP2CLR.  
 Base and Gasket for Fig. No. 0108: 0222DP0BLK.



## LED Navigation Light Sets

### Base Mount 2 Mile/3 Mile LED Certified (USCG 2nm/3nm)

Use on Sail or Power Driven Vessels Under 20m (65.6 ft.) in Length

Material: Polymer  
 Finish: Black or White  
 Dimensions: Height: 3-13/16", O.D. Base: 3-5/16",  
 Screw Size: #10  
 Voltage: 12/24 VDC LED  
 Wattage: 2.6 watts  
 Amperage: 0.2 amps



Fig. 0210 Base Mount Green Side light

Base Mount	Visibility Arc	Black Retail Pkg.	White Std. Pkg.	Visibility Miles
Red Side Light	112-1/2°	0210PB0DP1	0210PB0W01	2
Green Side Light	112-1/2°	0210SDBDP1	0210SDBW01	2
White Masthead Light	225°	0210MB0DP1	0210MB0W01	3
White Stern Light	135°	0210SNBDP1	0210SNBW01	2
Yellow Towing Light	135°	0210TWBDP1	0210TWBW01	2
White All-Round Light	360°	0210SWBDP1	0210SWBW01	2
Red All-Round Light	360°	0210SRBDP1	0210SRBW01	2
Green All-Round Light	360°	0210SGBDP1	0210SGBW01	2



For Pipe Mounting Bracket options see Figs. 0222 & 0224 on page 27

2

Navigation Lights

### Top Mount 2 Mile/3 Mile LED Certified (USCG 2nm/3nm)

Use on Sail or Power Driven Vessels Under 20m (65.6 ft.) in Length

Material: Black or White Polymer  
 Dimensions: Top Mt: Height: 4-13/16", O.D.: 3-5/16", Projection: 3-5/16"  
 Screw Size: #8  
 Voltage: 12/24 VDC LED  
 Wattage: 2.6 watts  
 Amperage: 0.2 amps  
 Features: Stainless Steel Mounting Bracket Included



Fig. 0210 Top Mount Masthead

Top Mount	Visibility Arc	Black Retail Pkg.	White Std. Pkg.	Visibility Miles
Red Side Light	112-1/2°	0210PT0DP1	0210PT0W01	2
Green Side Light	112-1/2°	0210SDTDP1	0210SDTW01	2
White Masthead Light	225°	0210MT0DP1	0210MT0W01	3
White Stern Light	135°	0210SNTDP1	0210SNTW01	2
Yellow Towing Light	135°	0210TWTDP1	0210TWTW01	2



#### Spare Parts Information

Note: L.E.D. lights have no user serviceable parts

## Navigation Light Sets

### Base Mount 2 Mile/3 Mile Certified (USCG 2nm/3nm)

Use on Sail or Power Driven Vessels Under 20m (65.6 ft.) in Length

Material: Polymer  
 Finish: Black or White  
 Dimensions: Height: 4-7/8", O.D. Base: 3-5/16",  
 Screw Size: #10  
 Voltage: 12 or 24V (Bulb Included)  
 Wattage: Bulb: 25 watt or 10 watt  
 Amperage: 25 watt                      10 watts  
                   12V: 2.08 amps            12V: .83 amps  
                   24V: 1.04 amps                24V: .42 amps

**Fig. 0200**  
**Base Mount**  
**Green**  
**Side Light**



**PROP 65**  
**WARNING**  
 (Contains Lead & DINP)



**Red**  
**Side Light**

**Stern**

**Green**  
**All-Round**

Base Mount	Visibility Arc	Black Retail Pkg.	White* Std. Pkg.	Visibility Miles	Replacement Bulb
Bi-Color Light	225°	0200BB0DP1	0200BB0W01	2	037512V25W
Red Side Light	112-1/2°	0200PB0DP1	0200PB0W01	2	037512V25W
Green Side Light	112-1/2°	0200SDBDP1	0200SDBW01	2	037512V25W
White Masthead Light	225°	0200MB0DP1	0200MB0W01	3	037512V25W
White Stern Light	135°	0200SNBDP1	0200SNBW01	2	037512V10W
Yellow Towing Light	135°	0200TWBDP1	0200TWW01	2	037512V10W
White All-Round Light	360°	0200SWBDP1	0200SWBW01	2	037512V10W
Red All-Round Light	360°	0200SRBDP1	0200SRBW01	2	037512V25W
Green All-Round Light	360°	0200SGBDP1	0200SGBW01	2	037512V25W
Tri-Color Light**	360°	0200TB0DP1	0200TB0W01	2	037512V25W

\* 12 Volt Only

\*\* Use For Vessels Under Sale Alone

For Pipe Mounting Bracket options, see Figs. 0222 & 0224 on page 27.

### Top Mount 2 Mile/3 Mile Certified (USCG 2nm/3nm)

Use on Power Driven Vessels Under 20m (65.6 ft.) in Length

Material: Black or White Polymer  
 Stainless Steel Mounting Bracket Included  
 Dimensions: Height: 4-13/16", O.D.: 3-5/16", Projection: 3-5/16"  
 Screw Size: #10  
 Voltage: 12 or 24V (Bulb Included)  
 Wattage: Bulb: 25 watt or 10 watt  
 Amperage: 25 watt                      10 watts  
                   12V: 2.08 amps            12V: .83 amps  
                   24V: 1.04 amps                24V: .42 amps

**Fig. 0200**  
**Top Mount**  
**Masthead**



**PROP 65**  
**WARNING**  
 (Contains Lead & DINP)



**Red**  
**Side Light**

**Stern**

**Towing**

Top Mount	Visibility Arc	Black Retail Pkg.	White* Std. Pkg.	Visibility Miles	Replacement Bulb
Bi-Color Light	225°	0200BT0DP1	0200BT0W01	2	037512V25W
Red Side Light	112-1/2°	0200PT0DP1	0200PT0W01	2	037512V25W
Green Side Light	112-1/2°	0200SDTDP1	0200SDTW01	2	037512V25W
White Masthead Light	225°	0200MT0DP1	0200MT0W01	3	037512V25W
White Stern Light	135°	0200SNTDP1	0200SNTW01	2	037512V10W
Yellow Towing Light	135°	0200TWTDP1	0200TWTW01	2	037512V10W

\* 12 Volt Only

### Ordering Info - For 24V (Black Only) on pages 26 and 27

Note: For 24V Lights, Replace the "DP1" with "DP2". For the Replacement Bulb, Replace the "12V" with "24V" (e.g., 037524V25W).

For 32V Lights: Contact the Factory.



## Navigation Light Sets

### Double Stack Base Mount 2 Mile/3 Mile Certified (USCG 2nm/3nm)

Use on Sail or Power Driven Vessels Under 20m (65.6 ft.) in Length

Material: Polymer  
 Finish: Black or White  
 Dimensions: Height: 8-5/8", O.D.: 3-5/16"  
 Screw Size: #10  
 Voltage: 12 or 24V (Bulb Included)  
 Wattage: Upper: 25 watts  
 Lower: 10 watts  
 Amperage: 25 watt                      10 watts  
                   12V: 2.08 amps            12V: .83 amps  
                   24V: 1.04 amps            24V: .42 amps

Fig. 0200TAB\*\*



Double Stack Base Mount	Visibility Arc	Black Retail Pkg.	White* Std. Pkg.	Visibility Miles	Replacement Bulb
Tri-Color/White All-Round Light**	360°	0200TABDP1	0200TABW01	2/2	037512V25W/10W
Masthead/White All-Round Light	360°	0200MABDP1	0200MABW01	3/2	037512V25W/10W
Green/Red All-Round Light	360°	0200GRBDP1	0200GRBW01	2/2	037512V25W/25W

\* 12 Volt Only

\*\* For Use on Vessels Under Sail Alone.

For Pipe Mounting Bracket options, see Figs. 0222 & 0224 below.



### Halyard Mount 2 Mile/3 Mile Certified (USCG 2nm/3nm)

Use on Sail or Power Driven Vessels Under 20m (65.6 ft.) in Length

Material: Black or White Polymer  
 Stainless Steel Mounting Hardware  
 Dimensions: Height: 7-1/8", O.D.: 3-5/16"  
 Screw Size: No mounting screws required  
 Voltage: 12 or 24V (Bulb Included)  
 Wattage: 25 watt or 10 watt  
 Amperage: 25 watt                      10 watts  
                   12V: 2.08 amps            12V: .83 amps  
                   24V: 1.04 amps            24V: .42 amps

Fig. 0200SRH



Halyard Mount	Visibility Arc	Black Retail Pkg.	White* Std. Pkg.	Visibility Miles	Replacement Bulb
White All-Round Light	360°	0200SWHDP1	0200SWHW01	2	037512V10W
Red All-Round Light	360°	0200SRHDP1	0200SRHW01	2	037512V25W
Green All-Round Light	360°	0200SGHDP1	0200SGHW01	2	037512V25W

\* 12 Volt Only



### Pipe Mounting Brackets For Use on All 0200/0210 Series Base Mount Lights

Material: Black or White Polymer  
 Includes Screws and Soft Mounting Gasket for Mounting Bracket to Light  
 Dimensions: Tapped Pipe Size: 1/2",  
 O.D. Overall: 3-5/16"

Mount	Black Retail Pkg.	White Retail Pkg.
Flat	0222DP0BLK	0222DP0WHT
Cone	0224DP0BLK	0224DP0WHT



Fig. 0222 - BLK



Fig. 0224 - WHT



Fig. 0224 Shown Mounted

### Spare Parts Information for pages 26 and 27

Lens assembly part numbers are determined by replacing the last three digits of the Catalog Number with the letters "LNS" (example: 0200BT0LNS, for a Bi-Color Top Mount Lens Assembly). Replacement Bulb Sockets: (single and lower for double) Cat. No. 0093, (upper for double), Cat No. 0095.

## LED "Flex Mount" Navigation Lights

Double Mount Light Shown



Fig. 1490 All-Round Light

### The "Flex Mount" Navigation Light System

Perko's "Flex Mount" system allows the same light to be used for both single and double mount applications. A powder coated aluminum, high strength support structure holds 2 individual lights and mounts to the deck. Then, should either of the two lights be damaged, the damaged light can be easily removed from the support structure and replaced leaving the undamaged light in place significantly reducing the cost of the repair.



Fig. 1381 Aluminum Mounting Bracket



Double Mount Light Components

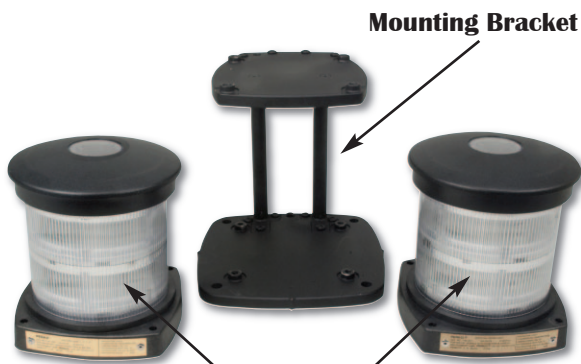

Mounting Bracket

Two Replaceable Single Mount Lights



Individual lights can be replaced if damaged while in service.

See Perko's Website:  
for the L.E.D. "Flex Mount" Double Stack Light Sets  
Figs. 1077-1080 Series (2nm/5nm) and  
the NEW Figs. 1487-1490 Series (3nm/6nm) versions  
<http://www.perko.com/flexmount>

## LED "Flex Mount" Navigation Lights

### 2 Mile/5 Mile LED Certified (USCG 2nm/5nm)

Use on Power Driven Vessels 20m (65.6 ft.) to 50 m (164.0 ft.) in Length

- Material: Black or White Polymer  
Pre-Wired with 3 Feet of 18/2-SO Cable
- Dimensions: Height: 6", Base: 5-3/8" x 5-3/8"
- Screw Size: 1/4"
- Voltage: Operates on 12/24 VDC LED or 120/240 VAC LED
- Features: Translucent color specific insert on top of light  
Sealed Cap



**Fig. 1378**  
Masthead Light



White



**Fig. 1377**  
Red & Green Side Lights

**Fig. 1379**  
Stern Light

**Fig. 1379**  
Towing Light

**Fig. 1380**  
All-Round Light

2

Navigation Lights

Description	Visibility Arc	Visibility Miles	12/24 VDC Black Std. Pkg.	12/24 VDC White Std. Pkg.	Watts	Amps
Red Side Light	112-1/2°	2	1377R01BLK	1377R01WHT	2.5	0.2
Green Side Light	112-1/2°	2	1377G01BLK	1377G01WHT	2.5	0.2
White Masthead Light	225°	5	1378001BLK	1378001WHT	4.7	0.4
White Stern Light	135°	2	1379001BLK	1379001WHT	2.5	0.2
Yellow Towing Light	135°	2	1379M01BLK	1379M01WHT	2.5	0.2
White All-Round Light	360°	2	1380001BLK	1380001WHT	2.5	0.2
White All-Round Light*	360°	5	1380H01BLK	1380H01WHT	2.5	0.2
Red All-Round Light	360°	2	1380R01BLK	1380R01WHT	2.5	0.2
Green All-Round Light	360°	2	1380G01BLK	1380G01WHT	2.5	0.2
Yellow All-Round Light	360°	2	1380M01BLK	1380M01WHT	2.5	0.2

Description	Visibility Arc	Visibility Miles	120/240 VAC Black Std. Pkg.	120/240 VAC White Std. Pkg.	Watts	Amps
Red Side Light	112-1/2°	2	1377R00BLK	1377R00WHT	3.7	0.03
Green Side Light	112-1/2°	2	1377G00BLK	1377G00WHT	3.7	0.03
White Masthead Light	225°	5	1378000BLK	1378000WHT	7.2	0.06
White Stern Light	135°	2	1379000BLK	1379000WHT	3.7	0.03
Yellow Towing Light	135°	2	1379M00BLK	1379M00WHT	3.7	0.03
White All-Round Light	360°	2	1380000BLK	1380000WHT	3.7	0.03
White All-Round Light*	360°	5	1380H00BLK	1380H00WHT	3.7	0.03
Red All-Round Light	360°	2	1380R00BLK	1380R00WHT	3.7	0.03
Green All-Round Light	360°	2	1380G00BLK	1380G00WHT	3.7	0.03
Yellow All-Round Light	360°	2	1380M00BLK	1380M00WHT	3.7	0.03

Special lights to meet local requirements are available upon request

\*For Great Lakes use

Note: L.E.D.'s have no user serviceable parts



Marine Navigation Lights Certified to the USCG and '72 COLREGS By Imanna Labs in accordance with A.B.Y.C. A-1104 (UL 1104).

## Navigation Light Sets

### 2 Mile/5 Mile Certified (USCG 2nm/5nm)

Use on Power Driven Vessels 20m (65.6 ft.) to 50 m (164.0 ft.) in Length

Material: Black or White Polymer  
Pre-Wired with 3 Feet of 16/3-SO Cable

Dimensions: Height: 7-1/2", Base: 5-9/32" x 5-9/32"

Screw Size: 1/4"

Voltage: 12, 24 or 120V (Bulb Not Included)

	<u>12V</u>	<u>24V</u>	<u>120V</u>
Wattage:	30 watts	30 watts	30 watts
Amperage:	2.5 amps	1.25 amps	.25 amps

**Features:** Watertight Access Cap for Rebulbing and Cleaning



**Fig. 1128**  
Masthead Light



**Fig. 1127**  
Red & Green Side Lights



**Fig. 1129**  
Stern Light



**Fig. 1129**  
Towing Light



**Fig. 1130**  
All-Round Lights

Description	Visibility Arc	Visibility Miles	Black Std. Pkg.	White Std. Pkg.
Red Side Light	112-1/2°	2	1127RA0BLK	1127RA0WHT
Green Side Light	112-1/2°	2	1127GA0BLK	1127GA0WHT
White Masthead Light	225°	5	1128A00BLK	1128A00WHT
White Stern Light*	135°	2	1129A00BLK	1129A00WHT
Yellow Towing Light	135°	2	1129MA0BLK	1129MA0WHT
White All-Round Light*	360°	2	1130A00BLK	1130A00WHT
White All-Round Light**	360°	5	1130HA0BLK	1130HA0WHT
Red All-Round Light	360°	2	1130RA0BLK	1130RA0WHT
Green All-Round Light	360°	2	1130GA0BLK	1130GA0WHT
Yellow All-Round Light	360°	2	1130MA0BLK	1130MA0WHT

Special lights to meet local requirements are available upon request.

\*These lights are supplied with a Gray Tinted Lens

\*\*For Great Lakes use



### Spare Parts Information

**IMPORTANT BULB DATA**  
To comply with UL Standard A-1104 (A.B.Y.C.), the lights listed on this page must use a PERKO Cat. No. 0374 bulb.

**Lens Assemblies:**  
Red: 0249000RED  
Green: 0249000GRN  
White: 0249000CLR  
Gray: 0249000GRY  
Yellow: 0249000YLW



Fig. 0249

**Required Bulbs:**  
12 Volt: 0374001CLR  
24 Volt: 0374002CLR  
120 Volt: 0374004CLR



Fig. 0374

**Other Parts:**  
O-Ring for Cap: 1119  
Double Contact Socket: 0134  
Access Cap, O-Ring and Retainer:  
Blk:1105000BLK or Wht:1105000WHT



## Masthead Lights

### 3-mile (USCG 3nm) Certified

Use on Sail or Power Driven Vessels Under 20m (65.6 ft.) in Length

Material:	All Polymer	
Finish:	Black	
Dimensions:	Height: 7", Width: 4-1/8", Projection: 4-3/4"	
Screw Size:	#10	
Voltage:	12V LED or Incandescent (Bulb Included)	
<u>Masthead Light</u>	<u>Incandescent</u>	<u>LED</u>
Watts:	10 watts	5.6 watts
Amperage:	.83 amps	0.4 amps
<u>Spreader Light</u>		
Watts:	20 watt	2.2 watts
Amperage:	1.56 amps	0.18 amps
Features:	Bottom light works as a Combination Spreader and Deck Illumination Light	

### Combination Masthead/Deck Spreader Light



**Fig. 0170BMD LED**

Light Type	Retail Pkg.	Std. Pkg.
Incandescent	0170BMDDP1	0170BMD12V
LED	-----	0170BMD12L



**LED Spreader Light**

**Fig. 0170BMD Incandescent**



2

Navigation Lights

### 2-mile Certified A-16 for replacement use only

Use on Sail or Power Driven Vessels Under 12m (39.4 ft.) in Length

Material:	Brass or Stainless Steel Top, Polymer Base
Finish:	Chrome Plated or Polished
Dimensions:	O.D. Base: 2-3/8", Height: 1-5/8"
Screw Size:	#4
Contacts:	Gold Plated
Voltage:	12V (Bulb Included)
Wattage:	10 watts
Amperage:	.80 amps



**Fig. 0964 Masthead**

Finish	Retail Pkg.
Chrome Plated	0964DP0CHR
Polished SS	0964DP0STS



Fig. 0964 can also be used as 24-volt A.B.Y.C. A-16 certified lights on boats built prior to 11/1/03. Replace the bulbs provided with Cat. No. 0072DP1CLR 24-volt bulbs. Contact us for 12 or 24 volt applications on new construction.

#### Spare Parts Information

**Fig. 0170 BMD:**  
 Masthead Bulb: 0070DP1CLR.  
 12V Halogen Bulb for Deck Spreader Light: 006812V20W.  
 L.E.D.'s have no user serviceable parts



Fig. 0070DP1CLR

**Fig. 0964:**  
 Lens (Open Top): 0281DPAWHT.  
 Lens (Closed Top): 0295DPOWHT.  
 Bulbs: 0071DP0CLR.  
 Base with Socket Assembly: 0135.



Fig. 0071DP0CLR

Fig. 0295

Fig. 0281

## Masthead and Stern Lights

### 3-mile (USCG 3nm) Certified

Use on Sail or Power Driven Vessels Under 20m (65.6 ft.) in Length

Material: Zinc Alloy Top and Polymer Base  
 Finish: Chrome Plated with Black Base  
 Dimensions: Height: 3-1/4", Width: 1-1/2", Projection: 1-3/8"  
 Screw Size: #4  
 Contacts: Gold Plated  
 Voltage: 12V (Bulb Included)  
 Wattage: 10 watts  
 Amperage: .80 amps

Light Type	Retail Pkg.	OEM Bulk Pkg.
Masthead	1331DPOCHR	1331000CHR



**Fig. 1331**  
Vertical Mt.  
Masthead



### 2-mile Certified A-16 for replacement use only

Use on Sail or Power Driven Vessels Under 20m (65.6 ft.) in Length

Material: Zinc Alloy Top and Polymer Base  
 Finish: Chrome Plated with Black Base  
 Dimensions: Height: 3-1/4", Width: 1-1/2", Projection: 1-3/8"  
 Screw Size: #4  
 Contacts: Gold Plated  
 Voltage: 12V (Bulb Included)  
 Wattage: 10 watts  
 Amperage: .80 amps

Light Type	Retail Pkg.
Stern	1332DPOCHR



**Fig. 1332**  
Vertical Mt.  
Stern



### 2-mile Certified A-16 for replacement use only

Use on Sail or Power Driven Vessels Under 20m (65.6 ft.) in Length

Material: Brass or Stainless Steel Top, Black Base  
 Finish: Chrome Plated or Polished  
 Dimensions: O.D. Base: 2-3/8", Projection: 1-3/8"  
 Screw Size: #4  
 Contacts: Gold Plated  
 Voltage: 12V (Bulb Included)  
 Wattage: 10 watts  
 Amperage: .80 amps

Finish	Retail Pkg.
Chrome	0945DPOCHR
Polished SS	0945DP0STS



**Fig. 0945**  
Vertical Mt.  
Stern



NOTE: Figs. 0945 & 1332 can also be used as a 24-volt A.B.Y.C. A-16 certified light on boats built prior to 11/1/03. Replace the bulb provided with Cat. No. 0072DP1CLR 24-volt bulbs. Contact us for 24 volt applications on new construction.

#### Spare Parts Information

**Figs. 1331 & 1332:**  
 Bulbs: 0071DPOCLR.  
 Lenses: 0278DP0WHT.  
**Fig. 0945:**  
 Bulbs: 0071DPOCLR.  
 Lens: 0074DP0WHT  
 Base & Socket Assy: 0945DP099A



Fig. 0071DPOCLR



Fig. 0278

## Stern Lights

### 2-mile (USCG 2nm) Certified

Use on Sail or Power Driven Vessels Under 20m (65.6 ft.) in Length

Material:	Brass or Stainless Steel with Polymer Base
Finish:	Chrome Plated or Polished
Dimensions:	O.D.: 3", Depth: 1"
Screw Size:	#8
Voltage:	12V (Bulb Included)
Wattage:	10 watts
Amperage:	.74 amps
Features:	Flush Mount

Finish	Retail Pkg.	OEM Bulk Pkg.
Chrome	0946DP112V	094600112V
Polished SS	0946DP1STS	0946001STS



**Fig. 0946**  
Vertical Mt. Stern



Coordinating cockpit lights available: See Fig. 1146 on page 64.

### 2-mile (USCG 2nm) Certified

Use on Sail or Power Driven Vessels Under 20m (65.6 ft.) in Length

Material:	Brass or Stainless Steel Top, Black Base
Finish:	Chrome Plated or Polished
Dimensions:	Height: 3-3/8", Width: 5-3/16", Depth: 1-1/2"
Screw Size:	#8
Voltage:	12V (Bulb Included)
Wattage:	10 watts
Amperage:	.74 amps
Features:	Flush Mount

Finish	Retail Pkg.
Chrome	0939DP112V
Polished SS	0939DP1STS



**Fig. 0939**  
Vertical Mt. Stern



### 2-mile (USCG 2nm) Certified

Use on Sail or Power Driven Vessels Under 20m (65.6 ft.) in Length

Material:	Brass or Stainless Steel Top and Polymer Base
Finish:	Chrome Plated or Polished
Dimensions:	O.D. Base: 2-3/8", Height: 1-5/8"
Screw Size:	#4
Contacts:	Gold Plated
Voltage:	12V (Bulb Included)
Wattage:	10 watts
Amperage:	.80 amps

Finish	Retail Pkg.	OEM Bulk Pkg.
Chrome	0965DP0CHR	0965000CHR
Polished SS	0965DP0STS	0965000STS



**Fig. 0965**  
Horizontal Mt. Stern



Fig. 0965 can also be used as 24-volt A.B.Y.C. A-16 certified lights on boats built prior to 11/1/03. Replace the bulb provided with Cat. No. 0072DP1CLR 24-volt bulbs. Contact us for 24 volt applications on new construction.

### Spare Parts Information

**Fig. 0946:**

Bulbs: 0070DP0CLR.  
Socket Assembly: 0946DP199B.  
Lens with O-Ring: 0946DP099A.  
Mounting Flange: 094600099C.



Fig. 0070

**Fig. 0939:**

Bulbs: 0070DP0CLR.  
Socket Assy: 0939DP199A.  
Lens with O-Ring: 0284DP0CLR.  
Mount w/Flange: 093900099C



Fig. 0284

**Fig. 0965:**

Lens (Open Top): 0281DPAWHT.  
Lens(Closed Top): 0295DPOWHT.  
Bulbs: 0071DP0CLR.  
Base with Socket Assembly: 0135.



Fig. 0071



Fig. 0295



Fig. 0281

## LED White All-Round Navigation Lights

**2-mile (USCG 2nm) Certified** - Patent #D665,1135

Use on Power Driven Vessels Under 20m (65.6 ft.) in Length

Material: Polymer Top and Base with Clear Fluted Lens and 3/4" aluminum tube  
 Fig. 1642: Chrome Plated Zinc Alloy Base  
 Finish: Black  
 Screw Size: #8  
 Voltage: 12V LED  
 Wattage: 1.5 watts  
 Amperage: 0.1 amps

Features: 360° Reduced Glare Design  
 Fig. 1608: **Fixed Mount** - two pole length sizes  
 Fold-Down Mts: Feature adjustable angle (0° to 180°) for poles less than 18" long, include adapters available for flat or "V" type 45° mounts and a notch for through base wiring.  
 Fig. 1636: **Horizontal Mount** - Folds down 90° in either direction opposite the plane of attachment plate of the mount.  
 Fig. 1639: **Vertical Mount** - Folds down 90° in either direction along the plane of attachment plate of the mount.  
 Fig. 1642: **Quick Adjust Lever** - Ideal for use on pontoon boat square rails or any flat mounting surface.  
 Fig. 1609: **For Tower/Arch Mounts** - Serves as 360° all-round navigation light in the up position for nighttime boating or while at anchor and a cockpit courtesy light in the down position while at the dock. Stores Forward and out of the way for daytime skiing or boarding. Mounts on 7/8" diameter tubing.

### STEALTH Series



**Fig. 1639 Vertical Mt. (Shown)**

### Fixed & Folding Mount Options



**Fig. 1636 Horizontal Mount**



**Fig. 1639 Vertical Mount**



**Fig. 1642 Quick Adjust Handle**



**Fig. 1609 Tower/Arch Folding Mt.**



**Fig. 1608 Fixed Mount**



Base Mount	Height Overall	Base Dimensions	Retail Pkg.	OEM Bulk Pkg.
Fixed Mt.	7-1/4"	1" x 2-5/8"	1608DP0BLK	1608000BLK
Fixed Mt.	5-1/8"	1" x 2-5/8"	1608DP1BLK	1608001BLK
<b>Folding Mt.</b>				
Horizontal Mt.	14-1/4"	2" x 1-1/2"	1636DP0CHR	1636000CHR
Vertical Mt.	14-1/4"	2-1/4" x 5/8"	1639DP0CHR	1639000CHR
Quick Adjust	13-7/8"	2-1/4" x 5/8"	1642DP0CHR*	1642000CHR*
<b>Tower/Arch Mt.</b>				
Fixed Mt.	8-3/8"	2" x 1-1/2"	1609DP0CHR	1609000CHR

\* Refers to Prop65 Warning

Diagram of Tower/Arch Mounted Light

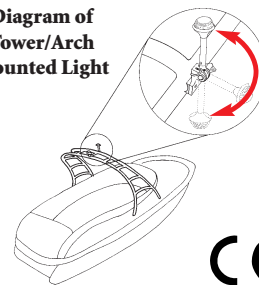

**PROP 65 WARNING**  
(Contains Lead)



### Spare Parts Information

L.E.D.'s have no user serviceable parts  
 Replacement bases for Figs. 1636, 1639 & 1642 see page 41

## White All-Round Navigation Lights

### 2-mile (USCG 2nm) Certified

Use on Power Driven Vessels Under 20m (65.6 ft.) in Length

Material: Polymer Top and Base with Frosted Lens and 3/4" aluminum tube  
 Fig. 1638: Chrome Plated Zinc Alloy Base

Finish: Black

Screw Size: #8

Voltage: 12V (Bulb Included)

Wattage: 9 watts

Amperage: .69 amps

- Features: 360° Reduced Glare Design
- Fig. 1604: **Fixed Mount** - two pole lengths
  - Fold-Down Mts: Feature adjustable angle (0° to 180°) for poles less than 18" long, include adapters available for flat or "V" type 45° mounts and a notch for through base wiring.
  - Fig. 1634: **Horizontal Mount** - Folds down 90° in either direction opposite the plane of attachment plate of the mount.
  - Fig. 1637: **Vertical Mount** - Folds down 90° in either direction along the plane of attachment plate of the mount.
  - Fig. 1638: **Quick Adjust Lever** - Ideal for use on pontoon boat square rails or any flat mounting surface.
  - Fig. 1607: **For Tower/Arch Mounts** - Serves as 360° all-round navigation light in the up position for nighttime boating or while at anchor and a cockpit courtesy light in the down position while at the dock. Stores forward and out of the way for daytime skiing or boarding. Mounts on 7/8" diameter tubing.

### 0239 Head Style Coastal Series



**Fig. 1637 Vertical Mt. (Shown)**

### Fixed & Folding Mount Options



	Height Overall	Base Dimensions	Retail Pkg.	OEM Bulk Pkg.
<b>Base Mount</b>				
Fixed Mt.	7-3/8"	1" x 2-5/8"	1604DP0CHR	1604000CHR
Fixed Mt.	3-1/8"	1" x 2-5/8"	1604DP1CHR	1604001CHR
<b>Folding Mt.</b>				
Horizontal Mt.	14-3/4"	2" x 1-1/2"	1634DP0CHR	1634000CHR
Vertical Mt.	14-1/8"	2-1/4" x 5/8"	1637DP0CHR	1637000CHR
Quick Adjust	13-7/8"	2-1/4" x 5/8"	1638DP0CHR*	1638000CHR*
<b>Tower Mt.</b>				
Fixed Mt.	8"	2" x 1-1/2"	1607DP0CHR	1607000CHR

\* Refers to Prop65 Warning

Diagram of Tower/Arch Mounted Light

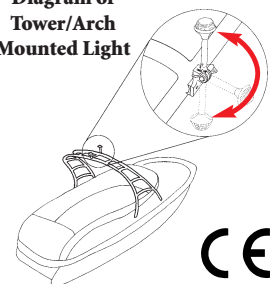

### Spare Parts Information

Bulbs: 0338DP2CLR.  
 Globe: 0239DP0BLK.

Fig. 0338



Replacement bases for Figs. 1634, 1637 & 1638 see page 41



Fig. 0239DP0BLK

## White All-Round Navigation Lights

### 2-mile (USCG 2nm) Certified

Use on Sail or Power Driven Vessels Under 20m (65.6 ft.) in Length

Material: White Translucent Polymer Globe with Polymer Top and 3/4" Anodized Aluminum Tube  
 Fig. 1138: Chrome Plated Zinc Alloy Base

Finish: Chrome and Black

Contacts: Gold Plated

Screw Size: #8

Voltage: 12V (Bulb Included)  
 12 or 24V (0170SWB Only)

Wattage: 12V      24V  
 11 watts      15 watts

Amperage: .94 amps      .63 amps

#### Features:

- Fig. 0170: **Fixed Mount** - two pole lengths, two voltages
- Fig. 1301: **Fixed Mount** - one pole length size
- Fold-Down Mts: Feature adjustable angle (0° to 180°) for poles less than 18" long, include adapters available for flat or "V" type 45° mounts and a notch for through base wiring.
- Fig. 1134: **Horizontal Mount** - Folds down 90° in either direction opposite the plane of attachment plate of the mount.
- Fig. 1137: **Vertical Mount** - Folds down 90° in either direction along the plane of attachment plate of the mount.
- Fig. 1138: **Quick Adjust Lever** - Ideal for use on pontoon boat square rails or any flat mounting surface.

### 0201 Head Style Alpha Series



**Fig. 1137  
Vertical Mt.  
(Shown)**

### Fixed & Folding Mount Options



**Fig. 1134  
Horizontal  
Mount**



**Fig. 1137  
Vertical  
Mount**



**Fig. 1138  
Quick  
Adjust Handle**



**Figs. 0170SWB  
and 1301  
Fixed Mount**

Base Mount	Voltage	Height Overall	Base Dimensions	Retail Pkg.	OEM Bulk Pkg.
Fixed Mt.	12	5-1/8"	1" x 2-5/8"	0170SWBDP1	0170SWB12V
Fixed Mt.	24	5-1/8"	1" x 2-5/8"	0170SWBDP2	0170SWB24V
Fixed Mt.	12	8-1/2"	1" x 2-5/8"	1301DP0CHR	1301000CHR
<b>Folding</b>					
Horizontal Mt.	12	15-5/8"	2" x 1-1/2"	1134DP0CHR	1134000CHR
Vertical Mt.	12	15-1/2"	2-1/4" x 5/8"	1137DP0CHR	1137000CHR
Quick Adjust Mt.	12	15-3/8"	2-1/4" x 5/8"	1138DP0CHR*	1138000CHR*

\* Refers to Prop 65 Warning



Fig. 0337



Replacement bases for Figs. 1134, 1137 & 1138 see page 41

#### Spare Parts Information

12 Volt Bulbs : 0337012DP.  
 24 Volt Bulb For Fig. 0170SWB: 0337014DP.  
 Globe: 0201DPOWHT.

Fig. 0201



## Combination Masthead/White All-Round Navigation Lights

### 3-mile (USCG 3nm) Certified

Use on Sail or Power Driven Vessels Under 20m (65.6 ft.) in Length

- Material: Polymer Top and Base, Zinc Alloy, Clear  
Polymer Lens and 3/4" Anodized Aluminum Tube
- Finish: Black and Chrome Plated
- Contacts: Gold Plated
- Screw Size: #8
- Voltage: 12V LED
- Wattage: 2.2 watts (each compartment)
- Amperage: 0.2 amps (each compartment)
- Features: Two light compartments (Masthead/Anchor)
- Fig. 1683: **Fixed Mount** - one pole length
  - Fig. 1696: **Fixed Mount** - two pole lengths
  - Fig. 1697: **Fixed Mount Short Pole** - with pigtail leads
- Fold-Down Mts: Feature adjustable angle (0° to 180°) for poles less than 18" long, include adapters available for flat or "V" type 45° mounts and a notch for through base wiring.
- Fig. 1681: **Horizontal Mount** - Folds down 90° in either direction opposite the plane of attachment plate of the mount.
  - Fig. 1684: **Vertical Mount** - Folds down 90° in either direction along the plane of attachment plate of the mount.

### 1696 Head Style



**Fig. 1684**  
**Vertical Mt.**  
(Shown)

### Fixed & Folding Mount Options



**Fig. 1681**  
**Horizontal**  
**Mount**



**Fig. 1684**  
**Vertical**  
**Mount**



**Fig. 1697**  
**Fixed Mt.**  
**Short Pole**



**Figs. 1683**  
**and 1696**  
**Fixed Mount**

Base Mount	Height Overall	Base Dimensions	Retail Pkg.	OEM Bulk Pkg.
Fixed Mt.	3-3/8"	1" x 2-5/8"	1683DP0CHR	1683000CHR
Fixed Mt.	5-3/8"	1" x 2-5/8"	1696DP1CHR	1696001CHR
Fixed Mt.	11-5/8"	1" x 2-5/8"	1696DP2CHR	1696002CHR
Fixed w/Pigtail	4-1/8"	3/4" Dia.	1697DP0CHR	1697000CHR
<b>Folding</b>				
Horiz. Mt.	13-1/2"	2" x 1-1/2"	1681DP0CHR	1681000CHR
Vert. Mt.	13-3/8"	2-1/4" x 5/8"	1684DP0CHR	1684000CHR

**Wiring Note:** When choosing LED upgrades to replace existing incandescent combination masthead/all-round lights, optional Cat. No. 1680DP012V Converter Module is available to avoid re-wiring the navigation light switch.

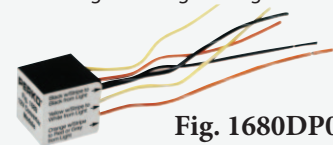

**Fig. 1680DP012V**

### Spare Parts Information

L.E.D.'s have no user serviceable parts

Replacement bases for Figs. 1681 & 1684 see page 41

## Combination Masthead/White All-Round Navigation Lights

### 3-mile (USCG 3nm) Certified

Use on Sail or Power Driven Vessels Under 20m (65.6 ft.) in Length

- Material: Polymer Top and Base, Zinc Alloy, Clear Polymer Lens and 3/4" Anodized Aluminum Tube
- Finish: Black and Chrome Plated
- Contacts: Gold Plated
- Screw Size: #8
- Voltage: 12V (Two Bulbs Included)
- Wattage: 10 watts (each compartment)
- Amperage: .80 amps (each compartment)

Features: Two light compartments (Masthead/Anchor)

- Fig. 1183: **Fixed Mount** - one pole length
- Fig. 1196: **Fixed Mount** - two pole lengths
- Fig. 1197: **Fixed Mount Short Pole** - with pigtail leads
- Fig. 1201: **Fixed Mount** - Tri-color light

Fold-Down Mts: Feature adjustable angle (0° to 180°) for poles less than 18" long, include adapters available for flat or "V" type 45° mounts and a notch for through base wiring.

Fig. 1181: **Horizontal Mount** - Folds down 90° in either direction opposite the plane of attachment plate of the mount.

Fig. 1184: **Vertical Mount** - Folds down 90° in either direction along the plane of attachment plate of the mount.

### 1196 Head Style



**Fig. 1184**  
**Vertical Mt.**  
(Shown)

### Fixed & Folding Mount Options



**Fig. 1181**  
**Horizontal**  
**Mount**



**Fig. 1184**  
**Vertical**  
**Mount**



**Fig. 1197**  
**Fixed Mt.**  
**Short Pole**



**Figs. 1183**  
**and 1196**  
**Fixed Mount**



Base Mount	Height Overall	Base Dimensions	Retail Pkg.	OEM Bulk Pkg.
Fixed Mt.	4"	1" x 2-5/8"	1183DP0CHR	1183000CHR
Fixed Mt.	6"	1" x 2-5/8"	1196DP1CHR	1196001CHR
Fixed Mt.	12-3/16"	1" x 2-5/8"	1196DP2CHR	1196002CHR
Fixed w/Pigtail	4-7/8"	3/4" Dia.	1197DP0CHR	1197000CHR
<b>Folding</b>				
Horiz. Mt.	14-1/4"	2" x 1-1/2"	1181DP0CHR	1181000CHR
Vert. Mt.	14"	2-1/4" x 5/8"	1184DP0CHR	1184000CHR
<b>Tri-Color Light</b>				
Fixed Mt.	4-1/8"	1" x 2-5/8"	1201DP0BLK	-----

### Tri-Color Light 2-mile (USCG 2nm) Certified

Use on Vessels Under Sail Alone Under 12m (39.4 ft.) in Length



**Fig. 1201**

NOTE: All of the above can also be used as 24-volt A.B.Y.C. A-16 certified lights on boats built prior to 11/1/03. Replace the bulbs provided with Cat. No. 0072DP1CLR 24-volt bulbs. Contact us for 24 volt applications for new construction.

### Spare Parts Information

12V Bulbs: 0071DP0CLR.

Lenses: 0278DP0WHT.

Top Cap with Screw: 1158DP0BLK.

Fig. 1201: Bi-Color Lens Set (Red/Green): 0268DP0LNS.

Replacement bases for Figs. 1181 & 1184 see page 41



Fig. 0071DP0CLR



Fig. 0268



Fig. 0278



## Combination Masthead/White All-Round Navigation Lights

### 2-mile (USCG 2nm) Certified

Use on Power Driven Vessels Under 12m (39.4 ft.) in Length

Material: Polymer Top and Base, Clear Polymer Lens and 3/4" Anodized Aluminum Tube  
 Finish: Black  
 Contacts: Gold Plated  
 Screw Size: #8  
 Voltage: 12V (Two Bulbs Included)  
 Wattage: 5 watts (each compartment)  
 Amperage: .35 amps (each compartment)

Features: Reduced Glare™ Design™  
 Two light compartments (Masthead/Anchor)

Fig. 1236: **Fixed Mount** - two pole length sizes

Fig. 1283: **Fixed Mount** - one pole length size

Fold-Down Mts: Feature adjustable angle (0° to 180°) for poles less than 18" long, include adapters available for flat or "V" type 45° mounts and a notch for through base wiring.

Fig. 1281: **Horizontal Mount** - Folds down 90° in either direction opposite the plane of attachment plate of the mount.

Fig. 1284: **Vertical Mount** - Folds down 90° in either direction along the plane of attachment plate of the mount.

### 0240 Head Style



2  
Navigation Lights

### Fixed & Folding Mount Options



**Fig. 1281  
Horizontal  
Mount**



**Fig. 1284  
Vertical  
Mount**



**Figs. 1236 &  
1283  
Fixed Mount**

**Fig. 1284  
Vertical Mt.  
(Shown)**

Base Mount	Height Overall	Base Dimensions	Retail Pkg.	OEM Bulk Pkg.
Fixed Mt.	5"	1" x 2-5/8"	1236DP1BLK	1236001BLK
Fixed Mt.	11-3/8"	1" x 2-5/8"	1236DP2BLK	1236002BLK
Fixed Mt.	3"	1" x 2-5/8"	1283DP0BLK	1283000BLK
<b>Folding</b>				
Horiz. Mt.	13-1/4"	2" x 1-1/2"	1281DP0CHR	1281000CHR
Vert. Mt.	13-1/8"	2-1/4" x 5/8"	1284DP0CHR	1284000CHR



#### Spare Parts Information

Bulbs (2 per card): 0338DP1CLR.  
 Lens Assembly: 0240DPOLNS.

Fig. 0338



Replacement bases for Figs. 1636 & 1639 see page 41



Fig. 0240

## Fold Down Pole Light Mounting Base Options

2  
Navigation Lights

### Horizontal Mount Bases

Folds down 90° in either direction **opposite** the plane of attachment plate of the mount

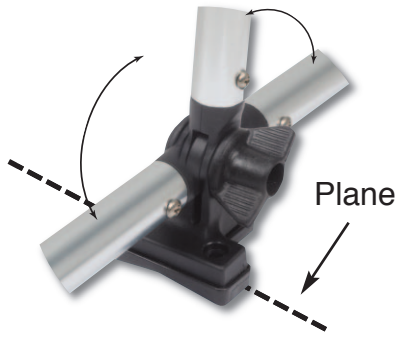

**Standard Duty**



**Heavy Duty**

### Vertical Mount Bases

Folds down 90° in either direction **along** the plane of attachment plate of the mount

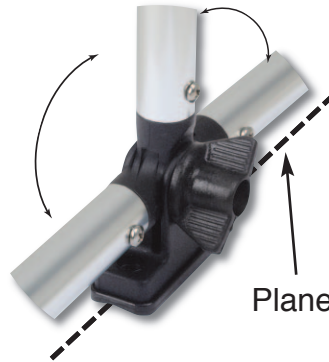

**Standard Duty**



**Heavy Duty**

### Vertical Mount Base with Quick Adjust Handle

Folds down 90° in either direction **along** the plane of attachment plate of the mount

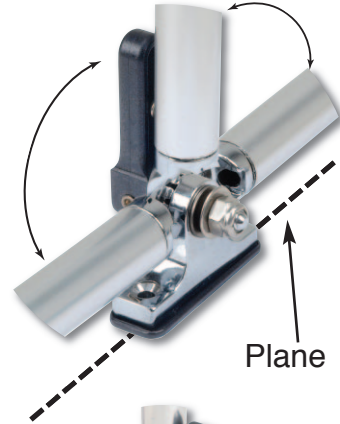

**Heavy Duty**

### Rail Mount Bases for Vertical Mount Folding Lights

Unique polymer block allows for easy mounting on 3/4" diameter rails

- Material: Polymer
- Finish: Black
- Mounting Hdwe: 6 screws included (4 clamping, 2 mounting)
- Fits: 3/4" diameter rails\*

**Features:**

Both bases fit: Perko Fig. Nos. 1137, 1138, 1184, 1284, 1637, 1638, 1639, & 1642 Folding Mount lights

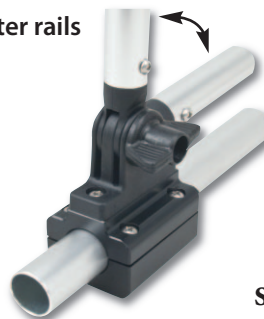

**In-Line or Axial Mt.**

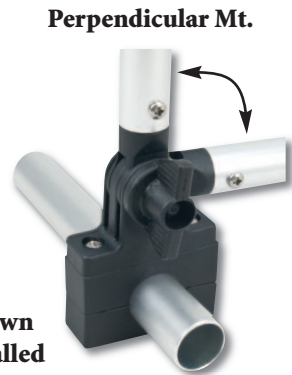

**Perpendicular Mt.**

**Shown Installed**



**Fig. 1627**



**Fig. 1628**

Rail Mount	Base Dimensions	OEM Bulk Pkg.
In-Line	2-3/8" x 1-3/4" x 1-3/8"	1627000BLK
Perpendicular	2-5/16" x 3/4" x 1-1/4"	1628000BLK

\* Other rail tubing diameters available by special order.  
Note: Pole light and folding base not included.

# Fold-Down Adjustable Replacement Bases

## Fold-Down Adjustable Mount Bases

Material: Zinc Alloy & Polymer or All Polymer  
 Finish: Chrome Plated or Black  
 Screw Size: #8  
 Base Dimension: Horizontal Mt.: 2" x 1-1/2"  
 Vertical Mt.: 2-1/4" x 5/8"  
 Features: Complete with knob, end plug, and adapter for "V" or flat mounting surfaces.

**Heavy Duty:**

- Chrome plated zinc alloy base 30° graduated adjustment increments.
- For poles less than 48" long.
- Consult factory for ordering details.

Figs. 1052/1054: Does NOT contain notch for through base wiring.  
 Fig. 1052 Fits Figs. 1134 & 1634  
 Fig. 1054 Fits Figs. 1137 & 1637

Figs. 1052A/1054A: Contains notch for through base wiring.  
 Fig. 1052A Fits Figs. 1181 & 1281  
 Fig. 1054A Fits Figs. 1184 & 1284

**Standard Duty:**

- All black base with 0° to 180° adjustment.
- For poles less than 18" long.

Figs. 1052B/1054B: Contains notch for through base wiring.  
 Universal mounting bases - fits all fold down series poles.



**Fig. 1052**  
Horizontal



**Fig. 1054**  
Vertical



**Fig. 1052A**  
Horizontal



**Fig. 1054A**  
Vertical

Notch

Notch



**Fig. 1052B**  
Horizontal



**Fig. 1054B**  
Vertical

Notch

## Quick Release Fold-Down Adjustable Mount Base

Features:

- Fits Figs. 1138, 1638, & 1642
- Quick adjust handle (with 30° graduated adjustment increments) allows pole light to fold down 90° in either direction along the plane of attachment plate of the mount.
- Ideal for use on pontoon boat square rails or any flat mounting surface.
- For poles less than 48" long

Through Base Wiring	Finish	Mount	Retail Pkg.
<b>Heavy Duty</b>			
No	Chrome	Horiz.	1052DP0CHR
No	Chrome	Vertical	1054DP0CHR
Yes	Chrome	Horiz.	1052DPACHR
Yes	Chrome	Vertical	1054DPACHR
<b>Standard Duty</b>			
Yes	Black	Horiz.	1052DPBBLK
Yes	Black	Vertical	1054DPBBLK
<b>Quick Release Handle</b>			
No	Chrome	Vertical	1058DP0CHR*



**Fig. 1058**  
Quick Release  
Vertical

**PROP 65**  
**WARNING**  
(Contains Lead)

Spare knob for zinc alloy bases: 1144A00BLK.

\* Refers to Prop65 Warning

## White All-Round Navigation Lights - Fixed Mount

### 2-mile (USCG 2nm) Certified - "Reduced Glare" Design

Use on Sail or Power Driven Vessels Under 20m (65.6 ft.) in Length

- Material: Polymer and Aluminum, Clear Fluted Lens and Frosted Globe
- Finish: White or Black
- Dimensions: Fig. 1342: Height: 5-3/8" Base O.D.: 1-1/2"  
Fig. 1345: Height: 8-1/4", Base: 1" x 2-5/8"
- Tube: 3/4" Anodized Aluminum
- Screw Size: #8
- Voltage: 12V LED
- Wattage: 4.5 watts
- Amperage: 0.35 amps
- Features: 360° "Reduced Glare" Design  
Fig. 1342: **Pipe Mount** - for 3/4" Pipe  
Fig. 1345: **Fixed Mount**



Fig. 1342

Fig. 1345

Base Mount	Voltage	Retail Pkg.	OEM Bulk Pkg.
Fixed Mt.	12	1345DP1WHT	1345001WHT
3/4" Pipe	12	-----	1342001BLK
3/4" Pipe	24	-----	1342002BLK

L.E.D.'s have no user serviceable parts



### 2-mile (USCG 2nm) Certified

Use on Power Driven Vessels Under 20m (65.6 ft.) in Length

- Material: Polymer Top and Base, Clear Fresnel Globe  
Size #2: 3/4" Anodized Aluminum
- Finish: Black
- Dimensions: Height Size 1: 5-5/8", Base O.D.: 2-1/8"  
Height Size 2: 13"
- Contacts: Gold Plated
- Screw Size: #8
- Voltage: 12V (Bulb Included)
- Wattage: 7 watts
- Amperage: .58 amps
- Features: **Fixed Mount** - two pole length sizes



Fig. 0455 #1

Fig. 0455 #2

Retail Pkg.	OEM Bulk Pkg.
0455DP1CHR	0455001CHR
0455DP2CHR	0455002CHR



Fig. 0337



#### Spare Parts Information

FIG. 0455:

Bulbs: 0337011DP.  
Globe: 0248DP0CLR.



Fig. 0248

# Choosing A Replacement Pole Light

## 1. Select a Globe Style



- Globes come in 3 basic types:
1. White all-round Full Output allows for full cockpit illumination.
  2. White all-round Reduced Glare helps preserve night vision while under way.
  3. Bi-Color lights are used on the bow instead of a fixed surface mount light. Choose from models with or without integral white utility light.

## 2. Select a Rake Angle



Rake is determined by the pole, base and base location angles. Rake is important for all reduced glare lights to insure that light output is correct. The most common rake angles are 0°, 5° and 16°. Custom made poles often have non-standard rake angles. Choose from 0°, 5°, 16°, 45° or fully adjustable versions (Delta, Stealth, and Omega Series).

## 3. Determine if the Key Slot Screw Position is Important

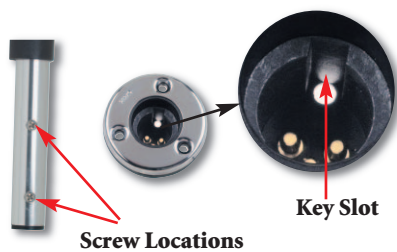

Most manufacturers insert screws into an upper or lower location on the pole to position the light and hold it properly oriented in the base. The location of this screw varies by manufacturer and model. Determine the key slot screw position needed for your base and match it to the pole you select. All Perko plug in bases accept the upper screw position and all Perko lights have an upper screw. Perko Alpha, Delta, Omega, and Stealth Series replacement lights offer the option to locate the screw in either place.

## 4. Determine the Pole Length

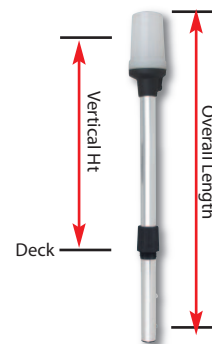

Navigation rules state that the center of the bulb filament of white lights must be mounted at least 1 meter (approx 40") above center of the filament of the red/green lights. The "vertical height" of a light is measured from the deck of the boat to the center of the light filament. Most pole lights (all of Perko's) are sold by their "nominal (or approximate) overall length". Three factors affect the difference between overall length and vertical height. 1) The depth the pole goes into the base is (typically less than two inches). 2) The distance from the filament to the top of the light is (typically less than an inch). 3) Rake angle can shorten the vertical height by as much as an inch (for bends under 16 degrees). So, as a general rule, the installed "vertical height" will be between 2 and 4 inches less than the nominal length of the pole. Select the shortest light that will insure that the requirements are met after taking this difference into account. Be sure the light is long enough to be seen over any obstructions. If this light is too long to store easily, consider a fold-in-half light for easier storage.

## 5. Determine a Collar Type



Some manufacturers use different types of collars to assure that their pole lights are held securely in the base. All Perko lights are shipped with at least one collar (a locking collar, a large threaded collar, or a small threaded collar). Determine whether a collar is needed for your base and match it by collar type to the pole you select. All Perko bases require collars.

## 6. Determine the Number of Pins



Bi-color lights are available with and without an integral white utility light. Those lights with a utility light require 3 contact pins. Determine if 2 or 3 contact pins are needed for your base and match it to the pole you select.

## LED White All-Round Navigation Lights - Removable Plug-in Mount

**2-mile (USCG 2nm) Certified** - Patent #D6652,161S  
 Use on Power Driven Vessels Under 20m (65.6 ft.) in Length

**Material:** Polymer Top and Collar with Clear Fluted Lens and 3/4" Aluminum Tube  
**Contacts:** Gold Plated  
**Voltage:** 12V LED  
**Wattage:** 1.5 watts  
**Amperage:** 0.1 amps  
**Base (2-Pin):** Locking collar fits Figs.1045, 1046, 1047, 1059, & 1060 bases  
 Threaded collar fits Fig. 1048 base

**Features:** The "Reduced Glare" design helps preserve night vision by reducing the amount of light wasted outside of the visibility zone and not attracting as many bugs.  
 LED: Sealed from the Environment

**Retail Pkg.:** **STEALTH** series universal replacement lights are designed to fit most other manufacturers' bases. They feature two collars (one threaded and one locking), two screw positions, and an adjustable head (wide 40°). Adjustability of the globe allows for proper horizontal alignment regardless of base configuration.

**OEM Bulk Pkg.:** These lights have fixed pole light heads with either 0° or 5° pole rake and single locking or threaded collar

**STEALTH Series**



**Fig. 1442 (Shown)**  
 Locking Collar  
 0° Rake  
 OEM Bulk Pkg.

**Fig. 1347 (Shown)**  
 Adj. Head  
 2 Collars  
 Retail Pkg.

Approx. Pole Length	Catalog Number	Pole Rake, Collar, & Pkg. Type	
24	1347DP2CHR		
36	1347DP4CHR	Pole Rake:	Adjustable
42	1347DP5CHR	Collar:	Locking & Threaded
48	1347DP6CHR	Package Type:	Retail
54	1347DP7CHR		
24	1442002CHR		
30	1442003CHR		
36	1442004CHR	Pole Rake:	0°
42	1442005CHR	Collar:	Locking
48	1442006CHR	Package Type:	OEM Bulk
54	1442007CHR		
60	1442008CHR		
24	1447002CHR		
30	1447003CHR		
36	1447004CHR	Pole Rake:	5°
42	1447005CHR	Collar:	Locking
48	1447006CHR	Package Type:	OEM Bulk
54	1447007CHR		
60	1447008CHR		
36	1624004CHR	Pole Rake:	5°
42	1624005CHR	Collar:	Threaded
48	1624006CHR	Package Type:	OEM Bulk
54	1624007CHR		
60	1624008CHR		

### Compatible Bases (2-Pin)



**Fig. 1045**  
 0° Rake

**Fig. 1047**  
 0° Rake

**Fig. 1059**  
 16° Rake

**Fig. 1046**  
 5° Rake

**Fig. 1060**  
 5° Rake

**Fig. 1048**  
 5° Rake

### Spare Parts Information

L.E.D.'s have no user serviceable parts

Bases Sold Separately - See Pages 58 & 59.

# LED White All-Round Navigation Lights - Removable Plug-in Mount

## 2-mile (USCG 2nm) Certified

Use on Power Driven Vessels Under 20m (65.6 ft.) in Length

**Material:** Polymer Top and Collar with Clear Fluted Lens, Frosted Top, and 3/4" Aluminum Tube  
**Contacts:** Gold Plated  
**Voltage:** 12V LED  
**Wattage:** 4.5watts  
**Amperage:** 0.35 amps  
**Base (2-Pin):** Locking collar fits Figs.1045, 1046, 1047, 1059, & 1060 bases  
 Threaded collar fits Fig. 1048 base

**Features:** The "Reduced Glare" advanced globe design helps preserve night vision by reducing the amount of light wasted outside of the visibility zone and offers improved visibility when in rough water and from above.

LED: Sealed from the Environment

**Retail Pkg.:** **Omega Series** - Universal replacement lights are designed to fit most other manufacturers' bases. They feature two collars (one threaded and one locking), two screw positions, and an adjustable head (wide 40°). Adjustability of the globe allows for proper horizontal alignment regardless of base configuration.

**OEM Bulk Pkg.:** These lights have fixed pole light heads with either 0° or 5° pole rake and single locking or threaded collar

Approx. Pole Length	Catalog Number	Pole Rake, Collar, & Pkg. Type	
36	1343DP4CHR	Pole Rake:	Adjustable
48	1343DP6CHR	Collar:	Locking & Threaded
		Package Type:	Retail
24	1440L02CHR		
30	1440L03CHR		
36	1440L04CHR	Pole Rake:	0°
42	1440L05CHR	Collar:	Locking
48	1440L06CHR	Package Type:	OEM Bulk
54	1440L07CHR		
60	1440L08CHR		
24	1445L02CHR		
30	1445L03CHR	Pole Rake:	5°
36	1445L04CHR	Collar:	Locking
42	1445L05CHR	Package Type:	OEM Bulk
48	1445L06CHR		
54	1445L07CHR		
60	1445L08CHR		
36	1622L04CHR	Pole Rake:	5°
42	1622L05CHR	Collar:	Threaded
48	1622L06CHR	Package Type:	OEM Bulk
54	1622L07CHR		
60	1622L08CHR		

Omega LED Style



**Fig. 1343 (Shown)**  
Adj. Head  
2 Collars  
Retail Pkg.

**Fig. 1622L (Shown)**  
Threaded Collar  
5° Rake  
OEM Bulk Pkg.

### Compatible Bases (2-Pin)



**Fig. 1045**  
0° Rake

**Fig. 1047**  
0° Rake

**Fig. 1059**  
16° Rake

**Fig. 1046**  
5° Rake

**Fig. 1060**  
5° Rake

**Fig. 1048**  
5° Rake

### Spare Parts Information

L.E.D.'s have no user serviceable parts

Bases Sold Separately - See Pages 58 & 59.

## White All-Round Navigation Lights - Removable Plug-in Mount

### 2-mile (USCG 2nm) Certified

Use on Power Driven Vessels Under 20m (65.6 ft.) in Length

- Material:** Polymer Top and Collar with Clear Fluted Lens, Frosted Top, and 3/4" Aluminum Tube
- Contacts:** Gold Plated
- Voltage:** 12V (Bulb Included)
- Wattage:** 9 watts
- Amperage:** .69 amps
- Base (2-Pin):** Locking collar fits Figs.1045, 1046, 1047, 1059, & 1060 bases  
Threaded collar fits Fig. 1048 base
- Features:** The Reduced Glare advanced globe design helps preserve night vision by reducing the amount of light wasted outside of the visibility zone and offers improved visibility when in rough water and from above.

**Retail Pkg.:** **Delta Series** - Universal replacement lights are designed to fit most other manufacturers' bases. They feature two collars (one threaded and one locking), two interchangeable globes (one reduced glare and one full output), two screw positions, and an adjustable head (wide 40°). Adjustability of the globe allows for proper horizontal alignment regardless of base configuration. Delta's list of features put it in a class by itself. **No Other** pole light system offers more.



**OEM Bulk Pkg.:** **Coastal Series** - These lights have fixed pole light heads with either 0° or 5° pole rake and single locking or threaded collar.

Approx. Pole Length	Catalog Number	Pole Rake, Collar & Pkg. Type	
24	1470DP2CHR		
36	1470DP4CHR	Pole Rake:	Adjustable
42	1470DP5CHR	Collar:	Locking & Threaded
48	1470DP6CHR	Package Type:	Retail
54	1470DP7CHR		
24	1460002CHR		
30	1460003CHR		
36	1460004CHR	Pole Rake:	0°
42	1460005CHR	Collar:	Locking
48	1460006CHR	Package Type:	OEM Bulk
54	1460007CHR		
60	1460008CHR		
24	1465002CHR		
30	1465003CHR		
36	1465004CHR	Pole Rake:	5°
42	1465005CHR	Collar:	Locking
48	1465006CHR	Package Type:	OEM Bulk
54	1465007CHR		
60	1465008CHR		
36	1656004CHR		
42	1656005CHR	Pole Rake:	5°
48	1656006CHR	Collar:	Threaded
54	1656007CHR	Package Type:	OEM Bulk
60	1656008CHR		

0239 Style  
Delta & Coastal Series



**Fig. 1470 (Shown)**  
Adj. Head  
2 Collars  
Retail Pkg.

**Fig. 1465 (Shown)**  
Locking Collar  
5° Rake  
OEM Bulk Pkg.

### Compatible Bases (2-Pin)



**Fig. 1045**  
0° Rake

**Fig. 1047**  
0° Rake

**Fig. 1059**  
16° Rake



**Fig. 1046**  
5° Rake

**Fig. 1060**  
5° Rake

**Fig. 1048**  
5° Rake

### Spare Parts Information

Bulbs: 0338DP2CLR  
Clear Globe: 0239DP0CLR  
Black/Clear Globe: 0239DP0BLK.



Bases Sold Separately - See Pages 58 & 59.





## White All-Round Navigation Lights - Removable Plug-in Mount



### 2-mile (USCG 2nm) Certified

Use on Sail or Power Driven Vessels Under 20m (65.6 ft.) in Length

- Material: Black Top and Collar, White Translucent Globe, and 3/4" Anodized Aluminum Tube
- Contacts: Gold Plated
- Voltage: 12V (Bulb Included)
- Wattage: 11 watts
- Amperage: .94 amps
- Base (2-Pin): Locking collar fits Figs. 1045, 1046, 1047, 1059, & 1060 bases  
Threaded collar fits Fig. 1048 base

Features: Traditional white translucent globe allows for all round visibility even when globe orientation is not horizontally aligned. In addition, this design also provides limited cockpit illumination.

**Retail Pkg.:** **Alpha Series** - Universal replacement lights are designed to fit most other manufacturers' bases. They feature two collars (one threaded and one locking), two screw positions, and a full output translucent globe (360°).



**OEM Bulk Pkg.:** These lights have fixed pole light heads with 0° pole rake and single locking or threaded collar.

Approx. Pole Length	Catalog Number	Pole Rake, Collar, & Pkg. Type
24	1400DP2CHR	Pole Rake: Adjustable Collar: Locking & Threaded Package Type: Retail
30	1400DP3CHR	
36	1400DP4CHR	
42	1400DP5CHR	
48	1400DP6CHR	
54	1400DP7CHR	
60	1400DP8CHR	
24	1403002CHR	Pole Rake: 0° Collar: Threaded Package Type: OEM Bulk
30	1403003CHR	
36	1403004CHR	
42	1403005CHR	
48	1403006CHR	
54	1403007CHR	
60	1403008CHR	
24	1404002CHR	Pole Rake: 0° Collar: Locking Package Type: OEM Bulk
30	1404003CHR	
36	1404004CHR	
42	1404005CHR	
48	1404006CHR	
54	1404007CHR	
60	1404008CHR	

0201 Style  
Alpha Series



**Fig. 1400**  
(Shown)  
Retail Pkg.

**Fig. 1404**  
(Shown)  
Locking Collar  
0° Rake  
OEM Bulk Pkg.

### Compatible Bases (2-Pin)



**Fig. 1045**  
0° Rake

**Fig. 1047**  
0° Rake

**Fig. 1059**  
16° Rake

**Fig. 1046**  
5° Rake

**Fig. 1060**  
5° Rake

**Fig. 1048**  
5° Rake

### Spare Parts Information

Bulbs: 0337012DP.  
White Translucent Globe: 0201DP0WHT.



Fig. 0201



Fig. 0337

Bases Sold Separately - See Pages 58 & 59.

## White All-Round Navigation Lights - Removable Plug-in Mount

### 2-mile (USCG 2nm) Certified

Use on Power Driven Vessels Under 20m (65.6 ft.) in Length

- Material:** Polymer Top and Collar with Clear Fluted Lens and 3/4" Aluminum Tube
- Contacts:** Gold Plated
- Tube:** 3/4" Anodized Aluminum
- Voltage:** 12V (Bulb Included)
- Wattage:** 9 watts
- Amperage:** .69 amps
- Base (2-Pin):** Locking collar fits Figs.1045, 1046, 1047, & 1060 bases  
Threaded collar fits Fig. 1048 base
- Features:** The Original Reduced Glare advanced globe design helps preserve night vision by reducing the amount of light wasted outside of the visibility zone and not attracting as many bugs.

0238 Style  
Inland Series



**Fig. 1440**  
(Shown)  
Locking Collar  
0° Rake

**Fig. 1445**  
(Shown)  
Locking Collar  
5° Rake

Approx. Pole Length	Catalog Number	Pole Rake, Collar, & Pkg. Type
24	1440002CHR	
30	1440003CHR	
36	1440004CHR	Pole Rake: 0°
42	1440005CHR	Collar: Locking
48	1440006CHR	Package Type: OEM Bulk
54	1440007CHR	
60	1440008CHR	
24	1445002CHR	
30	1445003CHR	
36	1445004CHR	Pole Rake: 5°
42	1445005CHR	Collar: Locking
48	1445006CHR	Package Type: OEM Bulk
54	1445007CHR	
60	1445008CHR	
36	1622004CHR	Pole Rake: 5°
42	1622005CHR	Collar: Threaded
48	1622006CHR	Package Type: OEM Bulk
54	1622007CHR	
60	1622008CHR	

### Compatible Bases (2-Pin)



**Fig. 1045**  
0° Rake



**Fig. 1047**  
0° Rake



**Fig. 1046**  
5° Rake



**Fig. 1060**  
5° Rake



**Fig. 1048**  
5° Rake

Bases Sold Separately - See Pages 58 & 59.



Fig. 0238



### Spare Parts Information

Bulbs: 0338DP2CLR.  
Globe: 0238DP0BLK.



Fig. 0338

## White All-Round Navigation Lights - Removable Plug-in Mount

### 2-mile (USCG 2nm) Certified

Use on Power Driven Vessels Under 20m (65.6 ft.) in Length

- Material: Fig. 1209: Brass and Polymer  
Fig. 1330: Zinc Alloy and Polymer
- Finish: Chrome Plated and Black
- Tube: 3/4" Anodized Aluminum
- Contacts: Gold Plated
- Screw Size: #8
- Voltage: 12V (Bulb Included)
- Wattage: 7 watts
- Amperage: .58 amps
- Base (2-Pin): Included
- Features: Stow-A-Way Plug-In Type pole.
- Fig. 1209: Waterproof cover for base that attaches to deck mounted retainer when light is in place.
- Fig. 1330: Waterproof snap on cover.

Approx. Pole Length	Retail Pkg.	OEM Bulk Pkg.	Pole Rake & Base Dimensions
24"	1209DP2CHR	1209002CHR	Pole Rake: 16° Base: 3-3/8" x 2-1/4"
30"	1209DP3CHR	1209003CHR	
36"	1209DP4CHR	1209004CHR	
24"	1330DP2CHR	1330002CHR	Pole Rake: 16° Base: 3-3/4" x 1-5/8"
30"	1330DP3CHR	1330003CHR	
36"	1330DP4CHR	1330004CHR	

Bulbs: 0337011DP.  
Globe: 0248DP0CLR.  
Fig. 1209 Bulb Socket: 0024DP2.  
Fig. 1209 Cap for Base: 0125DP0BLK.  
Fig. 1209 Base: 1209DP099A  
Fig. 1330 Base 1059P00DP.

#### Spare Parts Information

Fig 1209 Poles Only:  
Size 2: 1209DP299A.  
Size 3: 1209DP399A.  
Size 4: 1209DP499A.

Fig 1330 Poles Only:  
Size 2: 1330DP299A  
Size 3: 1330DP399A.  
Size 4: 1330DP499A.



**PROP 65 WARNING**  
(Contains Lead & DINP)



Fig. 1330



Fig. 0248 Fig. 1209-99A Fig. 1059 Fig. 0337

### Pole Light Storage Clips

Great for storing pole lights, gaffs, deck brushes and other boat accessories with pole handles

- Material: Soft Black or White U.V. Stabilized Polymer
- Finish: Black or White
- For Tube Dia.: 3/4 or 7/8 Inch
- Screw Size: #10 P.H.
- Dimensions: 3/4" x 2-1/4" x 1-5/8"



Fig. 0477



Black



White

For Pole Dia. O.D. Size	Color	Retail Pkg.*	OEM Bulk Pkg.*
3/4	Black	0477DP0BLK	0477000BLK
3/4	White	0477DP0WHT	0477000WHT
7/8	Black	0477DP1BLK	-----

**PROP 65 WARNING**  
(Contains DINP)

\*Sold in pairs.

## White All-Round Navigation Lights - Telescoping Pole Lights

### 2-mile (USCG 2nm) Certified

Use on Sail or Power Driven Vessels Under 20m (65.6 ft.) in Length

Material: Polymer Top and Collar, White Polymer Translucent Globe, Zinc alloy base  
 Finish: Black and Chrome Plated  
 Tube: 3/4" Anodized Aluminum  
 Voltage: 12V (Bulb Included)  
 Wattage: 11 watts  
 Amperage: .94 amps  
 Base: Included

Features: Telescoping pole with traditional white translucent globe allows for all round visibility even when globe orientation is not horizontally aligned. In addition, this design also provides limited cockpit illumination.

Approx. Pole			
Length	Retail Pkg.	OEM Bulk Pkg.	Pole Rake & Base Dimensions
24"	1611DP2CHR	1611002CHR	Pole Rake: 16° Base: 3-3/4" x 1-5/8"
30"	1611DP3CHR	1611003CHR	
36"	1611DP4CHR	1611004CHR	



**Fig. 1611**  
16° Rake  
Telescoping

### 2-mile (USCG 2nm) Certified

Use on Power Driven Vessels Under 20m (65.6 ft.) in Length

Material: Polymer Top and Collar, Zinc alloy base  
 Fig. 1311: Clear Fresnel Globe  
 Fig. 1361: "Reduced Glare Globe"  
 Finish: Chrome Plated, Black  
 Tube: 3/4" Anodized Aluminum  
 Screw Size: #8  
 Voltage: 12V (Bulb Included)  
 Fig. 1311 Fig. 1361  
 Wattage: 7 watts 9 watts  
 Amperage: .58 amps .69 amps  
 Base: Included Included

Features:

Fig. 1311: Telescoping pole with locking collar and clear fresnel globe allows for all round visibility even when globe orientation is not horizontally aligned. In addition, this design also provides limited cockpit illumination.

Fig. 1361: Telescoping pole, locking collar with "Reduced Glare" advanced design globe that helps preserve night vision by reducing the amount of light wasted outside of the visibility zone and offers improved visibility when in rough water and from above.

Approx. Pole			
Length	Retail Pkg.	OEM Bulk Pkg.	Pole Rake & Base Dimensions
24"	1311DP2CHR	1311002CHR	Pole Rake: 16° Base: 3-3/4" x 1-5/8"
30"	1311DP3CHR	1311003CHR	
36"	1311DP4CHR	1311004CHR	
24"	1361DP2CHR	1361002CHR	Pole Rake: 16° Base: 3-3/4" x 1-5/8"
30"	1361DP3CHR	1361003CHR	
36"	1361DP4CHR	1361004CHR	



**Fig. 1311**  
16° Rake  
Telescoping

**NEW PRODUCT**  
**Fig. 1361**  
16° Rake  
Telescoping

### Spare Parts Information

**FIG. 1611:**

Bulbs: 0337012DP.  
 Globe: 0201DP0WHT.  
 Telescoping Base: 1059T00DP

**FIG. 1311:**

Bulbs: 0337011DP  
 Fresnel Globe: 0248DP0CLR  
 Telescoping Base: 1059T00DP

**FIG. 1361**

Bulbs: 0338DP2CLR  
 Black/Clear Globe: 0239DP0BLK.  
 Telescoping Base: 1059T00DP



## Combination Masthead/White All-Round Navigation Lights -Plug-in Mount Bases

### 3-mile (USCG 3nm) Certified

Use on Sail or Power Driven Vessels Under 20m (65.6 ft.) in Length

- Material: Figs. 1123/24: Polymer Top and Zinc Alloy  
 Fig. 1125: Polymer Top and Zinc Alloy Top, Brass Base  
 Fig. 1625: Polymer Top and Zinc Alloy Top, Brass Base
- Finish: Black and Chrome Plated
- Contacts: Gold Plated
- Tube: 3/4" Anodized Aluminum
- Screw Size: #8
- Voltage: 12V LED 12V Incandescent (two bulbs incl.)
- Wattage: 2.2 watts (ea. compartment) 10 watts (each compartment)
- Amperage: 0.2 amps. (ea. compartment) 80 amps (each compartment)
- Features: Two light compartments (Masthead/Anchor)
- Fig. 1123: Horizontal mount
  - Fig. 1124: Vertical mount
  - Fig. 1125: Deck mount plug-in base with waterproof cover for base that attaches to deck mounted retainer when light is in place.
  - Fig. 1625: LED light, deck mount plug-in base with waterproof cover for base that attaches to deck mounted retainer when light is in place. (See wiring note below.)



Base Mount	Approx. Pole Length	Pole Rake	Base Dimensions	Retail Pkg.	OEM Bulk Pkg.
Horiz. Mt.	15"	45°	2-1/4" x 3/4"	1123DP1CHR	1123001CHR
Horiz. Mt.	28"	45°	2-1/4" x 3/4"	1123DP2CHR	1123002CHR
Vert. Mt.	15"	45°	3/4" x 2-1/4"	1124DP1CHR	1124001CHR
Vert. Mt.	28-3/4"	45°	3/4" x 2-1/4"	1124DP2CHR	1124002CHR
Deck Mt.	35-7/8"	16°	3-3/8" x 2-1/4"	1125DP4CHR	1125004CHR
Deck Mt. LED	34-5/8"	16°	3-3/8" x 2-1/4"	1625DP4CHR	1625004CHR

**Fig. 1625 Wiring Note:** When choosing LED upgrades to replace existing incandescent combination masthead/all-round lights, optional Cat. No. 1680DP012V Converter Module is available to avoid re-wiring the navigation light switch.

**Fig. 1680DP012V**

Fig. 1625 L.E.D.'s have no user serviceable parts

### Spare Parts Information

**Figs. 1123, 1124 & 1125:**  
 12V Bulbs: 0071DP0CLR.  
 Cap for Base: 0125DP0BLK  
 Lenses (2 per card): 0278DP0WHT.  
 Top Cap with Screw: 1158DP0BLK.  
 Replacement Pole Size 1: 1123DP199A.  
 Replacement Pole Size 2: 1123DP299A.

Fig. 1123 Base with Socket Assembly: 1123DP099A.  
 Fig. 1124 Base with Socket Assembly: 1124DP099A.  
 Fig. 1125/1625 Base with Socket Assembly: 1125DP099A.  
 Fig. 1125 Replacement Pole Light : 1125DP499A.



## White All-Round Navigation Lights

### Adjustable Rake plus two collars = Universal Replacement Lights

Note: Retail Packaged lights are designed to fit most other manufacturers' bases.

#### Retail Packaged Fold-in-Half Pole Lights

#### 2-mile (USCG 2nm) Certified

Use on Power Driven Vessels Under 20m (65.6 ft.) in Length

**Material:** Polymer Top and Collar with Clear Fluted Lens, Frosted Top and 3/4" Aluminum Tube  
**Finish:** Black  
**Contacts:** Gold Plated  
**Voltage:** 12V LED or 12V Incandescent (Bulb Included)  
**Wattage:** Delta 9 watts    Stealth LED 1.5 watts    Omega LED 4.5 watts  
**Amperage:** .69 amps    0.1 amps    0.35amps  
**Base (2-Pin):** Locking collar fits Figs.1045, 1046, 1047, 1059, & 1060 bases  
 Threaded collar fits Fig. 1048 base

**Features:** Fold-in-Half poles allow for long poles to be stored when not in use. The adjustability of the globe allows for proper horizontal alignment regardless of base configuration.

**Retail Pkg.:** Universal replacement lights are designed to fit most other manufacturers' bases. They feature two collars (one threaded and one locking), two screw positions, and an adjustable head (wide 40°).

**Delta Series:** Incandescent Light: Reduced Glare Includes the clear, full output globe which allows for improved visibility when in rough water and from above. Delta's list of features puts it in a class by itself. No Other pole light system offers more.

**Omega Series:** LED Reduced Glare offers the same benefits as the Delta Series but in an LED version.

**Stealth Series:** LED Reduced Glare design helps preserve night vision by reducing the amount of light wasted outside of the visibility zone and not attracting as many bugs.



#### Compatible Bases (2-Pin)



Series	Approx. Pole Length	Retail Pkg.
Delta	48	1451DP6CHR
Delta	60	1451DP8CHR
Stealth LED	48	1349DP6CHR
Stealth LED	60	1349DP8CHR
Omega LED	48	1348DP6CHR
Omega LED	60	1348DP8CHR

#### Spare Parts Information



**Delta Series:**  
 Bulbs: 0338DP2CLR.  
 Black/Clear Globe: 0239DP0BLK.  
 Clear Globe: 0239DP0CLR



Bases Sold Separately - See Pages 58 & 59.

L.E.D.'s have no user serviceable parts





## White All-Round Navigation Lights - Bulk Packaged Fold-in-Half Pole Lights

### OEM Bulk Packaged Fold-in-Half Pole Lights

#### 2-mile (USCG 2nm) Certified

Use on Power Driven Vessels Under 20m (65.6 ft.) in Length

Material:	Polymer Top and Collar with Clear Fluted Lens and 3/4" Aluminum Tube			
Finish:	Black			
Contacts:	Gold Plated			
Voltage:	12V LED or 12V Incandescent (Bulb Included)			
	<u>Coastal</u>	<u>Inland</u>	<u>Stealth LED</u>	<u>Omega LED</u>
Wattage:	9 watts	9 watts	1.5 watts	4.5 watts
Amperage:	.69 amps	.69 amps	0.1 amps	0.35 amps
Base (2-Pin):	Locking collar fits Figs.1045, 1046, 1047, 1060 bases.			
Features:	Fold-in-Half poles allow for long poles to be stored when not in use.			

**OEM Bulk Pkg.:** These lights have fixed pole light heads with either 0° or 5° pole rake and single locking collar.

**Coastal Series:** Incandescent Light: Reduced Glare globe allows for improved visibility when in rough water and from above.

**Inland Series:** Incandescent Light: Reduced Glare design helps preserve night vision by reducing the amount of light wasted outside of the visibility zone and not attracting as many bugs.

**Omega Series:** LED: Reduced Glare offers the same benefits as the Coastal Series but in an LED version.

**Stealth Series:** LED: Reduced Glare offers the same benefits as the Inland Series but in an LED version.



**Fig. 1454 (Shown) Stealth Series with Locking Collar**

Series	Aprox. Pole Length	Pole Rake	OEM Bulk Pkg.
Inland	54	0°	1450007CHR
Inland	60	0°	1450008CHR
Inland	54	5°	1455007CHR
Inland	60	5°	1455008CHR
Coastal	54	0°	1452007CHR
Coastal	60	0°	1452008CHR
Coastal	54	5°	1456007CHR
Coastal	60	5°	1456008CHR
Stealth LED	54	0°	1454007CHR
Stealth LED	60	0°	1454008CHR
Stealth LED	54	5°	1459007CHR
Stealth LED	60	5°	1459008CHR
Omega LED	54	0°	1450L07CHR
Omega LED	60	0°	1450L08CHR
Omega LED	54	5°	1455L07CHR
Omega LED	60	5°	1455L08CHR

### Locking Collar Compatible Bases (2-Pin)



**Spare Parts Information**



**Delta, Coastal, & Inland Series:**  
 Bulbs: 0338DP2CLR.  
 Black/Clear Globe: 0239DP0BLK.  
 Clear Globe: 0239DP0CLR



Fig. 0239 CLR Fig. 0239 BLK Fig. 0338

**Bases Sold Separately - See Pages 58 & 59.**

L.E.D.'s have no user serviceable parts



## Specialty Lights

### Heavy Duty Pole Lights . . .

. . . are manufactured using 7/8" diameter extruded tubing. Fifteen percent larger in diameter with a 33% thicker wall than standard welded tube pole lights, these pole lights are much stronger than standard counterparts. They are an ideal choice for high speed boats, those used in rough water, or when an extra long pole is needed. The matching base & collar are machined from Marinium (a special marine grade aluminum), making this light/base combination a great looking option for high end boats.

### Heavy Duty Poles allow for . . .

- Longer length lights
- Easy to store 2-piece poles
- Stronger assemblies
- Unique light heads
- Special mounting and bend options



### LED and Incandescent Options

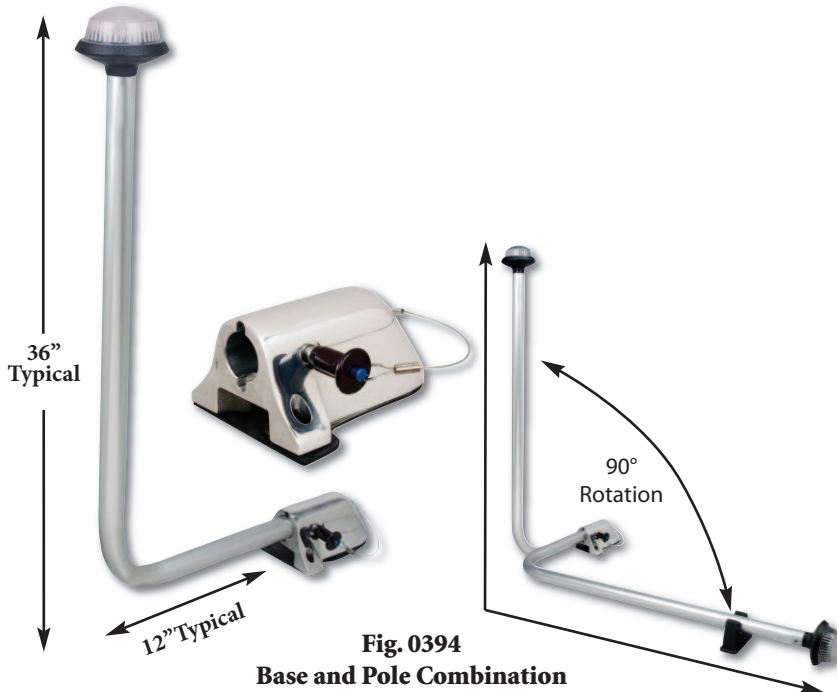

Fig. 0394  
Base and Pole Combination



## Specialty Lights

### Heavy Duty Pole Lights & Bases

#### 2-mile (USCG 2nm) Certified

Use on Power Driven Vessels Under 20m (65.6 ft.) in Length

#### Poles:

Material: Fig. 0390: Marinium Top and Clear Fresnel Globe  
 Fig. 0390L: White Polymer Top and Clear Fluted Lens  
 Fig. 0394: Black Polymer Top and Clear Fluted Lens  
**7/8" Anodized Aluminum with Marinium Collar**

#### Tube:

Rake: 0°

#### Voltage:

Fig. 0390L: 12V LED  
 Fig. 0390/0394: 12V (Bulb Included)

#### Wattage:

Fig. 0390L 4.5 watts Fig. 0390 9 watts Fig. 0394 9 watts

#### Amperage:

.35 amps .69 amps .69 amps

#### Features:

Fig. 0394 • Rotates 90° in Both Directions (Includes Fig. 0477 Pole Clip)  
 (See page 54)

#### Bases:

Material: Marinium Alloy Base & Cap with Polymer Gasket and Retainer  
 Tube: Fits 7/8" Anodized Aluminum Poles  
 Rake: 0°

#### Head and Base Options



Fig. 0390

Fig. 0390L  
LED

Fig. 0392  
Vertical Mt.

Fig. 0393  
Vertical Mt.



Fig. 0391  
Threaded Collar  
2 Pin Base

Poles Length	Light Type	OEM Bulk Pkg.
48	Bulb	0390006MAR
54	Bulb	0390007MAR
60	Bulb	0390008MAR
48	L.E.D.	0390L06MAR
54	L.E.D.	0390L07MAR
60	L.E.D.	0390L08MAR



Bases Projection	Dimensions	Screw Size	Retail Pkg.	OEM Bulk Pkg.
-----	2-3/8" O.D.	#8	0391DP0MAR	0391000MAR
2-3/16	3-1/16" x 3-3/8"	#10	-----	0392000MAR
2-3/16	3-1/16" x 4-1/2"	#10	-----	0393000MAR

Cap, Retainer, and Gasket for Fig 0391 Base: 0391DP099A.  
 Cap, Retainer, and Gasket for Fig 0392 Base: 0392DP099A.  
 Cap, Retainer, and Gasket for Fig 0393 Base: 0393DP099A.

#### Folding Pole & Base Combination (See Page 54)

Pole Length	Projection Base	Base Dimensions	Screw Size	OEM Bulk Pkg.
36	2-3/16"	3-1/16" x 4-1/2"	#10	0394000MAR



Fig. 0390L  
Pole  
(Shown)



## Custom Light Manufacturing

### Customization Options:

- Special lengths
- Custom bends
- Unique pole diameters, materials, & finishes
- Two piece poles
- Color matching
- Popular quick disconnect terminations
- Non standard light base and head combinations

2

Navigation Lights

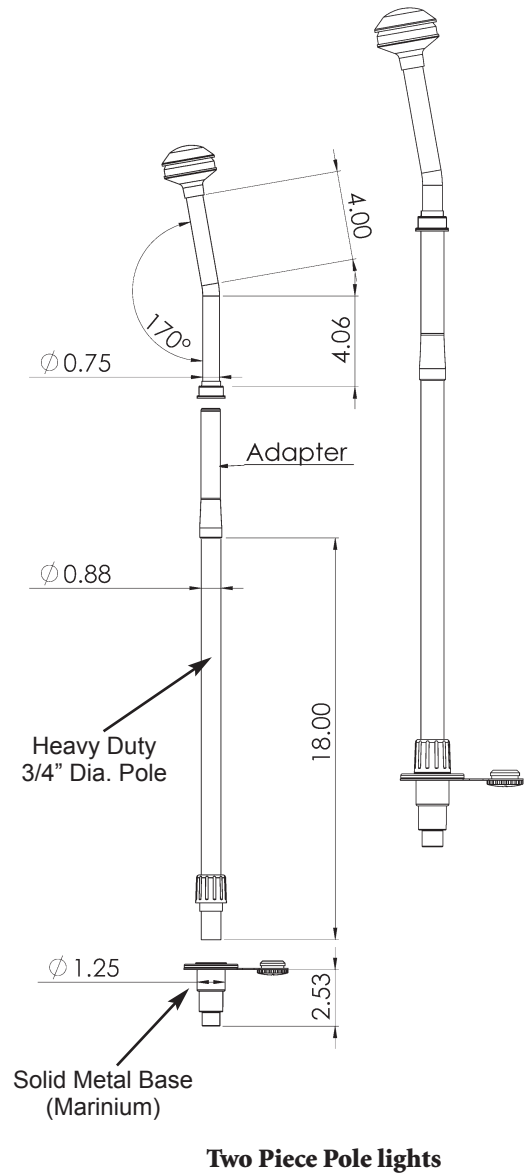
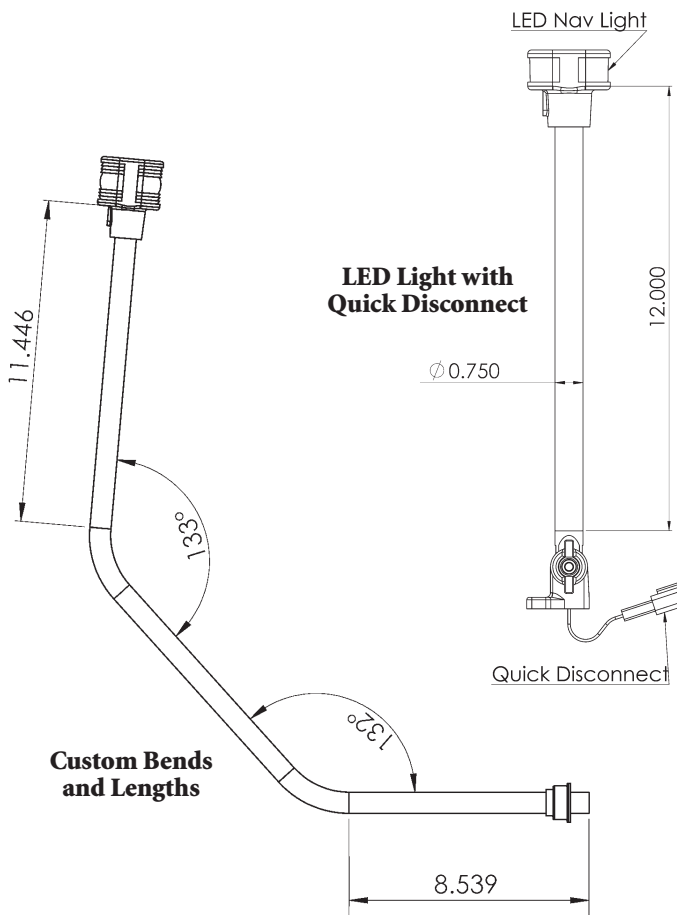

### HEAD OPTIONS



### BASE OPTIONS



### TERMINATION OPTIONS

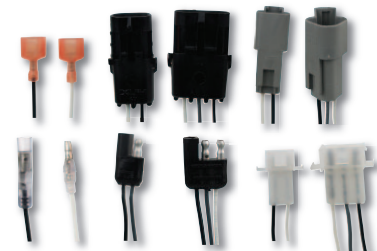

Consult the factory for quick quotes and custom pole light samples.

## Mini-Mount Plug-In Bases

### Mini-Mount Plug-In Base (2 Pin and 3 Pin)

Material: Polymer with Optional Brass Insert  
 Finish: Black or Black with Chrome Plated Insert  
 Dimensions: 1-15/16" O.D.  
 Contacts: Gold Plated  
 Uses: Small Threaded Collar  
 Fits Perko Poles: Figs. 1614 and 1619 Bi-Color Pole Lights  
 Figs. 1401, 1441, 1441L, 1443,  
 and 1461 All Round Lights  
 For use with: 3/4" diameter poles, 0° Angle

- Features:
- No mounting hardware required
  - Installs with threaded nut from under the mounting surface.
  - Waterproof Snap-On Cover
  - Pigtail Leads
  - Tool available



**Fig. 1049 Base**  
Black



**Fig. 1441 (Shown)**  
Small Threaded Collar  
0° Rake

Can be assembled with any PERKO® pole light head and the small threaded collar



Mini-Mount base shown with tool (1049ITL99A) for easy installation

See Perko website for detailed pole light ordering information

Finish	Number of Pins	Retail Pkg.	OEM Bulk Pkg.
Black	2	1049P00DPB	1049P00BLK
Chrome/Black	2	1049P00DPC	1049P00CHR
Black	3	10493B0DPB	10493B0BLK
Chrome/Black	3	10493B0DPC	10493B0CHR



**Fig. 1049**  
Chrome/Black

**Fig. 1049**  
Black

**Note: Base Requires Access from Underneath for Installation and Service**

**Fig. 1049 Spare Parts Ordering Information**  
 Black Cap for Base: 1049DPB99A  
 Black Cap with Chrome Brass Insert for Base: 1049DPC99A  
 Installation Tool: 1049ITL99A



## Pole Light Mounting Bases

### Fig. 1045

Material: Brass or Stainless Steel Ring, Polymer Base  
 Finish: Chrome Plated or Polished  
 Rake: 0°  
 Pins: 2 or 3 Pin  
 Contacts: Gold Plated  
 Collar: Fits 3/4" Poles with Locking Collar  
 Features: Waterproof Snap-On Cover & Pigtail Leads



Locking Collar



Fig. 1045  
0° Rake

### Figs. 1046 & 1047

Material: Brass or Stainless Steel Ring, Polymer Base  
 Finish: Chrome Plated or Polished  
 Contacts: Gold Plated  
 Rake: 0° or 5°  
 Pins: 2 or 3 Pin  
 Collar: Fits 3/4" Poles with Locking Collar  
 Features: Water Resistant Slide Cover & Pigtail Leads



Locking Collar



Fig. 1047  
0° Rake



Fig. 1046  
5° Rake

### Figs. 1059 & 1060

Material: Zinc Alloy and Polymer Base  
 Finish: Chrome Plated & Black  
 Contacts: Gold Plated  
 Rake: 5° or 16°  
 Pins: 2 or 3 Pin  
 Collar: Fits 3/4" Poles with Locking Collar  
 Features: Waterproof Snap-On Cover & Pigtail Leads



Locking Collar



Fig. 1059  
16° Rake



Fig. 1060  
5° Rake

### Fig. 1048

Material: Brass or Stainless Steel, Polymer Base  
 Finish: Chrome Plated or Polished with Black Base  
 Contacts: Gold Plated  
 Rake: 5°  
 Collar: Fits 3/4" Poles with Threaded Collar  
 Features: Waterproof Snap-On Cover & Pigtail Leads



Threaded Collar



Fig. 1048  
5° Rake

### Fig. 0391 - Heavy Duty Base

Material: Marinium Alloy Base & Cap with Polymer Gasket and Retainer  
 Finish: Polished  
 Contacts: Gold Plated  
 Rake: 0°  
 Collar: Fits 7/8" Poles with Threaded Collar  
 Features: Waterproof Threaded Cover & Pigtail Leads

Fig. 0391



### Figs. 1123 & 1124

Material: Zinc Alloy and Polymer Base  
 Finish: Chrome Plated & Black  
 Contacts: Gold Plated  
 Rake: 45°  
 Pins: 3 Pin  
 Collar: Fits 3/4" Poles with 1123 Threaded Collar  
 Features: Waterproof Screw On Cover for Base & Adapters for "V" or Flat Mounting



Screw On Collar



Fig. 1123-99A



Fig. 1124-99A

All Bases use Screw Size: #8

# Pole Light Mounting Bases

## Pole Light Mounting Base Compatibility Chart

<b>Fig. 1045 (2 Pin) 0° Rake Fits Figs.</b>	<b>Fig. 1046 (2 Pin) 5° Rake Fits Figs.</b>	<b>Fig. 1047 (2 Pin) 0° Rake Fits Figs.</b>	<b>Fig. 1059 (2 Pin) 16° Rake Fits Figs.</b>	<b>Fig. 1060 (2 Pin) 5° Rake Fits Figs.</b>	<b>Fig. 1048 (2 Pin) 5° Rake Fits Figs.</b>	<b>Fig. 1123 2 Pin option available. Contact the factory for more information.</b>	<b>Fig. 1124 2 Pin option available. Contact the factory for more information.</b>	<b>Fig. 0390 (2 Pin) 0° Rake Fits Figs.</b>
1343 1450 1347 1451 1348 1452 1349 1460 1400 1454 1404 1470 1440 1612 1440L 1616 1442	1343 1447 1347 1451 1348 1455 1349 1456 1400 1465 1404 1470	1343 1442 1347 1450 1348 1451 1349 1452 1400 1454 1404 1460 1440 1470 1440L 1616	1330 1343 1347 1348 1349 1400 1404 1451 1470	1343 1451 1347 1455 1348 1456 1349 1465 1400 1470 1404 1445 1447	1343 1445L 1347 1470 1348 1622 1349 1624 1451 1656 1400 1403			0390 0390L
<b>Fig. 1045 (3 Pin) Fits Figs.</b>		<b>Fig. 1047 (3 Pin) Fits Figs.</b>		<b>Fig. 1060 (3 Pin) Fits Figs.</b>		<b>Fig. 1123 (3 Pin) Horiz. Mt. Fits Figs.</b>	<b>Fig. 1124 (3 Pin) Vert. Mt. Fits Figs.</b>	
1211 1421		1211 1421		1212 1422		1123	1124	
2-1/4" O.D.	3-1/2"x1-1/2"	3-1/2"x1-1/2"	3-3/4"x1-5/8"	3-3/4"x1-3/4"	3-1/2"x 2"	2-1/4" x 3/4"	3/4" x 2-1/4"	2-3/4" O.D.

## Pole Light Mounting Base Ordering Information

Finish	Collar Type	Number of Pins	Tube Angle Degrees	Retail Pkg.	OEM Bulk Pkg.
<b>2 Pin Bases</b>					
Chrome	Locking	2	0	1045P00DP	1045P00CHR
Polished SS	Locking	2	0	1045P0SDP	1045P00STS
Chrome	Locking	2	5	1046P00DP	1046P00CHR
Polished SS	Locking	2	5	1046P0SDP	1046P00STS
Chrome	Locking	2	0	1047P00DP	1047P00CHR
Polished SS	Locking	2	0	1047P0SDP	1047P00STS
Chrome	Locking	2	16	1059P00DP	1059P00CHR
Chrome	Locking	2	5	1060PB0DP	1060PB0CHR
Chrome	Threaded	2	5	1048P00DP	1048P00CHR
Polished SS	Threaded	2	5	1048P0SDP	1048P00STS
Marinium	Threaded	2	0	0391DPOMAR	0391000MAR
<b>3 Pin Bases</b>					
Chrome	Locking	3	0	1045300DP	1045300CHR
Polished SS	Locking	3	0	104530SDP	1045300STS
Chrome	Locking	3	0	10473B0DP	10473B0CHR
Polished SS	Locking	3	0	10473BSDP	10473B0STS
Chrome	Locking	3	5	10603B0DP	10603B0CHR
Chrome	Threaded	3	45	1123DP099A	-----
Chrome	Threaded	3	45	1124DP099A	-----



## Spare Lenses For Navigation Lights For Vessels Under 20 Meters (65.6 ft.)

### 112-1/2° Lenses for Bi-Color/Tri-Color Lights

Color	Height	Width	Retail Pkg.
Red/Green	1-5/16"	2-1/8"	0247DP0LNS*
Red/Green	1"	1-3/4"	0283DPALNS*
Red/Green	1-1/4"	1-3/8"	0296DP0LNS*
Red/Green	1-1/4"	2-3/16" O.D.	0297DP0LNS*
Red/Green	2-1/2"	2"	0259DPALNS
Red/Green	1-1/2"	1"	0268DP0LNS
Red/Green	7/8"	1-5/8" x 13/16"	0227DP0LNS*
Red/Green	1-1/8"	3" x 1-5/8"	0241DP0LNS*
Red/Green	1-1/2"	2-3/8"	0229DP0LNS*



\*One Piece Lens

### 112-1/2° Lenses for Side Lights

Color	Height	Width	Retail Pkg.
Red	1-5/16"	2-1/8"	0273DPRLNS
Green	1-5/16"	2-1/8"	0273DPGLNS
Red	1-3/4"	1-1/16"	0277DPRLNS
Green	1-3/4"	1-1/16"	0277DPGLNS
Red	1"	1-3/4"	0298DPRLNS
Green	1"	1-3/4"	0298DPGLNS
Red	7/8"	1-5/8"	0228DPRLNS
Green	7/8"	1-5/8"	0228DPGLNS
Red	1-1/2"	2-3/8"	0232DPRLNS
Green	1-1/2"	2-3/8"	0232DPGLNS
Red/Green	1"	1-9/16"	0281DPALNS*
Red/Green	1"	2-1/8"	0295DP0LNS*
Red/Green	1-1/4"	----	0260DP0LNS*



\*Set of 1 Red and 1 Green Lens

### 225° Lenses for Masthead Lights

Color	Height	I.D.	O.D.	Retail Pkg.
Clear	1"	1-9/16"	2-3/16"	0281DPAWHT
Clear	1-1/2"	1"	1-1/4"	0278DPOWHT*
Clear	1-1/2"	1"	2-1/8"	0295DPOWHT



\*2 Pcs. per card

### 135° Lenses for Stern Lights

Color	Height	I.D.	O.D.	Retail Pkg.
Clear	1-1/4"	1-9/16"	2-3/16"	0074DPOWHT
Clear	1-1/2"	1"	1-1/4"	0278DPOWHT*
Clear	1-1/4"	1-9/16"	2-3/16"	0281DPAWHT
Clear	----	----	2"	0284DPOCLR**
Clear	----	----	2-1/8"	0295DPOWHT



\*2 Pcs. per card \*\*Includes O-Ring

### 360° Lenses for All-Round Lights

Color	Height	I.D.	O.D.	Retail Pkg.
White	3"	1-1/2"	1-9/16"	0201DPOWHT
Clear	2-1/2"	1-11/16"	2"	0248DPOCLR
Frosted	2-1/2"	1-11/16"	2"	0248000FRD*
Clear	3-5/16"	3-3/16"	----	0261JROCLR*
Black/Clear	2"	----	2-1/4"	0238DPOBLK
Black/Clear	2"	----	2-1/4"	0239DPOBLK
Clear	2"	----	2-1/4"	0239DPOCLR
Black/Clear	1-1/8"	----	3" x 1-5/8"	0240DP0LNS



\*0248000FRD 5 per box, 0261JROCLR 1 per box

## Bulbs for Navigation Lights - Ordering & Technical Information

For Vessels Under 20 Meters (65.6 ft.) in Length

### Double Contact Bayonet Base Bulb

Nominal Voltage	Wattage	Amps	Retail Pkg.	Bulbs per Card	Bulb Diameter	Mfr. Lamp. No.
12	7	.58	0337011DP	2	3/4"	90
12	11	.94	0337012DP	2	3/4"	1004
24	15	.63	0337014DP	1	1"	306



Fig. 0337

### Double Contact Bayonet Base Bulb

Clear Type T-8, C-8, Filament - 1-3/8 Inch L.C.L.

Nominal Voltage	Wattage	Amps	Standard Pkg.
12	30	2.5	0374001CLR
24	30	1.3	0374002CLR
120	30	.25	0374004CLR



Fig. 0374

### Double Contact Bayonet Indexing Base Bulb

Nominal Voltage	Wattage	Amps	Standard Pkg.
12	10	.83	037512V10W
12	25	2.08	037512V25W
24	10	.42	037524V10W
24	25	1.04	037524V25W



Fig. 0375

### Wedge Base Bulb

Nominal Voltage	Wattage	Amps	Retail Pkg.	Bulb Dia.	Bulb Length
12	5	.35	0338DP1CLR	13/32"	1-1/16"
12	9	.69	0338DP2CLR	5/8"	1-1/2"



Fig. 0338 #2



Fig. 0338 #1

### Festoon Bulbs - Double Ended

Nominal Voltage	Wattage	Amps	Retail Pkg.	Bulb Dia.	Bulb Length
12	8	.70	0071DP8CLR	3/8"	1-1/8"
12	10	.83	0069DP0CLR	3/8"	1-5/8"
12	10	.74	0070DP0CLR	3/8"	1-11/16"
12	15	.97	0070DP1CLR	9/16"	1-11/16"
12	10	.80	0071DP0CLR	3/8"	1-1/8"
24	8	.35	0072DP8CLR	3/8"	1-1/8"
24	10	.42	0067DP1CLR	3/8"	1-11/16"
24	18	.75	0067DP2CLR	9/16"	1-11/16"
24	10	.40	0072DP1CLR	3/8"	1-1/8"



3/8" Dia.



9/16" Dia.

Fig. 0067

Fig. 0069

Fig. 0070

Fig. 0071

Fig. 0072



**Note: Bulbs MUST BE ORDERED in Standard or Dealer Package Quantities Only!**  
 Bulbs for Utility Lights, See Page 69. Bulbs for Navigation Lights Over 20m, See Commercial Catalog 315-C, Page C-35.  
 For bulbs for 32V Lights: Contact the Factory.

## Replacement Collars and Glare Shield for Plug-In Pole Lights

2

Navigation Lights

### Replacement Collar Set

The Collar Set Provides Collars to Fit All of PERKO's Plug-in Pole Lights

- Material: Black Polymer
- Finish: Black
- Contains: 1 each Locking, Large Threaded, Small Threaded, and Screw on Collars
- For use with: 3/4" diameter poles



Locking Collar



Threaded Collar



Sm. Threaded Collar



Screw On Collar



Fig. 0030DP0002  
4 Collar Set

**Description**  
4 Collar Set

**Retail Pkg.**  
0030DP0002

### Glare Shield

Can Be Installed without Removing Light

- Material: Black Polymer
- Finish: Black
- Dimensions: 6" x 4-5/16"
- For Use With: 3/4 Inch O.D. Tubing

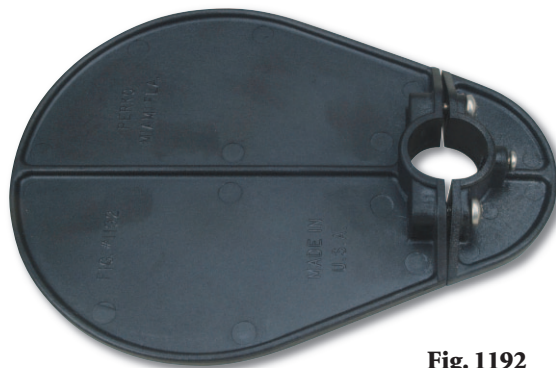

Fig. 1192



Shown Installed

**Retail Pkg.**  
1192DP0BLK

**OEM Bulk Pkg.**  
1192000BLK



## LED Utility Lights

### LED Utility Lights

Material: Brass Frame  
 Finish: Chrome Plated  
 Dimensions: 7-1/4" x 1-1/2"  
 Installs In: 2-1/8" Diameter Hole  
 Screw Size: #6  
 Voltage: 12V LED  
 Wattage: 4 watt  
 Amperage: 0.31 amps  
 Features: Lab Rated LED Life 50,000 hours

**Fig 0606:** All white LED utility light

**Fig 0607:** White/Red LED utility light to preserve nighttime vision



**Fig. 0606 - White**



**Fig. 0607 - with Red On**



**Fig. 0607 - with White On**

LED Color	Retail Pkg.	OEM Bulk Pkg.
White	0606DP0CHR	0606000CHR
White/Red	0607DP0CHR	0607000CHR



### Surface Mount Utility Lights

Material: Molded Polymer  
 Finish: Black or White  
 Dimensions: Length Overall: 1-7/8", Width: 9/16"  
 Screw Size: #6  
 Voltage: Fig 0137/0140      Fig. 0145  
                   12V (Bulb Included)    12V LED  
 Wattage: 1 watt                      .25 watts  
 Amperage: .08 amps                0.02 amps  
 Features: **Figs. 0137/0140:** Diffused Light Cover  
                   **Fig. 0145:** LED with Shielded Light Cover



**Fig. 0145**



**Fig. 0137**



**Fig. 0140**

Voltage	Dealer Pkg.	OEM Bulk Pkg.
12V	0137DP0BLK	0137000BLK
12V	0140DP0NYN	0140000NYN
12V L.E.D.	0145DP0NYN	0145000NYN



### LED Louvered Cockpit Utility Light

Looks like a vent but functions as a courtesy light

Material: Stainless Steel & Black Polymer  
 Finish: Polished  
 Dimensions: Width: 3-1/8", Height: 1-5/8"  
 Screw Size: #8  
 Voltage: 12V LED (Supplied with 6" pig tail wire leads)  
 Wattage: .25 watts  
 Amperage: 0.02 amps  
 Features: Uses less than half the energy draw of standard lights.



**Fig. 1033**

Finish	Retail Pkg.	OEM Bulk Pkg.
Polished SS	1033DP1STS	1033001STS

## Cockpit Utility Lights

### Reduced Glare Clear Back Utility Light

The clear back allows light to shine both inside and outside of the mounting location

- Material: Brass or Stainless Steel with Clear Polymer Back  
 Finish: Chrome Plated or Polished  
 Dimensions: O.D.: 3", Depth: 1"  
 Installs In: 2-1/8" Diameter Hole  
 Screw Size: #8  
 Voltage: 12V (Bulb included), 24V with bulb change  
 Wattage: 10 watts  
 Amperage: .83 amps  
 Features:
- Directs 80% of the light downward, thus reducing cockpit glare.
  - Ideal for mounting on center consoles, storage lockers, cabinets, and electronics boxes.



Fig. 1149

Finish	Retail Pkg.	OEM Bulk Pkg.
Chrome	1149DP112V	114900112V
Polished SS	1149DP1STS	1149001STS

Diagram of center console mt.

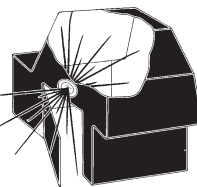

### Reduced Glare Design Cockpit Light

Directs 80% of the Light Downward, Thus Reducing Cockpit Glare

- Material: Brass, Stainless Steel, or Polymer with Polymer Base  
 Finish: Chrome Plated, Polished, or White  
 Dimensions: O.D.: 3", Depth: 1"  
 Installs In: 2-1/8" Diameter Hole  
 Screw Size: #8  
 Voltage: 12V (Bulb included), 24V with bulb change  
 Wattage: 10 watts  
 Amperage: .74 amps



Fig. 1146 Chrome

Finish	Voltage	Retail Pkg.	OEM Bulk Pkg.
Chrome	12	1146DP112V	114600112V
Chrome	24	1146DP224V	114600224V
Polished SS	12	1146DP1STS	1146001STS
Polished SS	24	1146DP2STS	1146002STS
White	12	1146DP1WHT	1146001WHT
White	24	1146DP2WHT	1146002WHT



Stainless



White



### Low Profile LED Ceiling Mount Utility Lights

- Material: Brass, Stainless Steel, or White PERKO-Kote with Polymer Base  
 Finish: Chrome Plated, Polished, or White  
 Dimensions: O.D.: 3"  
 Installs In: 2-1/8" Diameter Hole  
 Screw Size: #8  
 Voltage: 12V LED  
 Wattage: 4.5 watts  
 Amperage: 0.3 amps  
 Features: Uses less than half the energy draw of standard lights.



Fig. 1156 Chrome

Finish	Retail Pkg.	OEM Bulk Pkg.
Chrome	1156DP112V	115600112V
Polished SS	1156DP1STS	1156001STS
White	1156DP1WHT	1156001WHT

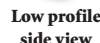

Low profile side view



**Fig. 1149:**

Socket Assy: 114900099B.  
 Lens w/Gasket: 1146DP099A.  
 Mounting Flange: 094600099C

**Fig. 1146:**

Socket Assy: 114600099B.  
 Lens w/Gasket: 1146DP099A.  
 Mounting Flange: 094600099C

**Spare Parts Information**



**Fig. 1146 & 1149 Bulbs:**

12 Volt Bulbs: 0070DP0CLR.  
 24 Volt Bulbs: 0067DP1CLR.

## Utility Lights

### Flush Mount Utility Lights with Snap on Front Cover

- Material: Polymer  
 Finish: Black or White  
 Dimensions: 2-1/4" x 2-1/4", Depth: 15/16"  
 Installs In: 1-3/4" Diameter Hole  
 Screw Size: #6  
 Voltage: Fig. 1044                      Fig. 1074  
                   12V (Bulb included)    12V LED  
 Wattage:        3 watts                                .25 watts  
 Amperage:      .23 amps                                    0.02 amps  
 Features:
- Concealed mounting screws
  - Easy to install
  - Flush mounting
  - Diffusion lens



**Fig. 1044**  
Black



**Fig. 1074**  
LED White

- Style No. 1: Supplied with 1/4" Spade Connectors (Fig. 1044 only)  
 Style No. 2: Supplied with 7" Pig Tail Wire Leads

Color	Style	Connection	Retail Pkg.	OEM Bulk Pkg.
Black	1	Spade	1044DP1BLK	1044001BLK
Black	2	Pig Tail	1044DP2BLK	1044002BLK
White	1	Spade	1044DP1WHT	1044001WHT
White	2	Pig Tail	1044DP2WHT	1044002WHT
Black	LED 2	Pig Tail	1074DP2BLK	1074002BLK
White	LED 2	Pig Tail	1074DP2WHT	1074002WHT

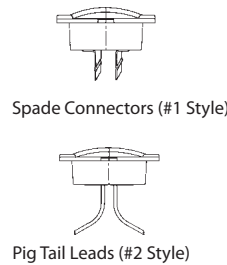

LED



Incandescent



### Adjustable Utility Light

- Material: Zinc Alloy  
 Finish: Chrome Plated  
 Dimensions: O.D. Overall: 2-5/8", Length Neck: 3/4", O.D. Neck: 7/8"  
 Installs In: 1" Diameter Hole  
 Screw Size: #6  
 Voltage: 12V (Bulb Included)  
 Wattage: 7 watt  
                   .58 amps  
 Features: Shield swivels to change light direction



**Fig. 1254**

Type	Dealer Pkg.
Incandescent	1254DP0CHR



#### Spare Parts Ordering Information

**Fig. 1044**  
Bulbs: 1044DP099A.

**Fig. 1254:**  
Bulbs: 0337011DP.  
Socket: 0024DP1.



## Surface Mount Lights

### Surface Mount Dome Lights

Material: Zinc Alloy, Clear Polymer Lens with Black Vinyl Mounting Gasket  
 Finish: Fig. 0300: Chrome Plated  
 Dimensions: See Below  
 Screw Size: Size 0 & 1: #10 R.H., Size 2: #12 R.H.  
 Voltage: 12V (Bulb included)  
 Features: Push Switch with Water Resistant Boot



Fig. 0300

O.D. Base Dimensions	Lens Size	Depth Overall	Wattage Supplied	Bulb Supplied	Amps	Max. Wattage	Retail Pkg.	OEM Bulk Pkg.
3-3/4"	3"	1-1/2"	7		.58	11	0300DP0CHR	0300000CHR
5"	4"	1-7/8"	11		.94	17	0300DP1CHR	0300001CHR
6"	5"	2"	17		1.44	17	0300DP2CHR	0300002CHR



### Surface Mount Dome Lights

Material: Zinc Alloy, Clear Polymer Lens with Black Vinyl Mounting Gasket  
 Fig. 1253: Ivory PERKO-KOTE  
 Dimensions: See Below  
 Screw Size: Size 1: #10 R.H., Size 2: #12 R.H.  
 Voltage: 12V (Bulb included)  
 Features: Push Switch with Water Resistant Boot



Fig. 1253

O.D. Base Dimensions	Lens Size	Depth Overall	Wattage Supplied	Bulb Supplied	Amps	Max. Wattage	Retail Pkg.	OEM Bulk Pkg.
5"	4"	1-7/8"	11		.94	17	1253DP1WHT	1253001WHT
6"	5"	2"	17		1.44	17	1253DP2WHT	1253002WHT



### Push Button Switch

Material: Black Polymer with Weather Resistant Cover  
 Voltage: Rated for 10 Amps at 12, 24 and 32 Volts  
 Features: Push-On, Push-Off



Fig. 0701



Max. Thickness of Panel	Diameter Neck	Retail Pkg.
1/8"	3/8"	0701DP

### Spare Parts Information



Fig. 0337

**Figs. 0300 & 1253**  
 Bulbs for Size #0: 0337011DP.      Switch: 0701DP.  
 Bulbs for Size #1: 0337012DP.      Socket: 0024DP1.  
 Bulbs for Size #2: 0337013DP.      Lens: 0257DP, Specify Size; 3", 4" or 5"  
 NOTE: To use in a 24 volt system, order replacement bulb : 0337014DP.

## Surface Mount Lights



### Dimmer Capable LED Surface Mount Dome Light

Material: Zinc Alloy and Clear Polymer Lens  
 Finish: Chrome Plated or White PERKO•KOTE  
 Dimensions: O.D.: 3-5/8", Depth: 1"  
 Screw Size: #8 R.H.  
 Voltage: 12 Volt LED or 24 Volt LED  
 Wattage: 8 watts                      3 watts  
 Amperage: 0.66 amps                0.12 amps  
 Features: On/Off Switch



Fig. 1356

Chrome

White

Finish	Voltage	Retail Pkg.	OEM Bulk Pkg.
Chrome	12V	1356DP0CHR	1356000CHR
Chrome	24V	1356DP2CHR	1356002CHR
White	12V	1356DP0WHT	1356000WHT
White	24V	1356DP2WHT	1356002WHT

Please contact the factory for availability of devices for applications that require a Multiple Light Wall Dimmer Switch for Fig. 1356.



### Surface Mount Dome Lights with Red and White Bulbs

Material: Zinc Alloy, Clear Lens  
 Finish: Ivory PERKO•KOTE  
 Dimensions: O.D. Lens: 4"  
 Screw Size: #10 R.H.  
 Voltage: 12V (Bulbs Included)  
 Features:
 

- Three Position Toggle Switch (Red-Off-White)
- Red light helps preserve night vision



Fig. 1263

O.D. Base Dimensions	Depth Overall	Wattage Bulb Supplied	Amps	Max. Wattage	Retail Pkg.	OEM Bulk Pkg.
5"	1-7/8"	7	.94	18	1263DP1WHT	1263001WHT



### Bulkhead Light Fixture

Material: Zinc Alloy  
 Finish: Chrome Plated  
 Dimensions: Base: 2-1/2" x 1-3/4", Projection: 2-5/8"  
 Screw Size: #6 R.H.  
 Voltage: For Systems up to 50 Volts (Bulb not Included)  
 Features: Medium Screw Socket and Turn Switch



Fig. 0217

Finish	Retail Pkg.
Chrome	0217DP0CHR

### Spare Parts Information



Fig. 0337

**Fig. 1263:**  
 Clear Bulbs: 0337012DP    Three Position Toggle Switch: 1263DP099A  
 Red Bulbs: 0337R12DP    Socket: 0024DP1  
 Lens: 0257DP4

**Fig. 0217:**  
 Bulb Socket Assembly with Switch and Knob: 0223.  
 Order Perko Bulb 0340, See Page 69.

## Surface Mount Lights

### Dome Light with Toggle Switch

- Material: Bronze with Clear Glass Lens  
 Finish: Chrome Plated  
 Dimensions: O.D. Lens: 6", O.D. Base: 7-7/8", Depth: 3-1/8"  
 Screw Size: #8  
 Voltage: Incandescent: For up to 50 volt systems (Bulbs Not Included)  
 LED: 12V AC/DC
- Features: **Incandescent Version:**
- Twin Double Contact Bayonet Sockets
  - Will Accommodate Two Bulbs up to 20 Watts Each



Fig. 0555



Light Type	Standard Pkg.	Voltage
Incandescent	0555000CHR	Up to 50 Volts
LED	0555L00CHR	12V

### Dome Light with Toggle Switch

- Material: Wrought Brass with Frosted Glass Lens  
 Finish: Chrome Plated  
 Dimensions: O.D. Glass: 8", O.D. Base: 9-1/2", Depth: 4"  
 Screw Size: #10 R.H.  
 Voltage: Incandescent: For up to 50 volt systems (Bulbs Not Included)  
 LED: 12V AC/DC
- Features: **Incandescent Version:**
- Medium Screw Socket
  - Size No. 1 Has One Socket and Switch. Will Accommodate One Bulb Up To 50 Watts
  - Size No. 2 Has Two Sockets and Switches. Will Accommodate Two Bulbs Up To 25 Watts Each



Fig. 0753



Light Type	Standard Pkg.	Bulbs	Voltage
Incandescent	0753001CHR	1	Up to 50 Volts
Incandescent	0753002CHR	2	Up to 50 Volts
LED	0753L01CHR	LED	12V

### Meal and Absent Light

- Material: Bronze with Blue & White Glass Globes  
 Finish: Chrome Plated  
 Dimensions: O.D. Globe: 2-1/2", Length: 9", Base: 3-3/8" x 1-3/4"  
 Screw Size: #8  
 Voltage: 12V (Bulb Not Included)  
 Wattage: 7 watts  
 Amperage: .58 amps
- Features:
- Double Contact Bayonet Sockets
  - Blue Owner Absent Light and White Mealtime Light
  - Replaces Blue and White Flags for Use at Night
  - For Mounting on Main Starboard Yardarm



Fig. 0329



Light Type	Standard Pkg.
Meal & Absent	0329000CHR

**Figs. 0555:**  
 Bulb: Fig. 0337  
 Switch: 0514DP.  
 Lens: 0257DP6.  
 Socket: 0276000.

**Fig. 0753:**  
 Bulb: Fig. 0340, Switch, Cat. No. 0514DP.  
 Socket: 1323.  
 Flat Lens For Newer 0753 Style (4" Depth): 0132FLTFRD.  
 Curved Lens For Older 0753 Style (3" Depth): 0132CVDFRD.

#### Spare Parts Information



Fig. 0337 Fig. 0340

**Fig. 0329:**  
 Required Bulbs For 12 Volt: 0337011DP.  
 For 32 Volt Applications use ANSI 624 Bulb  
 Globes: Blue: 0250000BLU. White: 0250000WHT.  
 Socket: 0024DP1.

For Figs 0555 & 0753 Bulbs, refer to Page 69 for Bulb Selection.

## Spare Bulbs for Utility Lights

**Note: Bulbs Must Be Ordered in Standard or Retail Package Quantities Only!**

Bulbs for Navigation Lights Recreation Cat. 320 Page 61 and Commercial Cat. 315-C Page C-39

### Double Contact Bayonet Base Bulbs - Clear

Nominal Voltage	Wattage	Amps	Retail Pkg.	Bulbs per Card	Bulb Diameter Inches	Mfr. Lamp No.
12	7	.58	0337011DP	2	3/4	90
12	11	.94	0337012DP	2	3/4	1004
12	18	1.53	0337R12DP*	2	1	1142R
12	17	1.44	0337013DP	2	1	1142
24	15	.63	0337014DP	1	1	306
120	15	---	0337023DP	2	7/8	15T7

\* Red Bulb



Fig. 0337

### Festoon Bulbs - Double Ended Clear with Nickel Plated Brass

Nominal Voltage	Wattage	Amps	Retail Pkg.	Bulb Dia. Inches	Bulb Length Inches
12	10	.74	0070DP0CLR	3/8	1-11/16
12	15	.97	0070DP1CLR	9/16	1-11/16
24	10	.42	0067DP1CLR	3/8	1-11/16



Fig. 0067  
Fig. 0070

**PROP 65 WARNING**  
(Contains Lead)

### Medium Screw Bulbs

Nominal Voltage	Wattage	Amps	OEM Bulk Pkg.	Type	L.C.L. Inches	Mfg. Lamp No.
12	15	1.25	0340005FRD	A-17	2-3/8	15-A
12	25	2.08	0340006FRD	A-19	2-9/16	25-A
12	50	4.16	0340007FRD	A-21	3-7/16	50-A21
32	15	.47	0340011FRD	A-17	2-3/8	15-A
32	25	.78	0340012FRD*	A-19	2-9/16	25-A
32	50	1.56	0340013FRD*	A-21	3-7/16	50-A21



Fig. 0340

**Note: For High Power Bulbs and Sealed Beam Units for Searchlights, See website.  
Electric Bulbs Are Not Returnable. Order Carefully.**

## Searchlights

### XR Series Xenon Searchlights 15 Inch 500 Watt and 19 Inch 1600 Watt

Fig. 9304

Remote  
Distant Electric  
Control Base



Fig. 9854



### Solar-Ray® 19" Searchlight Options with either Wheel, Lever/Gear or Remote Electric Controls

1900 Series  
Wheel or Lever/Gear  
Control



For more Information on the XR Series and SolarRay® Series Searchlights  
See Perko's Website: [www.perko.com](http://www.perko.com), Commercial Catalog 315-C, or Contact the Factory.



## Searchlights

### Solar-Ray® Searchlights 10", 12" or 14" Diameter



**Fig. 0883 Series  
Deck Control**

**Fig. 0885 Series  
Wheel or Lever/Gear  
Control**



**Fig. 0884 Series  
Lever Control**



**Fig. 0314  
Pilot House Control  
Searchlight  
7" or 8" Diameter**



**Fig. 0887  
14" With Remote  
Distant Electric  
Control Base**

**Fig. 0305  
For Lever  
Control**



**Sealed Beam Solar-Ray®  
8" Diameter Searchlights**

**Fig. 0313  
For Wheel or  
Lever/Gear  
Control**

For more information on the XR Series and SolarRay® Series Searchlights  
See Perko's Website: [www.perko.com](http://www.perko.com), Commercial Catalog 315-C, or Contact the Factory.

## Removable Fog Bells

The 8 and 12 Inch Bells Listed on This Page Have Been Reviewed by the U.S. Coast Guard and Comply with C.G. 169 Regulations for Sound Signal Appliances as Required by Annex III Paragraph 2 of the '72 Colregs. The 8 Inch Size is for Use on Vessels Under 20 Meters (65.6 ft.) in Length. The 12 Inch Size is for Use on Vessels of any Length.

### Heavy Weight

Material: Cast Bronze  
 Finish: Plain, Polished, or Chrome Plated  
 Dimensions: 8" or 12" Bell Bottom  
 Screw Size: 1/4" F.H.

Finish	Bottom Diameter	Height Overall	Standard Pkg.
Plain	8"	8"	0150008PLB
Polished	8"	8"	0150008POL
Chrome Plated	8"	8"	0150008CHR
Plain	12"	12"	0150012PLB
Polished	12"	12"	0150012POL
Chrome Plated	12"	12"	0150012CHR

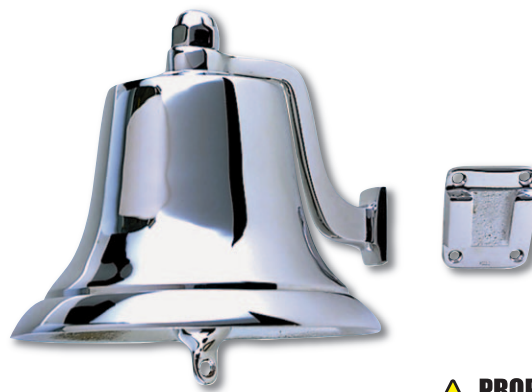

Fig. 0150 Chrome

**PROP 65 WARNING**  
(Contains Lead)

### Medium Weight

Material: Cast Bronze  
 Finish: Chrome Plated or Polished  
 Dimensions: 6" Bell Bottom  
 Screw Size: #8 F.H.

Finish	Bottom Diameter	Height Overall	Standard Pkg.
Polished	6"	5"	0420006POL
Chrome Plated	6"	5"	0420006CHR



Fig. 0420 Polished



Fig. 0420 Chrome

**PROP 65 WARNING**  
(Contains Lead)

### Light Weight

Material: Stamped Brass  
 Finish: Plain or Chrome Plated  
 Dimensions: 6" or 8" Bell Bottom  
 Screw Size: #4 F.H.

Finish	Bottom Diameter	Height Overall	Retail Pkg.
Plain	6"	4"	0159DP6PLB
Chrome Plated	6"	4"	0159DP6CHR
Plain	8"	5"	0159DP8PLB
Chrome Plated	8"	5"	0159DP8CHR



Fig. 0159 Chrome



Fig. 0159 Plain

**PROP 65 WARNING**  
(Contains Lead)

## Fixed Mount Fog Bells

The 8 and 12 Inch Bells Listed on This Page Have Been Reviewed by the U.S. Coast Guard and Comply with C.G. 169 Regulations for Sound Signal Appliances as Required by Annex III Paragraph 2 of the '72 Colregs. The 8 Inch Size is for Use on Vessels Under 20 Meters (65.6 ft.) in Length. The 12 & 14 Inch Sizes are for Use on Vessels of any Length.

### Heavy Weight

Material: Cast Bronze  
 Finish: Plain, Polished, or Chrome Plated  
 Dimensions: 12" or 14" Bell Bottom  
 Screw Size: 1/4" R.H.



Finish	Bottom Diameter	Height Overall	Standard Pkg.
Plain	12"	12"	0158012PLB
Polished	12"	12"	0158012POL
Chrome Plated	12"	12"	0158012CHR
Plain	14"	14"	0158014PLB
Polished	14"	14"	0158014POL
Chrome Plated	14"	14"	0158014CHR

Fig. 0158 Polished



### Light Weight

Material: Wrought Brass  
 Finish: Plain  
 Dimensions: 12" Bell Bottom  
 Screw Size: #12 R.H.

Fig. 0179



Finish	Bottom Diameter	Height Overall	Standard Pkg.
Plain	12"	8"	0179012PLB



### SPARE PARTS FOR BELLS ORDERING INFORMATION

For complete Spare Part No. Insert Finish Code: P or PLB, for Plain Bronze or Brass Finish (i.e. 0420P0699A or 0127000PLB).  
 B or POL, for Polished Bronze or Brass Finish (i.e. 0420B0699A or 0127000POL).  
 C or CHR, for Chrome Plated Finish (i.e. 0420C0699A or 0127000CHR).

Figure No.	SPARE PARTS				
	ARMS	WALL PLATES	CLAPPERS	EYE BOLTS	ACORN NUTS
Spare Part No.	Spare Part No.	Spare Part No.	Spare Part No.	Spare Part No.	Spare Part No.
0420-6"	0420_0699A	0127000_	0153008CHR	0113000CHR	0465004_
0150-8"	0171000_	0127000_	0144000_	0123000PLB	0465008_
0150-12"	0150_1299A	0150_1299B	0172000_*	0172000_*	0465009_
0158-12"	0158_99A*	0158_0099A*	0172000_*	0172000_*	0465009_
0158-14"	0158_99A*	0158_0099A*	0172000_*	0172000_*	0465009_
0179	017900099A*	017900099A*	0144000_	017900099B	0465008_
0159-6"	0159_0099A	0166000_	0159C0699B	0113000CHR	0465004_
0159-8"	0159_0099A	0166000_	0153008_	0113000CHR	0465004_
	*Includes Wall Bracket	*Includes Arm	*Includes Eye Bolt	*Includes Clapper	

## Fog Horn, Ball Whistle, and Weatherstripping

### Fog Horn

Material: Aluminum, Nylon Mouthpiece  
 Finish: White Baked Enamel  
 Dimensions: Length: 12-1/2", 3-1/4" O.D.



Fig. 0162

<b>Finish</b> White	<b>Retail Pkg.</b> 0162DP0WHT
------------------------	----------------------------------



4

Searchlights, Fog Bell and Sound Devices

### "Ball Type" Whistle

Material: Polymer with 3/4" O.D. Stainless Steel Ring  
 Color: Orange  
 Dimensions: Length: 2-1/4", Width: 3/4"



Fig. 0349

<b>Color</b> Orange	<b>Retail Pkg.</b> 0349DP	<b>OEM Bulk Pkg.</b> 0349
------------------------	------------------------------	------------------------------

Note: Figs. 0162 & 0349 Conform to A.B.Y.C. Standard A-23 in Accordance with the '72 COLREGS and U.S. Inland Rules for Use on Vessels Under 5 Meters (16.4 ft.) in Length.

### Portlight Weatherstripping

Material: Open Cell Foam Rubber  
 Color: Black  
 Dimensions: Max. Width: 7/16"  
 Min. Width: 1/4"  
 Height: 3/8"  
 Features: Supplied in Ten Foot Lengths

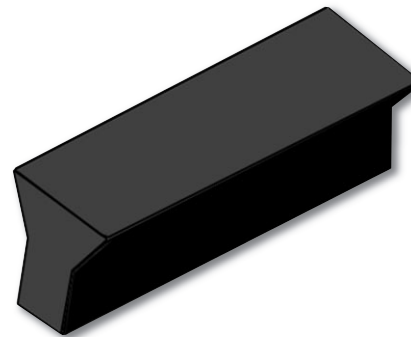

Fig. 0461

<b>Length</b> 10 Feet	<b>Std. Pkg.</b> 0461
--------------------------	--------------------------

# U.S.C.G. Electrical Standards & Wiring Diagrams

**On January 31, 1977 the U.S.C.G. Published Safety Standards for Marine Electrical Systems. These Standards Cover Such Technical Details As:**

- Batteries and Associated Conductors
- Conductor Size and Ampacity
- Strain Relief and Pull Tests
- Termination Requirements
- Overcurrent Protection
- Ignition Protection
- Grounding
- Insulation

A particular electrical component may be affected by some or all of the above categories. Those categories related to product design have been complied with, however, many additional details must be considered by the installer of the equipment as well in order to achieve compliance with this standard. It is suggested that the actual standard be familiarized when installing equipment. Perhaps one of the most critical requirements is ignition protection. A product that is marked "Ignition Protected" can be used in that area of a boat that is not isolated from a gasoline fuel vapor source. Refer to the actual standard for a determination of what parts of a boat require Ignition Protected products.

If a product is not plainly marked "Ignition Protected" then assume it is not.

**For Details On All Of The Above, Obtain The Following: U.S.C.G. Safety Standards For Electrical Systems CFR Title 33, Chapter 1, Subchapter S, Part 183, Subpart I**

## Typical Battery Switch Wiring Diagrams

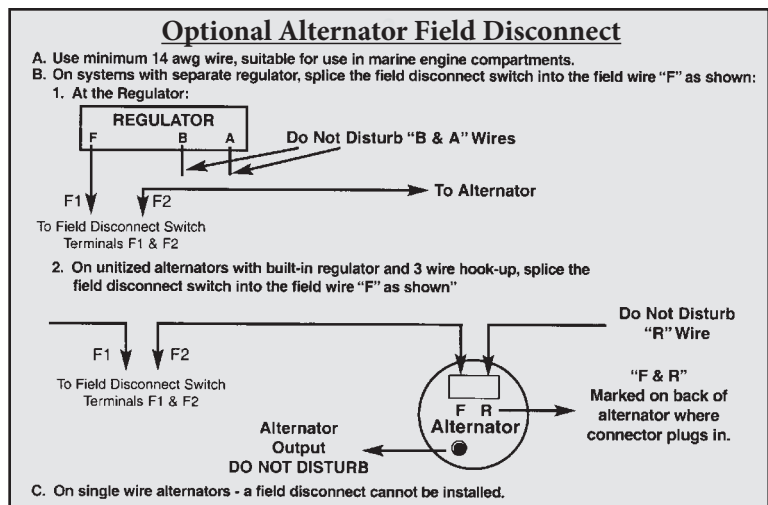
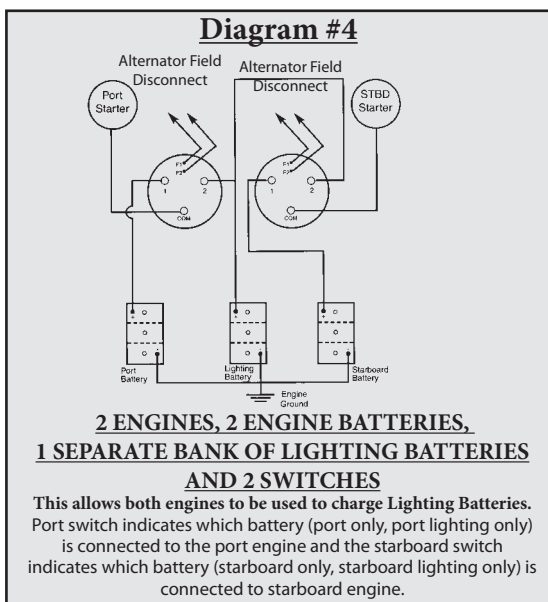
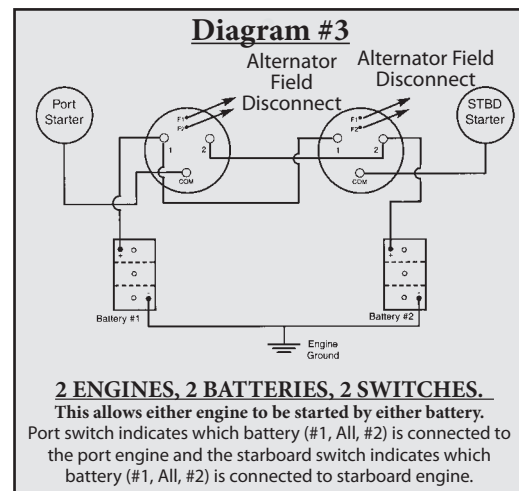
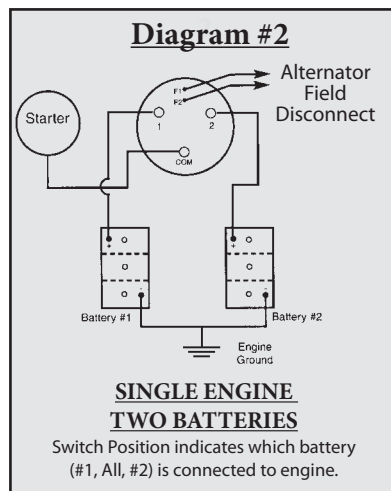
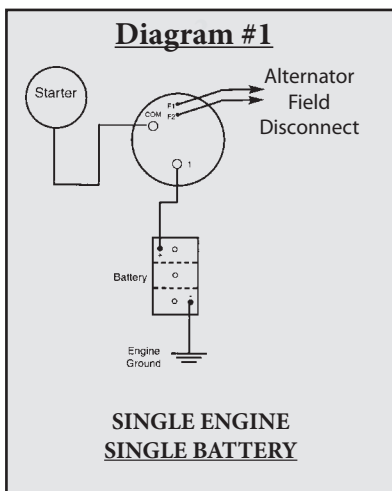

## Battery Switch Technical Information - How to Use PERKO Battery Switches

### Using Perko Battery On-Off Switches

There are many ways to use a Perko Battery On-Off Switch. The most obvious (and most common) is simply to use it to turn off your battery when in storage so that your battery does not drain as quickly and is ready to go when you are. Like all Perko products, these time-proven switches are made in the USA. All switches are ignition protected.

But for boats with multiple engines and multiple batteries, using multiple on-off switches (sometimes in conjunction with a selector switch) can provide different benefits.

Example 1: Running with a selector switch in the both position (see selector switches) may not fully charge all batteries. But adding on-off switches to the circuit you can force the alternator to charge the battery you want charged.

If you have any questions or doubt about how to use, install or wire any battery switch, consult a certified marine electrician.

**Battery disconnect switches** help manage the overall use of electrical power onboard. They are used to connect or disconnect electrical devices from the electrical system. They help to prevent battery drain during periods of inactivity. They allow for a quick and easy way to shut down the entire electrical system in an emergency. An optional key lock helps to prevent unauthorized use of the vessel.

Perko battery switches are designed for surface mounting. Standard duty disconnect switches have bright red polycarbonate reinforced housings for safety with large easy-to-turn black knobs. The housing of the heavy duty switches are red fiber-reinforced polycarbonate.

Models with an "Alternator Field Disconnect" feature offer protection for Non-Unitized Alternators should the switch accidentally be turned to the "OFF" position with the engine running.

High conductivity studs are long enough to handle more than 1 cable and strong enough for torque needed for secure connections. Optional spacer ring (PN 0462DP0RED) allows for the use of larger cables.

### Medium Duty Disconnect Switches.

#### **Figs. 9601-9604 Series:**

On-off switches are among the most popular battery switches ever produced. Their traditional Perko bolt circle makes for easy installation. These switches can be mounted in numerous locations, and as ignition protected switches, they can be installed in the engine rooms of gasoline powered boats.

Versions of this series of switches offer additional features such as alternator disconnect and key lock security.

### Compact Disconnect Switches.

#### **Figs. 9611 and 9612 Series:**

These on-off switches use the same traditional Perko footprint as the 9601-9604 Series. This makes for easy installation. These switches can be mounted in numerous locations. And as ignition protected switches, they can be installed in the engine rooms of gasoline powered boats.

Versions of the 9611 series of switches offer additional features such as alternator disconnect and key lock security.

Four removable skirt panels allow for easy cable connection from different directions. High conductivity studs are long enough to handle more than 1 cable and strong enough for torque needed for secure connections.

### New Concept Disconnect Switches.

#### **Fig. 9621 Series:**

These on-off switches offer a completely new approach to battery switches for small boats not normally equipped with the ability to shut off the electrical system. Their primary purpose is to prevent battery drain during regular periods of normal non-use.

An entirely new mounting system (designed specifically for small boats) makes these switches simple to install and to access on boats with limited space and low amperage draws. Simply cut a 3" hole, install the cup mounted switch with 4 screws, attach the cables and you're off. The integral lid closes flush to the mounting surface, protects the switch from the elements and provides a clean, professional look. To turn on or off, simply open the lid, turn the easy to hold key, and close the lid. No more dead battery.

Other series features include ignition protection, white or black mounting cups, panel and bulkhead mount options and a large plastic key that is retained or can be easily removed to prevent accidental actuation. A selector version (8521DP) is also available.

### Heavy Duty Disconnect Switches

#### **Fig. 9703 Series:**

On-off switches are among the most popular heavy duty battery switches ever produced. Their use of the traditional Perko bolt circle makes for easy installation, whether new or as a replacement. These switches can be mounted in numerous locations, and as ignition protected switches, they can be installed in the engine rooms of gasoline powered boats.

These heavy duty switches are rated at up to 450 amps continuous and 1,200 amps intermittent (see specifications). An alternator field disconnect feature is standard.

High conductivity studs are long enough to handle more than 1 cable and strong enough for torque needed for secure connections.

### Using Perko Battery Selector Switches.

There are many ways to use a Perko battery selector switch. Here is a simple way to think of the most common use.

Perko battery switches are designed for surface mounting and have bright red polycarbonate reinforced housings for safety with large easy-to-turn black knobs. Selector switches are designed with a "make before break" feature. This allows switching between the "1", the "ALL" and the "2" positions while the engine is running and the switches are ignition protected.

You always want to have enough power to start your engine to go back to shore. This begins by never leaving the dock without 2 fully charged batteries. For each trip, select one battery that you will use for your engine only for that day. Set the switch to that position (either "1" or "2"), start your engine and head out. Once there, shut off your engine and change the switch to the other position to run your accessories off the other battery. You can start and stop your engine as need be as you spend the day on the water.

**Battery selector switches** allow you to do everything a battery disconnect switch does and in addition they permit battery selection (of two or more batteries) for specific purposes including starting engines, running accessories or even recharging. They allow for the use of one or more batteries in



## Battery Switch Technical Information - How to Use PERKO Battery Switches

systems with one or more engines and facilitate putting batteries in parallel for emergency starting when one or both batteries are substantially discharged.

When you're done for the day, start your engine and head home. You will recharge that battery on your way back. But if you happened to drain it too much to start the engine, then just change the switch position to the other battery that is fully charged and you're on your way.

The "both" positions can be used in the event neither battery has enough power to start your engine. In this case using two badly discharged batteries together just may provide enough power to start. Note that running in the "both" position may not fully recharge both batteries. Recharging is best done with the switch set to either the 1 or 2 position. Once back at the dock, turn the switch to the "off" position to prevent either battery from draining while in storage.

High conductivity studs are long enough to handle more than 1 cable and strong enough for torque needed for secure connections. Optional spacer ring (PN 0462DP0RED) allows for the use of larger cables.

Always consult a certified marine electrician if you have any questions or doubt about how to use, install or wire any battery switch.

### Medium Duty Selector Switches

#### **Figs. 8501-8504 Series:**

This series of battery selector switches are among the most popular battery switches ever produced. Their use of the traditional Perko bolt circle makes for easy installation, whether new or as a replacement. These switches can be mounted in numerous locations and positions, and as ignition protected switches, they can be installed in the engine rooms of gasoline powered boats.

In addition to doing everything a battery disconnect switch does, battery selector switches permit battery selection (of two or more batteries) for specific purposes including starting engines, running accessories or even recharging. They allow for the use of one or more batteries in systems with one or more engines and facilitate putting batteries in parallel for emergency starting when one or both batteries are substantially discharged.

Versions of the 8501 Series switches offer additional features such as alternator disconnect and key lock security.

The 90° rotation feature allows users to feel the switches' position in no light situations and the classic shape of the knob makes it easy to turn.

### Compact Selector Switches

#### **Figs. 8511 and 8512 Series:**

Compact battery selector switches use the same traditional Perko bolt pattern as the 8501 series but with a smaller footprint. This makes for easy installation. These switches can be mounted in numerous locations and positions, and as ignition protected switches, they can be installed in the engine rooms of gasoline powered boats.

Versions of the 8511 series switches offer additional features such as alternator disconnect and key lock security.

Four removable skirt panels allow for easy cable connection from different directions. High conductivity studs are long enough to handle more than 1 cable and strong enough for torque needed for secure connections.

### New Concept Selector Switch.

#### **Fig. 8521 Series:**

These small selector switches offer a completely new approach to battery switches for small boats not normally equipped with the ability to shut off the electrical system. Their primary purpose is to prevent battery drain during regular periods of normal non-use. This selector version offers the option of adding a second battery to the system.

An entirely new mounting system (designed specifically for small boats) makes these switches simple to install and to access on boats with limited space and low amperage draws. Simply cut a 4" hole, install the cup mounted switch with 4 screws, attach the cables and you're off. The integral lid closes flush to the mounting surface, protects the switch from the elements and provides a clean, professional look. To turn on or off, simply open the lid, turn the easy to hold key and close the lid. No more dead battery.

Other series features include ignition protection, white or black mounting cups, panel and bulkhead mount options and a large plastic key that is retained or can be easily removed to prevent accidental actuation. An on-off version (9621DP) is also available.

### Heavy Duty Selector Switches

#### **Fig. 8603 Series:**

Perko 8603 battery selector switches are among the most popular heavy duty battery switches ever produced. Their use of the traditional Perko bolt circle makes for easy installation, whether new or as a replacement. These switches can be mounted in numerous locations, and as ignition protected switches, they can be installed in the engine rooms of gasoline powered boats.

These heavy duty switches are rated at up to 380 amps continuous and 850 amps intermittent (see specifications). An alternator field disconnect feature is standard. The 90° rotation feature of the knob allows users to feel the switches' position in no light situations, and the classic shape of the knob makes it easy to turn.

### Using Perko Cup Mount Battery Switches.

Perko's new "cup mount" system offers an entirely new approach to battery switch installations and gives owners of small boats an easy way to reduce the likelihood of a dead battery. Designed primarily for smaller boats with limited mounting location options, these switches offer an entirely new approach to battery switch installation. They let you mount a switch in places not normally thought of for switch installation like:

- On the side of center consoles
- Under seats
- Against exposed bulkheads

Switches are flush mounted on the surface with no protrusions to bump against and protected from the elements by a simple to open and close cover while the inner workings remain safely inside a compartment.

The cup mount switches are easy to install and simple to access while remaining completely out of the way.

# A NEW LOOK FOR BATTERY SWITCHES

*Create New Sales and Installation Opportunities*

*Introducing  
The Cup Mount*

5

Battery Switches and Electrical Components



**NEW  
PRODUCT**

**Ideal for:**

- Tenders
- Skiffs
- Flats Boats
- Inflatables
- Small Boats

**Mounts on:**

- Consoles
- Lockers
- Storage bulkheads
- Interior gunnel walls
- Under bench seats

**PERKO**, INC.

Manufacturer of Marine Navigation Lights, Hardware and Accessories for over 100 Years



# A SWITCH FOR ANY APPLICATION

*From a Trusted Brand in the Marine Industry*

- Proven Quality and Reliability
- Single Battery Disconnect or Dual Battery Selector Switch Options

See Pages 80-84

## Compact Design

### SINGLE BATTERY ON/OFF



**Backing Plate**  
For panel mount applications



**Cup Mount**  
For recessed mounting applications

**NEW PRODUCT**

### DUAL BATTERY SELECTOR

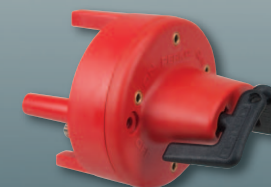

**Stand-Off**  
For bulkhead mounting applications

## Medium Duty



## Medium Duty +



## Heavy Duty



**PERKO**, INC

Manufacturer of Marine Navigation Lights, Hardware and Accessories for over 100 Years

## Cup Mount - Compact Battery Switches

### Cup Mount Options for Battery, Disconnect and Selector Switches, Ignition Protected

For use with alternators and generators 6-50 V.D.C. Marine Electrical Systems

Material: Polycarbonate Body with Nickel Plated Terminals  
 Finish: **Body:** Red and Black  
           **Cup:** Off White or Black  
 Dimensions: **9621:** Cup Diameter: 3-1/2", Installs in 3" Dia. Hole  
               **8521:** Cup Diameter: 4-1/2", Installs in 4" Dia. Hole  
 Screw Size: For Mounting Cup: #6  
 Terminal Stud Size: 3/8"  
 Rated: 140 Amps Continuous,  
 200 Amps 5 Min. Intermittent  
 250 Amps 30 Second Start

- Features:
- Small compact size
  - Attractive, durable easy open/close cover hides and protects switch face
  - Allows for easy battery switch access without opening hatches, doors or reaching into tight spaces
  - Removable actuator key

**Ideal For:** Tenders, Skiffs, Flats Boats, Inflatables or Small Boats

**Mounts On:** Consoles, Lockers, Storage Bulkheads, Interior Gunnel Walls or Under Bench Seats



**NEW PRODUCT**

**Fig. 9621 with Cup**



**Removable Actuator Key**



**Retail Package**

Description	Cup Color	Retail Pkg.	OEM Bulk Pkg.
Selector Switch with Cup	Off White	8521DPC	8521C
Selector Switch with Cup	Black	8521DPCBLK	8521BC
Disconnect Switch w/Cup	Off White	9621DPC	9621C
Disconnect Switch w/Cup	Black	9621DPCBLK	9621BC
<b>Spare Parts:</b>			
Spare Actuator Key - Fig 9621		9621DPOKEY	
Spare Actuator Key - Fig 8521		8521DPOKEY	



**Cup Available Off White or Black**

**Fig. 8521 Selector Switch**

### Shown Mounted on Flats Boat Console



**Open**



**Closed**



## Panel and Bulkhead Mount - Compact Battery Selector & Disconnect Switches

### Compact Selector and Disconnect Switches, Ignition Protected

For use with alternators and generators 6-50 V.D.C. Marine Electrical Systems

Material: Polycarbonate Body with Nickel Plated Terminals  
 Finish: Red and Black  
 Dimensions: **9621:** Face: 3" x 2-1/2"  
**8521:** Face: 3-7/8" x 3-1/4"  
 Screw Size: #10  
 Terminal Stud Size: 3/8"  
 Rated: 140 Amps Continuous,  
 200 Amps 5 Min. Intermittent  
 250 Amps 30 Second Start

Installation: **9621:** Hole Size: 2-1/8"  
**8521:** Hole Size: 3"

Features:

- **Two mounting options:**
  - Panel mount with backing plate
  - Bulkhead mount with mounting legs
- Small compact size
- Removable actuator key

**Ideal For:** Tenders, Skiffs, Flats Boats, Inflatables or Small Boats

**Mounts On:** Consoles, Lockers, Storage Bulkheads, Interior Gunnel Walls or Under Bench Seats



**Fig. 9621**  
Disconnect Switch

**NEW**  
PRODUCT



**Fig. 8521**  
Selector Switch

Description	Retail Pkg.	OEM Bulk Pkg.
Selector Switch w/Mtg Ring & Legs	8521DP	
Selector Switch Only w/Ring	-----	8521R
Selector Switch Only w/Legs	-----	8521L
Disconnect Switch w/Mtg Ring & Legs	9621DP	-----
Disconnect Switch Only w/Ring	-----	9621R
Disconnect Switch Only w/Legs	-----	9621L
<b>Spare Parts:</b>		
Fig. 8521: Spare Actuator Key	8521DP0KEY	
Fig. 9621: Spare Actuator Key	9621DP0KEY	

### Mounting Options

#### Panel Mount with Backing Plate



#### Shown Mounted



#### Bulkhead Mount with Mounting Legs



#### Shown Mounted



Retail Packages includes both backing plate and mounting legs



Removable Actuator Key



## Compact Battery Selector & Disconnect Switches

### Compact Main Battery Selector & Disconnect Switches, Ignition Protected

For use with alternators and generators 6-50 V.D.C. Marine Electrical Systems  
 Protected by the following U.S. Patents; Design 260,637 - 4,280,028 - 4,424,424



- Material: Polycarbonate Body with Brass Terminals  
 Finish: Red and Black  
 Dimensions: Width: 4", Height 4", Depth: 3"  
 Rated: 315 Amps Continuous,  
 450 Amps 5 Min. Intermittent  
 Terminal Stud Size: 3/8"  
 Features:
- Higher Rating Capacity than the 8500 Series
  - Requires 1/3rd less space to mount
  - Same Bolt Pattern as Popular 8500 Series
  - Locking and Non-Locking Models
  - Smooth, Positive 90° Rotary Position Selector
  - Four removable skirt panels for easy cable access and mounting

Fig. 8511  
Selector Switch

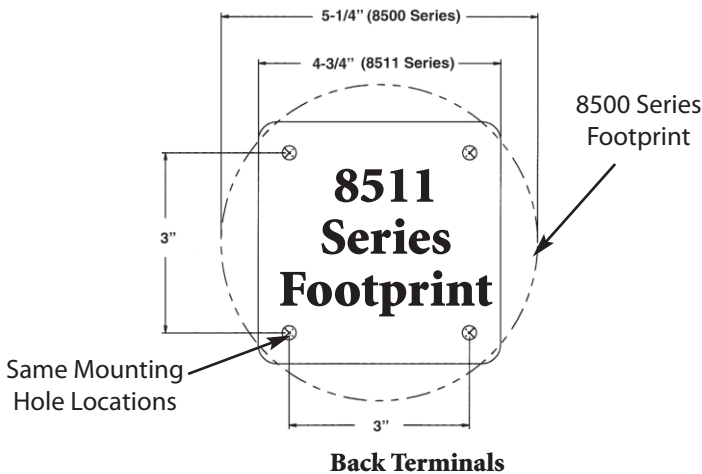

Fig. 8512

- Fig. 8511: Selector Switch  
 Fig. 8512: Selector Switch with Key Lock  
 Fig. 9611: Disconnect (On/Off) Switch  
 Fig. 9612: Disconnect (On/Off) Switch with Key Lock

Features	Retail Pkg.	OEM Bulk Pkg.	Alternator Field Disconnect
Selector w/o Key Lock	8511DP	8511	No
Selector with Key Lock	8512DP	8512	No
Disconnect w/o Key Lock	9611DP	9611	No
Disconnect with Key Lock	9612DP	9612	No

Surface Mount Trim Ring: 8511TRMRNG



Same Mounting Hole Locations

Fig. 9612  
Disconnect Switch



Fig. 9611

Disconnect Switch

Selector Switch



Surface Mounting Trim Ring Available

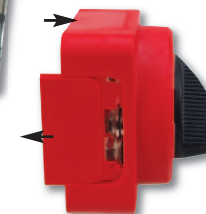

Illustration of removable skirt panels



## Medium Duty Battery Selector and Disconnect Switches

### Medium Duty, Main Battery Selector & Disconnect Switches, Ignition Protected

For use with alternators and generators 6-50 V.D.C. Marine Electrical Systems  
Protected by the following U.S. Patents; Design 260,637 - 4,280,028 - 4,424,424



Material: Polycarbonate Body with Brass Terminals  
Finish: Red and Black  
Dimensions: Diameter: 5-1/4", Depth: 2-5/8"

Rated: 250 Amps Continuous,  
360 Amps 5 Min. Intermittent

Terminal Stud Size: 3/8"

- Features:
- Smooth, Positive 90° Rotary Position Selector
  - Alternator Field Disconnect: When used with non-unitized alternators, these models will interrupt the field current (reducing the possibility of damage) if turned "OFF" with the engine running.

- Fig. 8501: Selector Switch  
Fig. 8502: Selector Switch with Key Lock  
Fig. 8503: Selector Switch w/Alt. Field Disc.  
Fig. 8504: Selector Switch with Key Lock and Alt. Field Disc.  
Fig. 9601: Disconnect (On/Off) Switch  
Fig. 9602: Disconnect (On/Off) Switch with Key Lock  
Fig. 9603: Disconnect (On/Off) Switch w/Alt. Field Disc.  
Fig. 9604: Disconnect (On/Off) Switch with Key Lock and Alt. Field Disc.



Fig. 8502



Fig. 8503



Fig. 8504

### Fig. 9602 Disconnect Switch with Ley Lock



Fig. 9601



Fig. 9603

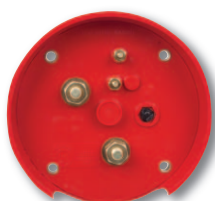

Fig. 9604

Features	Retail Pkg.	OEM Bulk Pkg.	Alternator Field Disconnect
Selector w/o Key Lock	8501DP	8501	No
Selector with Key Lock	8502DP	8502	No
Selector w/o Key Lock	8503DP	8503	Yes
Selector with Key Lock	8504DP	8504	Yes
Disconnect w/o Key Lock	9601DP	9601	No
Disconnect with Key Lock	9602DP	9602	No
Disconnect w/o Key Lock	9603DP	9603	Yes
Disconnect with Key Lock	9604DP	9604	Yes
Cable Spacer	0462DP0RED	0462000RED	

#### Back Terminals

#### Disconnect Switch



with Alternator Field Disconnect

#### Selector Switch

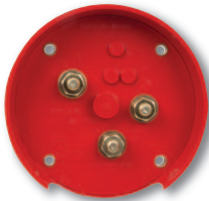

without Alternator Field Disconnect

#### Fig. 0462



Optional Cable Spacer



## Heavy Duty Battery Selector and Disconnect Switches

### Heavy Duty Main Battery Selector Switch, Ignition Protected

For use with alternators and generators 6-50 V.D.C. Marine Electrical Systems  
 Protected by the following U.S. Patents; Design 260,637 - 4,280,028 - 4,424,424

- Material: Polycarbonate Body with Brass Terminals
- Finish: Red and Black
- Dimensions: Width: 5-1/2", Height 5-1/2", Depth: 3-5/8"
- Rated: 380 Amps Continuous,  
850 Amps 5 Min. Intermittent
- Screw Size: #10
- Terminal Stud Size: 1/2"
- Features: Selector Switch  
with Alternator Field Disconnect



Fig. 8603



**Features**  
Selector Switch

**Retail Pkg.**  
8603DP

**Alternator Field Disconnect**  
Yes

### Heavy Duty Main Battery Disconnect Switch, Ignition Protected

For use with alternators and generators 6-50 V.D.C. Marine Electrical Systems  
 Protected by the following U.S. Patents; Design 260,637 - 4,280,028 - 4,424,424

- Material: Polycarbonate Body with Brass Terminals
- Finish: Red and Black
- Dimensions: Width: 5-1/2", Height 5-1/2", Depth: 3-5/8"
- Rated: 450 Amps Continuous,  
1200 Amps 5 Min. Intermittent
- Screw Size: #10
- Terminal Stud Size: 1/2"
- Features: Disconnect (On/Off) Switch  
with Alternator Field Disconnect



Fig. 9703



**Features**  
Disconnect Switch

**Retail Pkg.**  
9703DP

**Alternator Field Disconnect**  
Yes

## In-line Fuse Holder, Cable Straps and Line Support Clips

### In-Line Fuse Holder

Material: Molded Polymer  
 Dimensions: Length: 2-1/8", Diameter: 11/16"  
 Rated: 20 Amps at 12, 24 and 32 Volts For 1/4" x 1-1/4" Fuses  
 Voltage: 12V  
 Features: Includes 7-1/2" Wire Leads



Fig. 0786

Type	Retail Pkg.
In-Line Fuse Holder	0786DP

### Cable Strap

Material: Ultra-Violet Stabilized Polymer for Weather Resistance  
 Dimensions: Width All Sizes: 1/2"  
 Screw Size: #4  
 Features: Eliminates the Need for Insulating Cushion



Fig. 0196

I.D. Inches	Retail Pkg.	OEM Bulk Pkg.
3/16"	0196DP1	0196001
1/4"	0196DP2	0196002
5/16"	0196DP3	0196003
3/8"	0196DP4	0196004
1/2"	0196DP5	0196005
5/8"	0196DP6	0196006
3/4"	0196DP7	0196007

Note: This Item Conforms to U.S.C.G. Electrical Standards. See page 75.

### Line Support Clips

Material: Aluminum with Synthetic Rubber Cushion



Fig. 0163  
Single Line

For O.D. Line	Width	Single Line Retail Pkg.	Double Line Retail Pkg.
1/4"	3/8"	0163DP2ALU	-----
3/8"	1/2"	0163DP4ALU	0164DP4ALU
1/2"	1/2"	0163DP5ALU	0164DP5ALU*
5/8"	1/2"	0163DP6ALU	-----



Fig. 0164  
Double Line

Note: This Item Conforms to U.S.C.G. Electrical Standards. See page 75.



## Deck Connections & Cable Outlet

### Watertight Deck Connections

Material: Fig. 1189 Brass  
 Fig. 1190 Zinc Alloy  
 Finish: Chrome Plated  
 Dimensions: Height: 1-3/16", Diameter: 1-5/8"  
 Screw Size: #6  
 Rated: 15 Amps at 12, 24 and 32 Volts Polarized Double Contact Connector. Accepts up to #14 gauge stranded wire  
 Voltage: 12, 24, or 32V  
 Features: Includes flange gasket with integral waterproof cap for base when plug is removed



**Fig. 1189**  
**Chrome Plated Brass**  
**Fig. 1190**  
**Chrome Plated Zinc**

Finish	Retail Pkg.	OEM Bulk Pkg.
Chrome Brass	1189DP0CHR	1189000CHR
Chrome Zinc	1190DP0CHR	1190000CHR

**Note: These Items Are Not Ignition Protected.**

**Spare Parts Ordering Information**  
 Connector with Cover: 1189DP099A.  
 Connector Only: 0042.



### Watertight Cable Outlet

Material: Brass  
 Finish: Chrome Plated  
 Dimensions: Diameter Base: 1-1/4"  
 Screw Size: #4  
 Features:
 

- For 5/16 Inch O.D. Cable
- Equipped with Rubber Grommet for Watertight Passage of Cable



**Fig. 0424**  
**Chrome Plated Brass**

Finish	Retail Pkg.
Chrome	0424DP0CHR





# FlushPro™ Valve and Winterizing Kit

**FlushPro™ Marine Engine Flushing and Winterizing Valve** - Flush your boat engine safely and easily  
**Freshwater Flushing of Your Inboard is as Simple as Connecting a Garden Hose**

- Material: Polycarbonate, with Stainless Steel Spring  
 Finish: Clear  
 For Hose Sizes: 5/8", 1" or 1-1/4"  
 Features:
- Transparent body allows for visual inspection of water flow
  - Durable check valve system activated by water pressure from a garden hose
  - Check valve automatically shuts off hull intake when water pressure is applied
  - Adapter supplied with FlushPro™ makes winterizing your boat easy
  - Can be used with onboard generators



Fig. 0456

Finish	Hose Size "A" Dimension	Retail Pkg.	OEM Bulk Pkg.
Valve	5/8	0456DP4	0456004
Valve	1	0456DP6	0456006
Valve	1-1/4	0456DP7	0456007
Valve & Kit	5/8	0457DP4	0457004
Valve & Kit	1	0457DP6	0457006
Valve & Kit	1-1/4	0457DP7	0457007

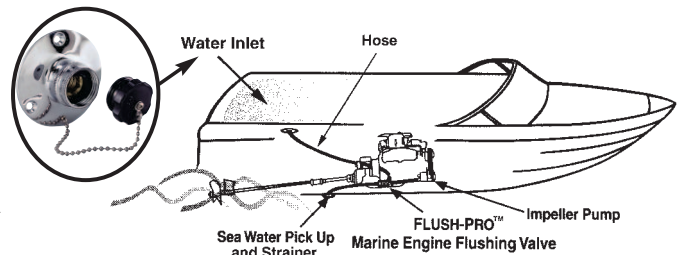
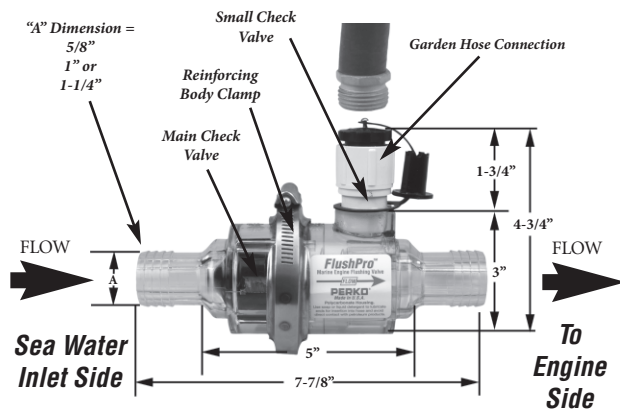

**PROP 65 WARNING**  
 (Contains Lead & DINP)

6

Underwater Hardware

FIG. 0456 - DIFFERENTIAL PRESSURE GRAPH

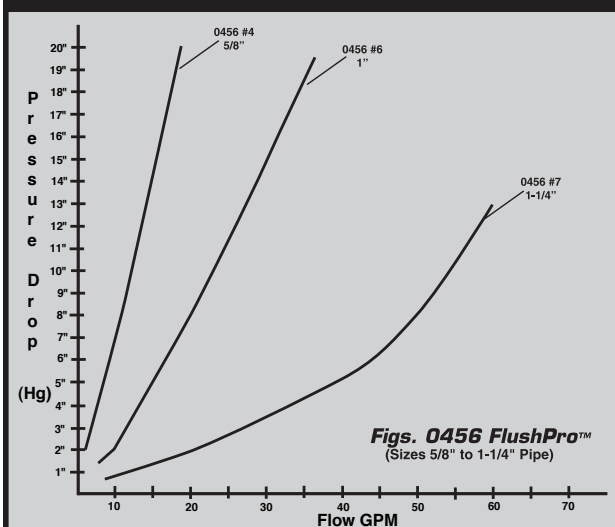

## FlushPro™ Marine Engine Flushing & Winterizing Kit

**Kit includes:**

- FlushPro™ Valve with Two Clamps
- Hose Fittings & Clamps
- 7' of Hose
- Fig. 0499 Water Inlet Fitting

Fig. 0457



## Intake Water Strainers

### Flushing Strainer

Freshwater flushes your inboard or generator simply and easily

Material: Cast Bronze, Stainless Steel Basket and Clear Polycarbonate Cylinder  
 For Pipe Sizes: 1/2" to 1-1/4" NPT  
 Uses: For Flushing, Winterizing and acts as an Emergency Bilge Pump

- Features:
- Handle Indicates Flow Direction
  - Top Casting Removes Easily for Basket Cleaning
  - Reversible Bulkhead Mounting Option
  - Smooth Acting, Low Torque Ball Valve
  - Internal Cam Seals Fresh Water Intake During Normal (Through Strainer) Operation
  - Uses Standard Perko Strainer Replacement Parts (Gaskets, Cylinders, Nuts, and Tie Rods)
  - Designed for easy installation and cleaning
  - Mounting lugs cast into both sides to assure universal mounting
  - Four outside tie rods
  - Stainless steel strainer basket minimizes electrolysis
  - 0.079" Screen hole diameter provides 47% open area, among the highest in the industry for cylindrical strainer baskets.
  - Hinged lugs on cover permit easy removal and cleaning of the strainer basket
  - A drain plug in the bottom casting for easily removing sediment and draining for winterizing

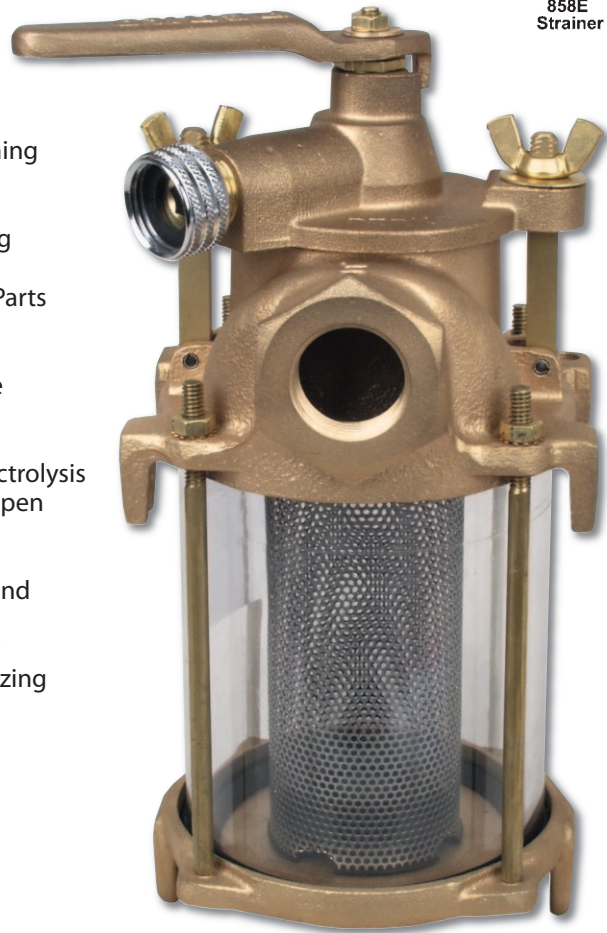
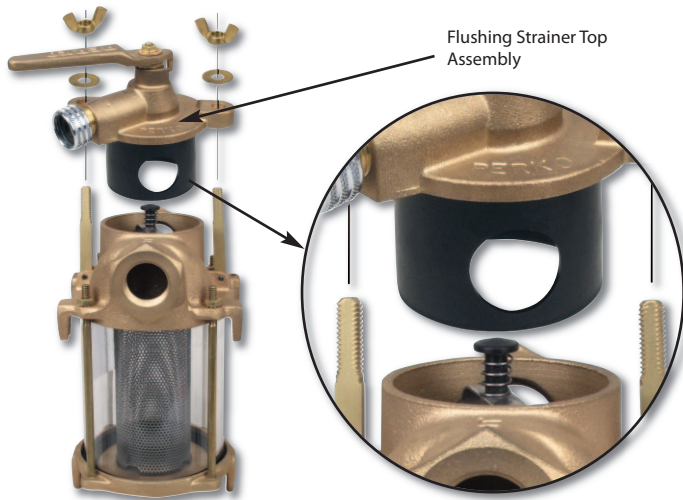

Fig. 0593



Flushing Strainer Top Assembly



Pipe Size	Height Overall	Width Overall	Standard Pkg.	Dimensions Cylinder	Dimensions Basket	Open Area To Pipe Size Ratio	Spare Gasket Kit* Retail Pkg.
1/2"	5-3/4"	4-1/2"	0593004PLB	3-1/2" x 4"	1-13/16" x 4-1/16"	30:1	0493DP599R
3/4"	8-3/8"	4-1/2"	0593005PLB	3-1/2" x 6"	1-13/16" x 6-1/4"	25:1	0493DP599R
1"	9-1/2"	5-1/2"	0593006PLB	4-1/2" x 5-1/2"	2-5/8" x 5-7/8"	20:1	0493DP799R
1-1/4"	10"	5-1/2"	0593007PLB	4-1/2" x 6"	2-5/8" x 6-1/4"	13:1	0493DP799R

\*Spare Gasket Kit Consists of: 1 Cover Gasket and 2 Cylinder Gaskets

## Fig. 0593 Flushing Strainer Spare Parts

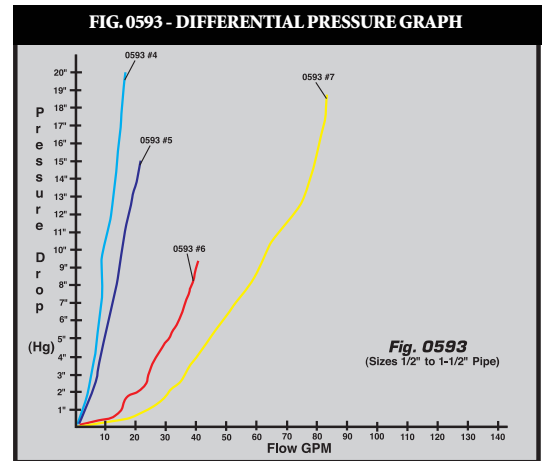
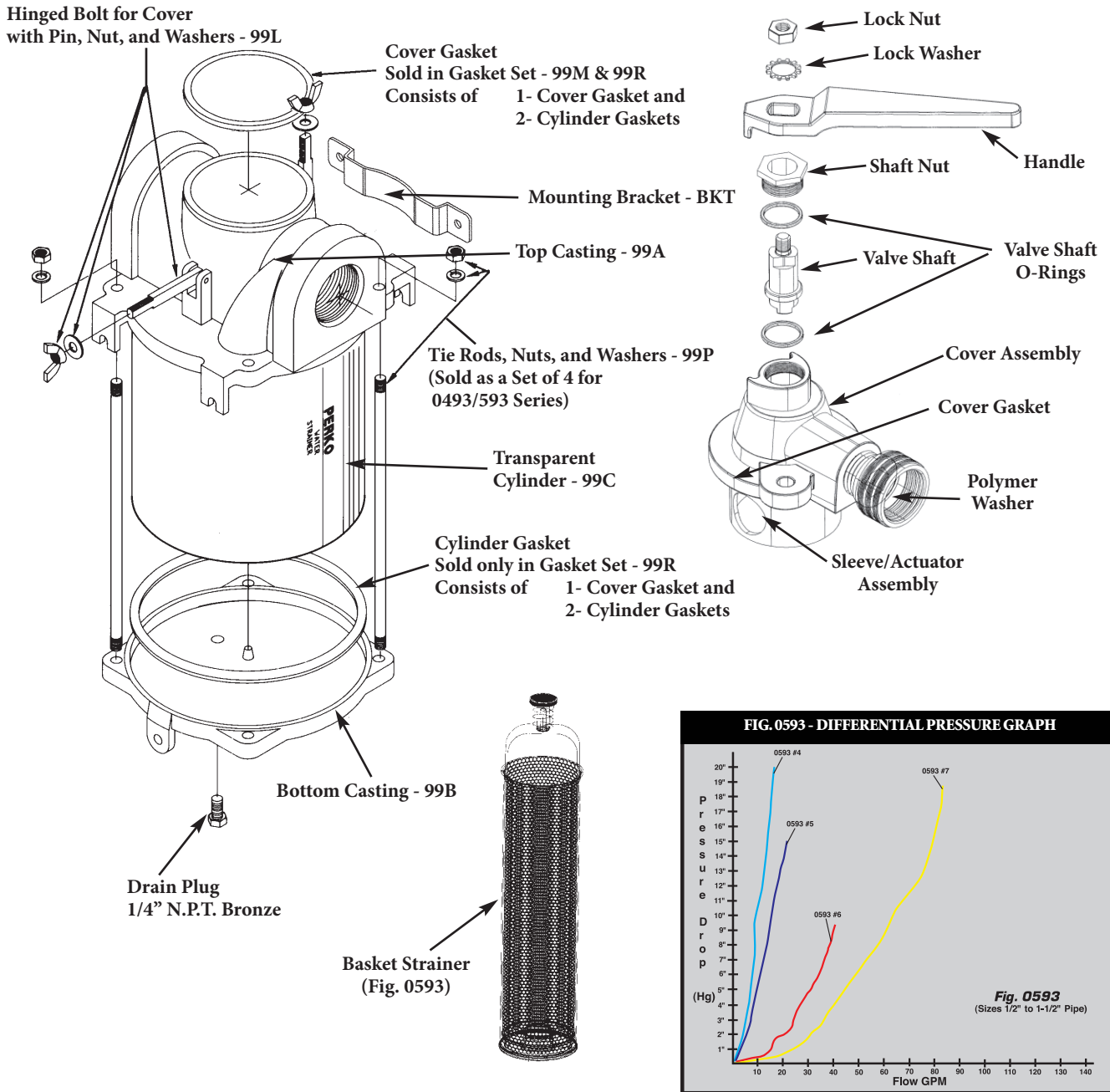

### Spare Parts Information For Fig. 0593 Flushing Strainer Only

Description	Spare Part Code	Sample Part Number	Package	Description	Spare Part Code	Sample Part Number	Package
Handle (Fig. 0805)	99D	080500599D**	Boxed	Cover Assy.	99C	059300499C	Boxed
Valve Shaft	99A	059300499A	Boxed	Basket Strainer	99D	059300499D	Boxed
Sleeve Assy.	99B	059300499B	Boxed				

\*\* For Complete Handle Part Numbers See Fig. 0805 on page 98.

### Intake Water Strainer & Flushing Strainer Common Spare Parts Ordering Information

For Spare Part No. Insert a Spare Part Code Listed Below in Place of the "PLB" in the Strainer's Catalog Number (i.e., 049300699A, Top Casting for 1" (#6) Strainer).

Description	Spare Part Code	Sample Part Number	Package	Spare Part Description	Sample Code	Part Number	Package
Top Casting	99A	049300499A	Boxed	Rubber Gasket Kit Consists of:			
Bottom Casting	99B	049300499B	Boxed	1- Cover Gasket and			
Transparent Cylinder	99C	049300499C	Boxed	2- Rubber Cylinder Gaskets	99R*	0493DP599R	Bag
Cover with Gasket	99E	049300499E	Boxed	Tie Rods, Nuts, and Washers			
Cork Cover Gasket Kit (Set of 2)	99N	0493DP599N	Bag	Consists of (4 Each for 0493 Series)	99P	0493DP499P	Bag

## Clear Body Intake Water Strainer

### Lightweight Intake Water Strainer with Clear Body

Material: Cast Bronze with Clear Polycarbonate Body and Stainless Steel Basket

For Pipe Sizes: 1/2" to 1-1/4" NPT

- Features:
- Many Replacement Parts in Common with Other Perko Strainers (Fig. 0493)
  - Our Lightest Weight Strainer Series
  - Designed for easy installation and cleaning
  - Mounting lugs cast into both sides to assure universal mounting
  - Stainless steel strainer basket minimizes electrolysis
  - 0.079" Screen hole diameter provides 47% open area, among the highest in the industry for cylindrical strainer baskets
  - Hinged lugs on cover permit easy removal and cleaning of the strainer basket
  - A drain plug in the bottom casting for easily removing sediment and draining for winterizing



Fig. 0443

FIG. 0443 - DIFFERENTIAL PRESSURE GRAPH

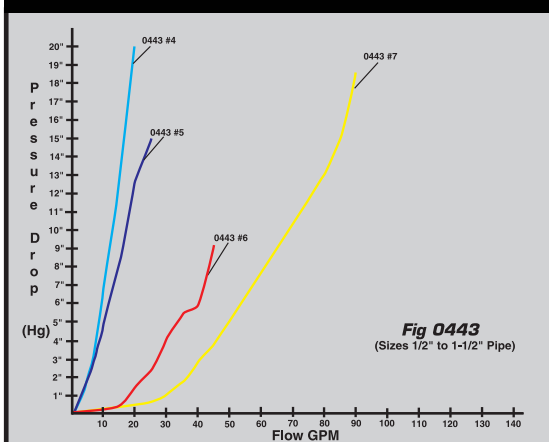

Pipe Size	Standard Pkg.	Height Overall	Width Overall	Dimensions Cylinder (O.D. x L)	Dimensions Basket	Open Area To Pipe Size Ratio	Spare Gasket Kit* Retail Pkg.
1/2"	0443004PLB	6-1/4"	4-1/2"	3-1/2" x 4-1/4"	1-13/16" x 4-1/16"	30:1	0443DP599R
3/4"	0443005PLB	8-5/8"	4-1/2"	3-1/2" x 6-5/8"	1-13/16" x 6-1/4"	25:1	0443DP599R
1"	0443006PLB	8-3/4"	5-1/2"	4-1/2" x 6"	2-5/8" x 5-7/8"	20:1	0443DP799R
1-1/4"	0443007PLB	9-5/16"	5-1/2"	4-1/2" x 6-9/16"	2-5/8" x 6-1/4"	13:1	0443DP799R

\*Spare Gasket Kit Consists of: 1 Cover Gasket and 2 Cylinder Gaskets

## Fig. 0443 Clear Body Intake Water Strainer Spare Parts

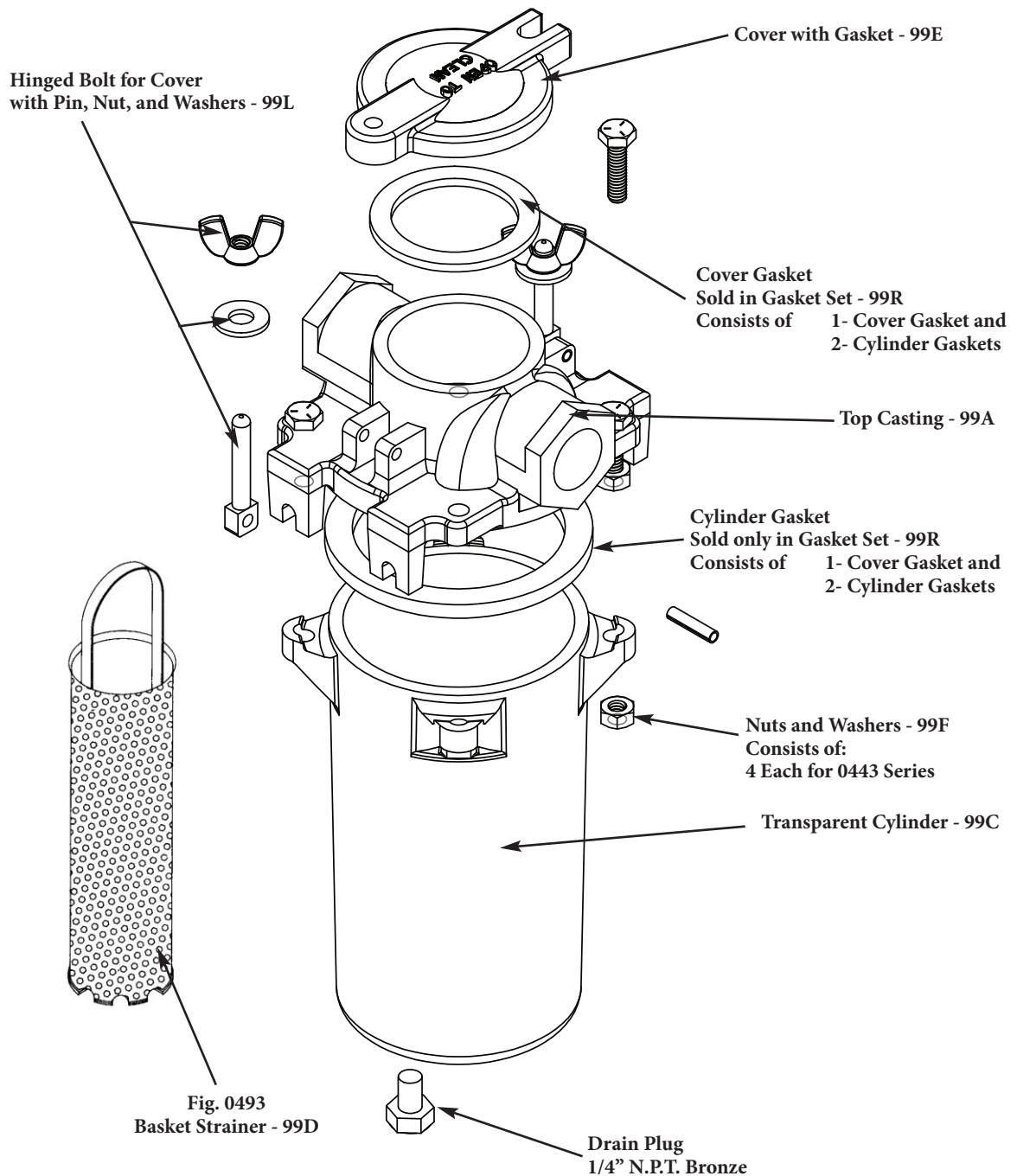

6 Underwater Hardware

### Spare Parts Ordering Information

For Spare Part No. Insert a Spare Part Code Listed Below in Place of the "PLB" in the Strainer's Catalog Number (i.e., 049300699A, Top Casting for 1" (#6) Strainer).

Description	Spare Part Code	Sample Part Number	Package	Description	Spare Part Code	Sample Part Number	Package
Top Casting	99A	049300499A	Boxed	Hinged Bolt for Cover With Pin, Nut, and Washer	99L	0493DP599L	Bag
Transparent Cylinder Body	99C	044300499C	Boxed	Rubber Gasket Kit Consists of:			
Basket Strainer	99D	049300499D	Boxed	1- Cover Gasket and			
Cover with Gasket	99E	049300499E	Boxed	2- Rubber Cylinder Gaskets	99R*	0493DP599R	Bag
				Nuts and Washers Consists of:			
				4 Each for 0443 Series	99F	0443DP499F	Bag

## Intake Water Strainers

### Intake Water Strainers

**Material:** Cast Bronze, 316 Stainless Steel Basket and Clear Polycarbonate Cylinder  
**For Pipe Sizes:** 1/2" to 2-1/2" NPT

- Features:**
- Designed for easy installation and cleaning
  - Mounting lugs cast into both sides to assure universal mounting
  - Four outside tie rods
  - Stainless steel strainer basket minimizes electrolysis
  - 0.079" Screen hole diameter provides 47% open area, among the highest in the industry for cylindrical strainer baskets
  - Hinged lugs on cover permit easy removal and cleaning of the strainer basket
  - A drain plug in the bottom casting for easily removing sediment and draining for winterizing



Fig. 0493



FIGS. 0493 & 0593 - DIFFERENTIAL PRESSURE GRAPHS

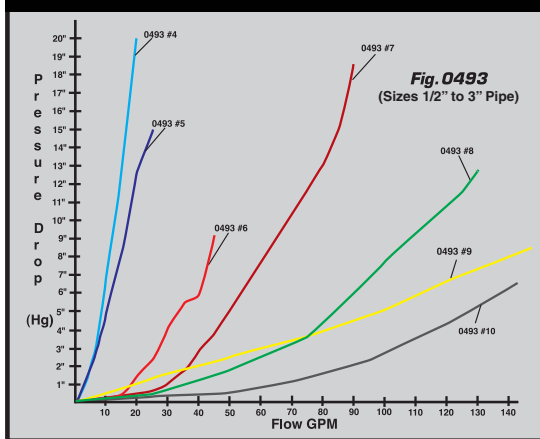

Pipe Size	Height Overall	Width Overall	Standard Pkg.	Dimensions Cylinder	Dimensions Basket	Open Area To Pipe Size Ratio	Spare Gasket Kit* Retail Pkg.
1/2"	5-3/4"	4-1/2"	0493004PLB	3-1/2 x 4"	1-13/16" x 4-1/16"	30:1	0493DP599M (or) 99R
3/4"	8-3/8"	4-1/2"	0493005PLB	3-1/2 x 6"	1-13/16" x 6-1/4"	25:1	0493DP599M (or) 99R
1"	9-1/2"	5-1/2"	0493006PLB	4-1/2 x 5-1/2"	2-5/8" x 5-7/8"	20:1	0493DP799M (or) 99R
1-1/4"	10"	5-1/2"	0493007PLB	4-1/2 x 6"	2-5/8" x 6-1/4"	13:1	0493DP799M (or) 99R
1-1/2"	11-1/2"	7-1/4"	0493008PLB	6 x 8"	3-5/16" x 8-7/16"	17:1	0493DP999M (or) 99R
2"	16"	7-1/2"	0493009PLB	6 x 12"	3-5/16" x 12-1/4"	13:1	0493DP999M (or) 99R
2-1/2"	16"	7-1/2"	0493010PLB	6 x 12"	3-5/16" x 12-1/2"	10:1	0493DP999M (or) 99R

\*Spare Gasket Kit Consists of: 1 Cover Gasket and 2 Cylinder Gaskets

## Fig. 0493 Intake Water Strainer Spare Parts

Hinged Bolt for Cover  
with Pin, Nut, and Washers - 99L

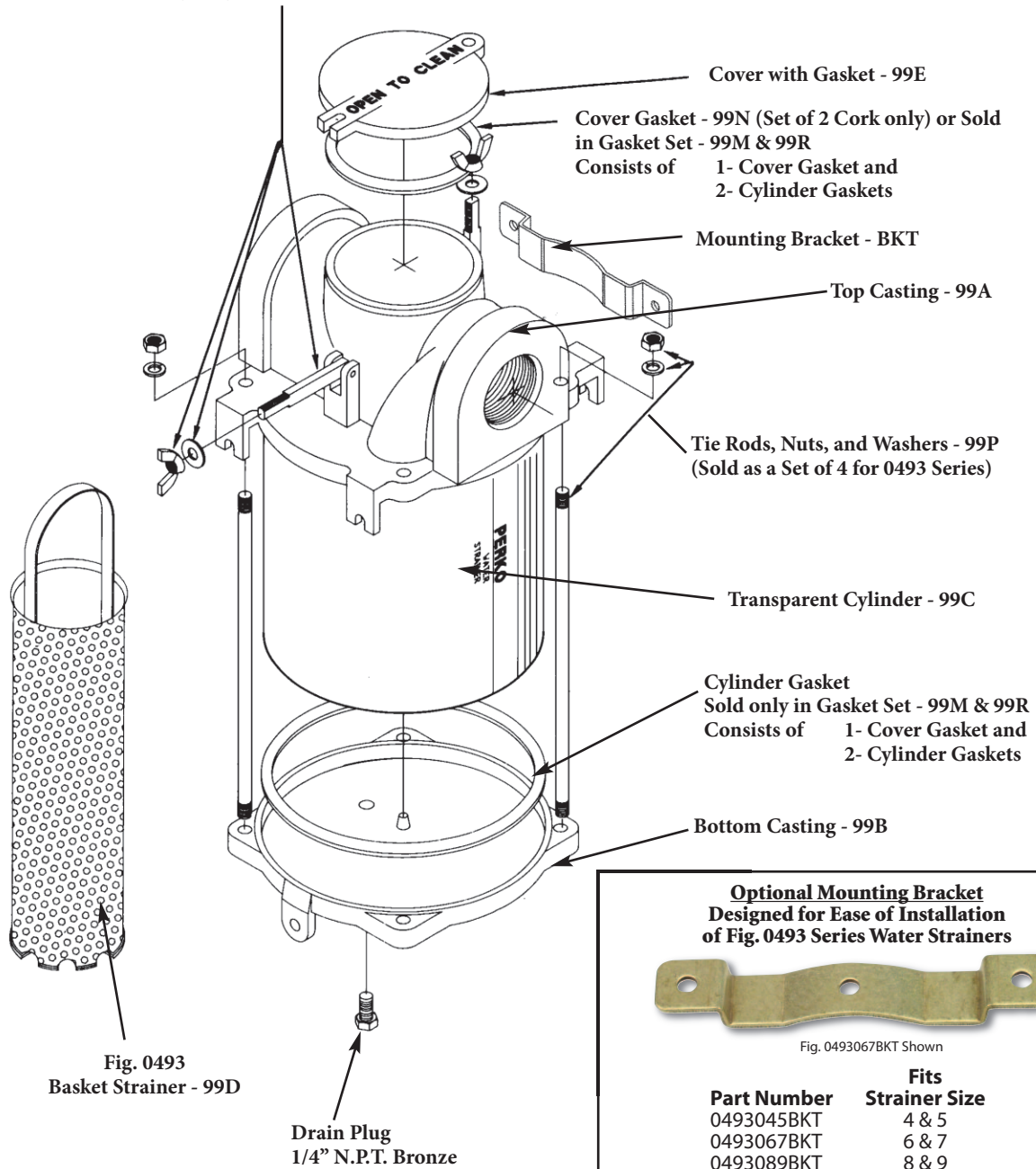

### Spare Parts Ordering Information

For Spare Part No. Insert a Spare Part Code Listed Below in Place of the "PLB" in the Strainer's Catalog Number (i.e., 049300699A, Top Casting for 1" (#6) Strainer).

Description	Spare Part Code	Sample Part Number	Package	Description	Spare Part Code	Sample Part Number	Package
Top Casting	99A	049300499A	Boxed	Cork Gasket Kit Consists of:			
Bottom Casting	99B	049300499B	Boxed	1- Cover Gasket and			
Transparent Cylinder	99C	049300499C	Boxed	2- Cork Cylinder Gaskets	99M*	0493DP599M	Bag
Basket Strainer	99D	049300499D	Boxed	Rubber Gasket Kit Consists of:			
Cover with Gasket	99E	049300499E	Boxed	1- Cover Gasket and			
Hinged Bolt for Cover				2- Rubber Cylinder Gaskets	99R*	0493DP599R	Bag
With Pin, Nut and Washer	99L	0493DP599L	Bag	Tie Rods, Nuts, and Washers			
Cork Cover Gasket Kit (Set of 2)	99N	0493DP599N	Bag	Consists of (4 Each for 0493 Series)	99P	0493DP499P	Bag

\* Note: Older model strainers utilizing cork cylinder gaskets must order 99M Cork Gasket Kit and newer model strainers must order 99R Rubber Gasket Kit.

## Higher Capacity Intake Water Strainer

### Intake Water Strainers

Material: Cast Bronze, Stainless Steel Basket and Clear Polycarbonate Cylinder  
 For Pipe Sizes: 2", 2-1/2", and 3" NPT  
 Use: For Applications requiring Higher Capacity

- Features:
- Designed for easy installation and cleaning
  - Mounting lugs cast into both sides to assure universal mounting
  - Four outside tie rods
  - Stainless steel strainer basket minimizes electrolysis
  - 0.079" Screen hole diameter provides 47% open area, among the highest in the industry for cylindrical strainer baskets.
  - Hinged lugs on cover permit easy removal and cleaning of the strainer basket
  - A drain plug in the bottom casting for easily removing sediment and draining for winterizing



Fig. 0500

FIG. 0500 - DIFFERENTIAL PRESSURE GRAPHS

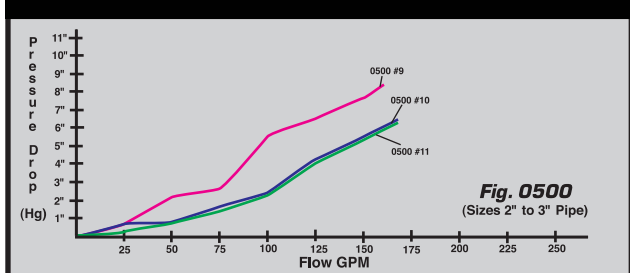

Pipe Size	Height Overall	Width Overall	Standard Pkg.	Dimensions Cylinder	Dimensions Basket	Open Area To Pipe Size Ratio	Spare Gasket Kit* Retail Pkg.
2"	14-1/2"	9"	0500009PLB	8" x 10"	3-7/8" x 10-1/4"	20:1	0500DP999M (or) 99R
2-1/2"	16-1/2"	9"	0500010PLB	8" x 12"	3-7/8" x 12-1/4"	18:1	0500DP999M (or) 99R
3"	18-1/2"	9"	0500011PLB	8" x 14"	3-7/8" x 14-1/4"	14:1	0500DP999M (or) 99R

\*Spare Gasket Kit Consists of: 1 Cover Gasket and 2 Cylinder Gaskets



## Fig. 0500 Intake Water Strainer Spare Parts

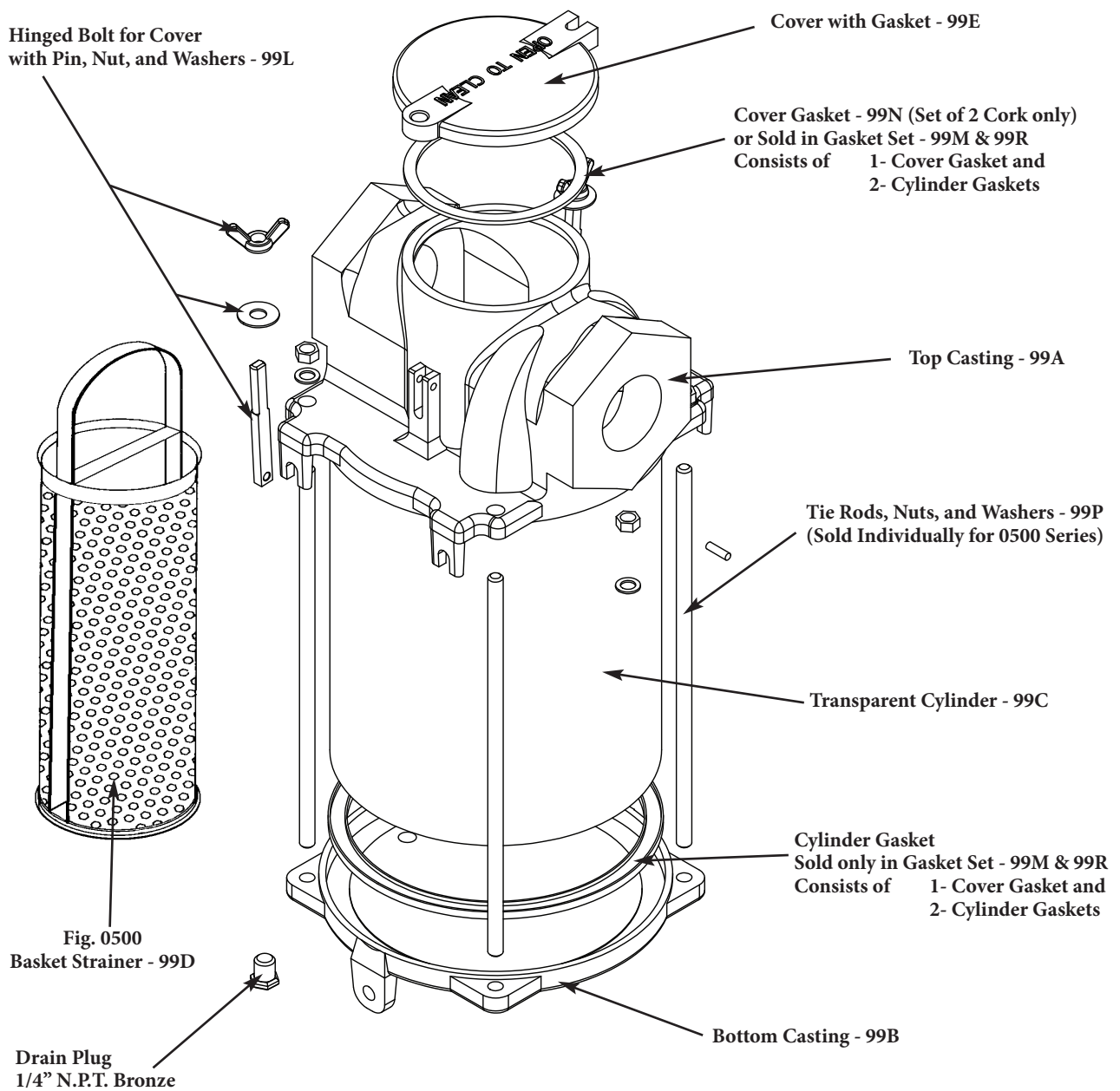

6 Underwater Hardware

### Spare Parts Ordering Information

For Spare Part No. Insert a Spare Part Code Listed Below in Place of the "PLB" in the Strainer's Catalog Number (i.e., 050000999A, Top Casting for 2" (#9) Strainer).

Description	Spare Part Code	Sample Part Number	Package	Description	Spare Part Code	Sample Part Number	Package
Top Casting	99A	050000999A	Boxed	Cork Gasket Kit Consists of:			
Bottom Casting	99B	050000999B	Boxed	1- Cover Gasket and			
Transparent Cylinder	99C	050000999C	Boxed	2- Cork Cylinder Gaskets	99M*	0500DP999M	Bag
Basket Strainer	99D	050000999D	Boxed	Rubber Gasket Kit Consists of:			
Cover with Gasket	99E	050000999E	Boxed	1- Cover Gasket and			
Hinged Bolt for Cover				2- Rubber Cylinder Gaskets	99R*	0500DP999R	Bag
With Pin, Nut and Washer	99L	0500DP999L	Bag	Tie Rods, Nuts, and Washers			
Cork Cover Gasket Kit (Set of 2)	99N	0500DP999N	Bag	Consists of (1 Each for 0500 Series)	99P	0500DP999P	Bag

\* Note: Older model strainers utilizing cork cylinder gaskets must order 99M Cork Gasket Kit and newer model strainers must order 99R Rubber Gasket Kit.

## Underwater Hardware Packaging and Thread Styles

These durable little tags have everything a retailer needs to showcase products and ring up sales. On each tag you will find the Perko name colorfully printed in blue, our figure number, a product description and the bar code for your scanner. There is even a California Proposition 65 statement (where applicable) on the back. These tags are designed to securely hold on to the product and hang from your standard peg hooks. And since the tags are small, you can also simply toss them into a bulk bin if you prefer. Either way, the tags will stay attached, unlike stickers that fall off bronze parts. These tags are available on thru hulls, adapters and several types of strainers. Look for the "DP" designation. Our "DP" Dealer Package for small items (like the smaller thru hull fittings and tailpieces) will be a 5 or 10 piece bulk box with a bar code label on each individual unit.

**THESE 5 OR 10 PIECE CARTONS CANNOT BE BROKEN.** Larger items (like valves & strainers) will be available individually boxed as a single unit standard package with a barcode label on the outside of the box.

To be sure the parts you receive are barcoded for Retail Sale, order either a "DP" version or a single unit standard package.



All of our small repair/replacement strainer parts are now barcoded. Top Castings (99A), Bottom Castings (99B), Transparent Cylinders (99C), Strainer Baskets (99D) and Covers (99E) are available individually boxed as barcoded single unit standard packages. Smaller items or kits including Cover Hardware Kits (99L), Gasket Kits (99M & 99R) and Tie Rod Kits (99P) are individually packaged as "DP" items in bags with a barcode label.

6 Underwater Hardware

## UNDERSTANDING UNDERWATER HARDWARE PIPE THREAD STYLES

### Straight Pipe Threads (NPS)

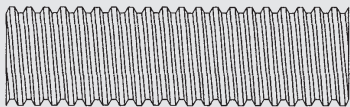

Straight pipe threads are used where connections are purely mechanical and/or bedding compounds are generally used. The intake side of all seacocks, thru-hulls, and scuppers with hose barbs, and all flanged lock nuts use straight threads.

### Tapered Pipe Threads (NPT)

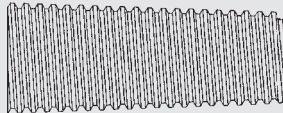

Tapered pipe threads are used where connections must also be watertight. The output side of seacocks, in-line valves, hose adapters, drain plugs, raw water, and pump strainers use tapered threads.

### Combination Tapered/Straight Pipe Threads (NPT/S)

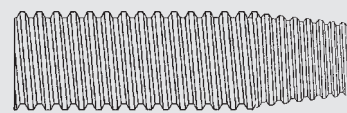

On all other thru-hulls, scuppers and intake strainers we use a unique combination pipe thread. The first few threads are tapered. The rest remain straight threads. This approach allows the same thru-hull to seal when coupled with an in-line valve or to engage at various depths when connected to a seacock.



## Strainers

### Intake Strainer

Material: Cast Bronze  
 For Pipe Sizes: 1/2" to 1-1/4" NPT/S (See Page 96)  
 Screw Size: #8  
 Features: Machined Slots

Max. Pipe Size	Max. Hull Thickness	Dimensions Strainer	Retail Pkg.	OEM Bulk Pkg.
1/2"	2-1/4"	3" x 4"	0065DP4PLB	0065004PLB
3/4"	2-3/16"	3" x 4"	0065DP5PLB	0065005PLB
1"	2-1/2"	3" x 4"	0065DP6PLB	0065006PLB
1-1/4"	3"	3-1/4" x 4-1/4"	0065DP7PLB	0065007PLB

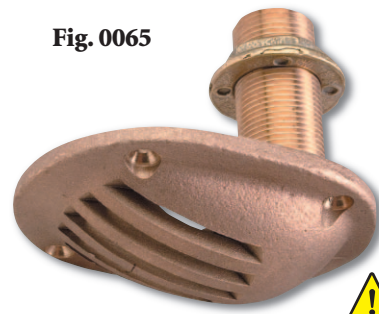

Fig. 0065



**PROP 65 WARNING**  
 (Contains Lead)

### Scoop Strainer

Material: Cast Bronze  
 For Thru Hull: Sizes: 3/8" to 2"  
 Screw Size: #8  
 Features: Machined Slots

For Thru-Hull Sizes	Dimensions Strainer	Retail Pkg.	Standard Pkg.
3/8" & 1/2"	3-1/2" x 2-1/2"	0066DP1PLB	0066001PLB
3/4" & 1"	5" x 3-1/4"	0066DP2PLB	0066002PLB
1-1/4" & 1-1/2"	6-1/4" x 4-1/4"	0066DP3PLB	0066003PLB
2"	8" x 5-1/8"	0066DP4PLB	0066004PLB



Fig. 0066



**PROP 65 WARNING**  
 (Contains Lead)

### Round Strainer

Material: Cast Bronze  
 For Thru Hull: Sizes: 3/8" to 3"  
 Screw Size: Sizes 1-5: #8  
 Sizes 6 & 7: #10  
 Features: Drilled Holes

For Thru-Hull Size	O.D.	I.D.	Retail Pkg.	Standard Pkg.
3/8" & 1/2"	2-1/2"	1-5/8"	0086DP1PLB	0086001PLB
3/4"	3"	2"	0086DP2PLB	0086002PLB
1"	3-1/2"	2-3/8"	0086DP3PLB	0086003PLB
1-1/4" & 1-1/2"	4"	3"	0086DP4PLB	0086004PLB
2"	5"	3-3/4"	0086DP5PLB	0086005PLB
2-1/2"	6"	4-1/2"	-----	0086006PLB
3"	8"	6-1/4"	-----	0086007PLB



Fig. 0086



**PROP 65 WARNING**  
 (Contains Lead)

### Pump Strainers - For Hose or Pipe

Material: Cast Bronze  
 Uses: For Hose: Fig. 0709  
 For Pipe (NPT): Figs. 0721 & 0722  
 (See Page 96)



Fig. 0709

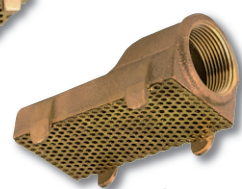

Fig. 0721

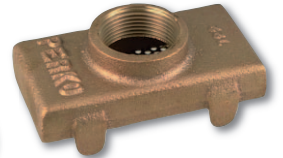

Fig. 0722

Hose Size	Pipe Size	Length Overall	Width Overall	Dealer Pkg.	Standard Pkg.
5/8"	-----	3-5/8"	1-3/4"	0709DP0PLB	-----
-----	1-1/4"	4-3/4"	2-3/4"	-----	0721000PLB
-----	1-1/4"	4-1/2"	2-3/4"	-----	0722000PLB

**Spare Parts Ordering Information**  
 Screen for: Fig 0709: 070900088A  
 Fig 0721: 072100088A  
 Fig 0722: 072200088A

**PROP 65 WARNING**  
 (Contains Lead)

Underwater Hardware

## Seacocks

### Seacocks - Ball Valve Design

- Material: Cast Bronze  
 Finish: Plain  
 For Hose Sizes: 3/4" to 3"  
 For Pipe Sizes: 3/4" to 3" NPS (Base) (See Page 96)  
 Features:
- Polymer Ball and Seat, Assuring a Tight Seal and Ease of Operation, and Drain Plugs for Winterizing
  - Handles are Easily Removed
  - Fig. 0834: With 90° Curved Hose Adapter
  - Fig. 0835: With Straight Hose Adapter



Fig. 0834

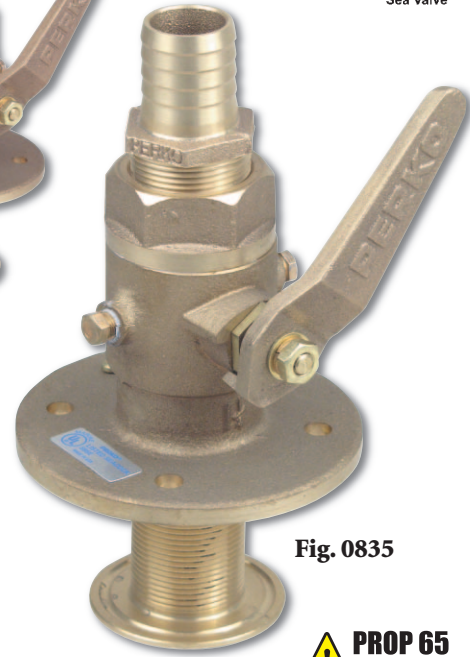

Fig. 0835



Hose Size	Pipe Size	Flange Dia.	Fig. 0834 Overall Height*	Fig. 0834 Std. Pkg.	Fig. 0835 Overall Height*	Fig. 0835 Std. Pkg.	Bolt Size
3/4"	3/4"	3-1/4"	5-7/8"	0834005PLB	5"	0835005PLB	5/16"
1"	1"	4-3/8"	6-3/8"	0834006PLB	5-3/8"	0835006PLB	3/8"
1-1/4"	1-1/4"	4-7/8"	7-5/8"	0834007PLB	6-1/4"	0835007PLB	3/8"
1-1/2"	1-1/2"	5-1/2"	8-3/8"	0834008PLB	6-5/8"	0835008PLB	3/8"
2"	2"	5-3/4"	10-3/8"	0834009PLB	7-7/8"	0835009PLB	3/8"
2-1/2"	2-1/2"	7-1/4"	12-1/2"	0834010PLB	10-3/8"	0835010PLB	1/2"
3"	3"	8"	14-3/8"	0834011PLB	12"	0835011PLB	1/2"

\* Overall Height is measured from the top of the hose adapter to the bottom of the flange.

### Seacock Body - Ball Valve Design

- Material: Cast Bronze  
 For Pipe Sizes: 3/4" to 3" NPS (Base) and NPT (Top) (See Page 96)  
 Features:
- Polymer Ball and Seat, Assuring a Tight Seal and Ease of Operation, and Drain Plugs for Winterizing
  - Handles are Easily Removed
  - These Valve Bodies are Offered to Meet the Needs of Applications that Require Extra Long, Scoop or Flush Type Thru-Hulls.

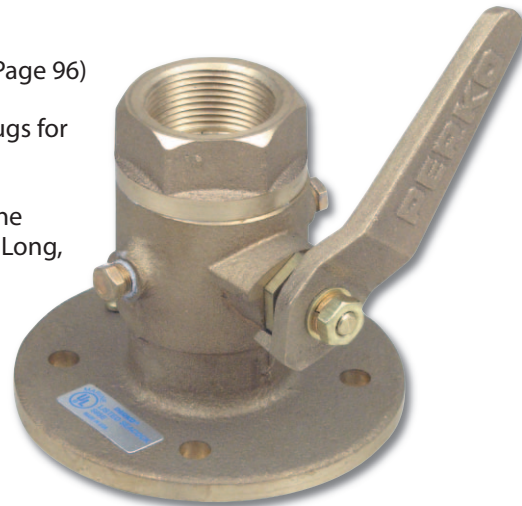

Fig. 0805



Pipe Size	Flange Diameter	Overall Height	Fig. 0805 Standard Pkg.	Bolt Size
3/4"	3-1/4"	3-3/8"	0805005PLB	5/16"
1"	4-3/8"	3-3/4"	0805006PLB	3/8"
1-1/4"	4-7/8"	4-1/4"	0805007PLB	3/8"
1-1/2"	5-1/2"	4-1/2"	0805008PLB	3/8"
2"	5-3/4"	5-3/4"	0805009PLB	3/8"
2-1/2"	7-1/4"	7-1/2"	0805010PLB	1/2"
3"	8"	7-3/4"	0805011PLB	1/2"

\* Overall Height is measured from the top of the valve body to the bottom of the flange.

#### Spare Parts Ordering Information

The Repair Kits Listed Below Consist of: 1 Ball, 2 Ball Seats and 2 O-Rings for the Valve Stem.

Pipe Size	Repair Kit Part No.	Pipe Size	Repair Kit Part No.	Handle Size	Part No.
3/4"	080500599B	2-1/2"	080501099B	Size 7	080500799D
1"	080500699B	3"	080501199B	Size 8	080500899D
1-1/4"	080500799B			Size 9	080500999D
1-1/2"	080500899B	Handle Part No.		Size 10	080501099D
2"	080500999B	Size 5	080500599D	Size 11	080501199D
		Size 6	080500699D		

6 Underwater Hardware

## Pipe to Hose Adapters

### Pipe to Hose Adapter - 90° Curved

Material: Cast Bronze  
 For Pipe Sizes: 3/4" to 3" NPT (See Page 96)  
 Features: Cast Hex for Easier Installation



Fig. 0063

Pipe Size	Hose Size	Length Overall	Retail Pkg.	Standard Pkg.	OEM Bulk Pkg.
3/4"	3/4"	4-1/2"	0063DP5PLB	-----	0063005PLB
1"	1"	4-3/4"	0063DP6PLB	-----	0063006PLB
1-1/4"	1-1/4"	5-1/2"	0063DP7PLB	-----	0063007PLB
1-1/2"	1-1/2"	6"	0063DP8PLB	-----	0063008PLB
2"	2"	7"	-----	0063009PLB	-----
2-1/2"	2-1/2"	8-1/2"	-----	0063010PLB	-----
3"	3"	10"	-----	0063011PLB	-----

NOTE: The Above Item Meets the Requirements of U.S.C.G. Safety Standards, January 31, 1977 for Gasoline Fuel Systems, 33 CFR 183.



### Pipe to Hose Adapter - Straight

Material: Cast Bronze  
 For Pipe Sizes: 1/2" to 3" NPT (See Page 96)  
 Features:
 

- Cast Hex for Easier Installation
- Precision Machined Hose Barb

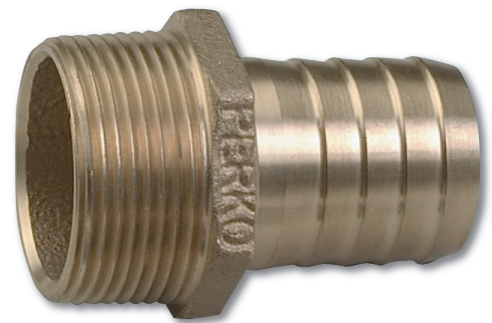

Fig. 0076

Pipe Size	Hose Size	Length Overall	Retail Pkg.	Standard Pkg.	OEM Bulk Pkg.
1/2"	5/8"	1-5/8"	0076DP4PLB	-----	0076004PLB
3/4"	3/4"	1-3/4"	0076DP5PLB	-----	0076005PLB
1"	1"	1-3/4"	0076DP6PLB	-----	0076006PLB
1-1/4"	1-1/4"	2"	0076DP7PLB	-----	0076007PLB
1-1/2"	1-1/2"	2-1/4"	0076DP8PLB	-----	0076008PLB
2"	2"	2-5/8"	-----	0076009PLB	0076009PLB
2-1/2"	2-1/2"	4"	-----	0076010PLB	-----
3"	3"	4-3/4"	-----	0076011PLB	-----

NOTE: The Above Item Meets the Requirements of U.S.C.G. Safety Standards, January 31, 1977 for Gasoline Fuel Systems, 33 CFR 183.



## Thru-Hull Connections

### Thru-Hull Connection for Use with Hose\*

- Material: Cast Bronze  
 Finish: Chrome Plated or Plain  
 For Hose Sizes: 5/8" to 2"  
 Max. Hull Thickness: Up To 2"  
 Features:
- Flange is Machined to Fit Hull and Grooved to Retain Bedding Compound.
  - Neck is Threaded to Approximately 3/16 Inch From Flange.

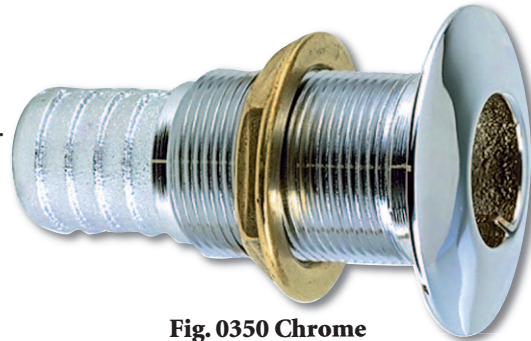

Fig. 0350 Chrome

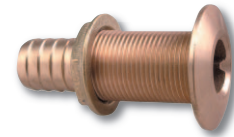

Fig. 0350 Plain



Illustration Of Bedding Groove

Hose Size	Mounting Hole Dia.	Max. Hull Thickness	O.D. Flange	Plain Bronze		Chrome Plated Bronze	
				Retail Pkg.	OEM Bulk Pkg.	Retail Pkg.	OEM Bulk Pkg.
5/8"	13/16"	1-1/16"	1-1/2"	0350004DPP	0350004PLB	0350004DPC	0350004CHR
3/4"	1"	1-5/8"	1-7/8"	0350005DPP	0350005PLB	0350005DPC	0350005CHR
1"	1-5/16"	1-3/4"	2-1/4"	0350006DPP	0350006PLB	0350006DPC	0350006CHR
1-1/8"	1-5/16"	1-3/4"	2-1/4"	035006ADPP	035006APLB	035006ADPC	035006ACHR
1-1/4"	1-5/8"	1-7/8"	2-3/4"	0350007DPP	0350007PLB	0350007DPC	0350007CHR
1-1/2"	1-7/8"	1-7/8"	3-1/8"	0350008DPP	0350008PLB	0350008DPC	0350008CHR
2"	2-3/8"	2"	3-3/4"	-----	0350009PLB	-----	0350009CHR

Spare Flanged Nut See Fig. 0075, on page 105.

\*NOTE: Thru-Hull Connections For Use With Hose Are Not Recommended For Use Below The Waterline Per A.B.Y.C. "Safety Standards For Small Craft" Section H-27.



### Thru-Hull Connection for Use with Pipe - Flush Mount

- Material: Cast Bronze  
 Finish: Plain  
 For Pipe Sizes: 1/2" to 2" NPT/S (See Page 96)  
 Max. Hull Thickness: Up To 3-3/8"  
 Features: The exterior surface of the flange is machined flat and designed to be countersunk into the hull, resulting in a smooth external fit with no raised portion to increase drag.

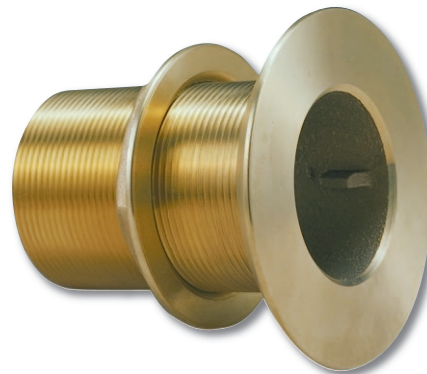
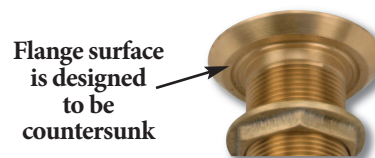

Fig. 0331

Pipe Size	Mounting Hole Dia.	Max. Hull Thickness	O.D. Flange	Retail Pkg.	OEM Bulk Pkg.
1/2"	13/16"	2-3/16"	1-11/16"	0331DP4PLB	0331004PLB
3/4"	1"	2-3/8"	2"	0331DP5PLB	0331005PLB
1"	1-5/16"	2-9/16"	2-1/4"	0331DP6PLB	0331006PLB
1-1/4"	1-5/8"	2-15/16"	2-7/8"	0331DP7PLB	0331007PLB
1-1/2"	1-7/8"	3-1/16"	2-31/32"	0331DP8PLB	0331008PLB
2"	2-3/8"	3-3/8"	3-7/8"	-----	0331009PLB

Spare Flanged Nut See Fig. 0075, on page 105.



## Thru-Hull Connections

### Thru-Hull Connection for Use with Pipe - Extra Long

- Material: Cast Bronze  
 Finish: Plain  
 For Pipe Sizes: 3/4" to 2-1/2" NPT/S (See Page 96)  
 Max. Hull Thickness: Up To 5"  
 Features:
- Flange is Machined to Fit Hull and Grooved to Retain Bedding Compound.
  - Neck is Threaded to Approximately 3/8 Inch From Flange.

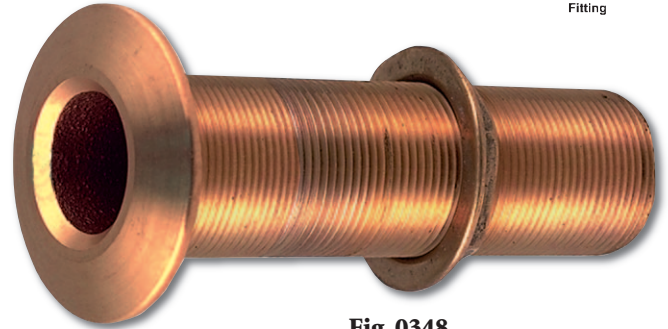

Fig. 0348

Pipe Size	Mounting Hole Dia.	Max. Hull Thickness	O.D. Flange	Retail Pkg.	OEM Bulk Pkg.
3/4"	1"	5"	1-7/8"	0348DP5PLB	0348005PLB
1"	1-5/16"	4-7/8"	2-1/4"	0348DP6PLB	0348006PLB
1-1/4"	1-5/8"	4-5/8"	2-3/4"	0348DP7PLB	0348007PLB
1-1/2"	1-7/8"	4-5/8"	3"	0348DP8PLB	0348008PLB
2"	2-3/8"	4-1/2"	3-5/8"	-----	0348009PLB
2-1/2"	2-7/8"	4-1/4"	4-5/16"	-----	0348010PLB

Spare Flanged Nut See Fig. 0075, on page 105.



Illustration Of Bedding Groove



### Thru-Hull Connection for Use with Pipe

- Material: Cast Bronze  
 Finish: Plain  
 For Pipe Sizes: 3/8" to 3" NPT/S (See Page 96)  
 Max. Hull Thickness: Up To 2-3/4"  
 Features:
- Flange is Machined to Fit Hull and Grooved to Retain Bedding Compound.
  - Neck is Threaded to Approximately 3/8 Inch From Flange.

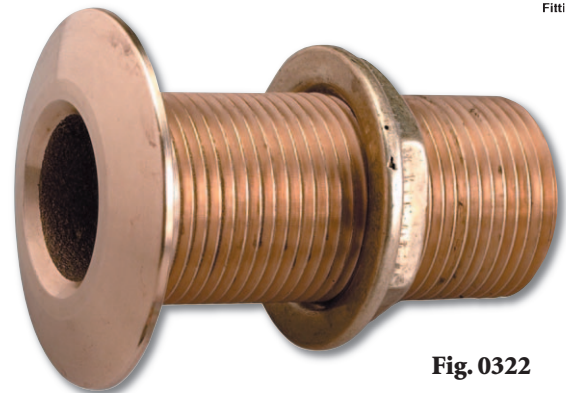

Fig. 0322

Pipe Size	Mounting Hole Dia.	Max. Hull Thickness	O.D. Flange	Dealer Pkg.	Standard Pkg.	OEM Bulk Pkg.
3/8"	11/16"	1-3/4"	1-7/16"	0322DP3PLB	-----	0322003PLB
1/2"	13/16"	1-3/8"	1-1/2"	0322DP4PLB	-----	0322004PLB
3/4"	1"	1-1/2"	1-7/8"	0322DP5PLB	-----	0322005PLB
1"	1-5/16"	1-7/8"	2-3/16"	0322DP6PLB	-----	0322006PLB
1-1/4"	1-5/8"	2"	2-3/4"	0322DP7PLB	-----	0322007PLB
1-1/2"	1-7/8"	2-1/4"	3"	0322DP8PLB	-----	0322008PLB
2"	2-3/8"	2-3/8"	3-5/8"	-----	0322009PLB	0322009PLB
2-1/2"	2-7/8"	2-5/8"	4-1/2"	-----	0322010PLB	-----
3"	3-1/2"	2-3/4"	5"	-----	0322011PLB	-----

Spare Flanged Nut See Fig. 0075, on page 105.



Illustration Of Bedding Groove



## Thru-Hull Connections

### Thru-Hull Connection for Use with Hose\*

Material: Molded Polymer  
 Finish: White or Black  
 For Hose Sizes: 1/2" to 1-1/2"  
 Max. Hull Thickness: Up to 1-7/8"  
 Features: Narrow Flange



**Fig. 0301**  
White

Hose Size	Mounting Hole Dia.	Max. Hull Thickness	O.D. Flange	White Retail Pkg.	White OEM Bulk Pkg.	Black OEM Bulk Pkg.
1/2"	13/16"	1-1/4"	1-1/4"	0301DP4	0301004	0301004BLK
5/8"	13/16"	1-1/4"	1-1/4"	0301DP4A	030104A	030104ABLK
3/4"	1"	1-7/16"	1-1/2"	0301DP5	0301005	0301005BLK
1"	1-5/16"	1-1/2"	1-7/8"	0301DP6	0301006	0301006BLK
1-1/8"	1-5/16"	1-1/2"	1-7/8"	0301DP6A	030106A	030106ABLK
1-1/2"	1-7/8"	1-7/8"	2-1/2"	0301DP8	0301008	0301008BLK



**Black**

Spare Flanged Nut See Fig. 0326 on Page 105.

### Thru-Hull Connection for Use with Hose\*

Material: Molded Polymer  
 Finish: White or Black  
 For Hose Sizes: 1/2" to 1-1/2"  
 Max. Hull Thickness: Up to 1-7/8"  
 Features: Broad Flange



**Fig. 0328**  
White

Hose Size	Mounting Hole Dia.	Max. Hull Thickness	O.D. Flange	White Retail Pkg.	White OEM Bulk Pkg.	Black OEM Bulk Pkg.
1/2"	13/16"	1-1/4"	1-1/2"	0328DP4	0328004	0328004BLK
5/8"	13/16"	1-1/4"	1-1/2"	0328DP4A	032804A	032804ABLK
3/4"	1"	1-7/16"	1-7/8"	0328DP5	0328005	0328005BLK
1"	1-5/16"	1-1/2"	2-1/4"	0328DP6	0328006	0328006BLK
1-1/8"	1-5/16"	1-1/2"	2-1/4"	0328DP6A	032806A	032806ABLK
1-1/2"	1-7/8"	1-7/8"	3"	0328DP8	0328008	0328008BLK



**Black**

Spare Flanged Nut See Fig. 0326 on Page 105.

\*NOTE: Thru-Hull Connections For Use With Hose Are Not Recommended For Use Below The Waterline Per A.B.Y.C. "Safety Standards For Small Craft" Section H-27.



## Thru-Hull Scuppers

### Adjustable Thru-Hull Scupper

Material: Molded Polymer, Recessed Soft Black Flapper  
 Finish: White  
 Surface Thickness: 2" to 4-3/4"  
 Features: Female portion of scupper can be cut down by one rib for each 1/4 inch difference between hull thickness and 4-3/4 inches.

I.D.	Mounting Hole Dia.	O.D. Flange	Retail Pkg.	OEM Bulk Pkg.
1-11/32"	1-13/16"	2-15/16"	0343DP	0343

Spare Flapper: 0333DP099A

Fig. 0343

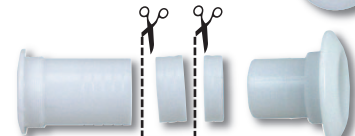

Illustration shows sections of ribs cut out to adjust for various surface thicknesses.

**! PROP 65 WARNING**  
(Contains DINP)

### Transom Mount - Thru-Hull Scupper for Use with Hose\*

Material: Molded Polymer, Recessed Soft Black Flapper  
 Finish: White  
 For Hose Sizes: 1-1/2"  
 Max. Hull Thickness: Up To 2-1/8"  
 Features: Nut and Mounting Hardware Included

Mounting Hole Dia.	O.D. Flange	Retail Pkg.	OEM Bulk Pkg.
1-7/8"	2-7/8"	0323DP	0323

Spare Flanged Nut See Fig. 0326, on page 105. Spare Flapper: 0323DP099A



Fig. 0323

**! PROP 65 WARNING**  
(Contains DINP)

### Transom Mount - Thru-Hull Scupper for Use with Hose\*

Material: Molded Polymer, Recessed Soft Black Flapper  
 Finish: White  
 For Hose Sizes: 1-1/2"  
 Max. Hull Thickness: Up To 3-1/4"  
 Features: Nut and Mounting Hardware Included

Mounting Hole Dia.	O.D. Flange	OEM Bulk Pkg.
1-7/8"	2-7/8"	0327

Spare Flanged Nut See Fig. 0326, on page 105. Spare Flapper: 0323DP099A



Fig. 0327

**! PROP 65 WARNING**  
(Contains DINP)

### Transom Mount - Thru-Hull Scupper for Use with Hose\*

Material: Molded Polymer, Recessed Soft Black Flapper  
 Finish: White  
 For Hose Sizes: 1-1/2"  
 Max. Hull Thickness: Up To 2-1/8"  
 Features: Nut Included

Mounting Hole Dia.	O.D. Flange	Retail Pkg.	OEM Bulk Pkg.
1-7/8"	3"	0333DP	0333

Spare Flanged Nut See Fig. 0326, on page 105. Spare Flapper: 0333DP099A

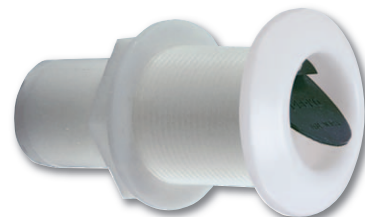

Fig. 0333

**! PROP 65 WARNING**  
(Contains DINP)

\*NOTE: Thru-Hull Connections For Use With Hose Are Not Recommended For Use Below The Waterline Per A.B.Y.C. "Safety Standards For Small Craft" Section H-27.

## Scuppers & Shower Drain

### Thru-Hull Scupper for Use with Hose

- Material: Cast Bronze with Recessed Flapper  
 Finish: Plain or Chrome Plated  
 For Hose Sizes: 1-1/2" & 2"  
 Features:
- "A" Style for thinner hull thickness
  - "B" Style for greater hull thickness
  - Flange is machined to fit hull and grooved to retain bedding compound



Illustration Of Bedding Groove

Finish	Hose Size	Mounting Hole Dia.	Max. Hull Thickness	O.D. Flange	OEM Bulk Pkg.
Chrome	1-1/2"	1-7/8"	1-3/4"	3-1/8"	0377A08CHR
Plain	1-1/2"	1-7/8"	1-3/4"	3-1/8"	0377A08PLB
Chrome	2"	2-3/8"	2"	3-3/4"	0377A09CHR
Chrome	1-1/2"	1-7/8"	3"	3-1/8"	0377B08CHR
Plain	1-1/2"	1-7/8"	3"	3-1/8"	0377B08PLB



Fig. 0377A Chrome

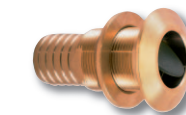

Fig. 0377A Plain



Fig. 0377B Plain & Chrome

Spare Flanged Nut See Fig. 0075, on page 105, Spare Flapper: 0333DP099A

NOTE: The Above Thru-Hull Connections For Use With Hose Are Not Recommended For Use Below The Waterline Per A.B.Y.C. "Safety Standards For Small Craft" Section H-27.



### In Hose Scupper Valve - A NEW Approach

- Material: Polymer Body and Flapper  
 Finish: Blue Body with Black Flapper Valve  
 For Hose Size: 1-1/2" and 2"  
 Installation:
- Mounts inside standard 1-1/2" or 2" hose
  - Simple replacement (if needed)



Fig. 0345 for 1-1/2" Hose (Shown)

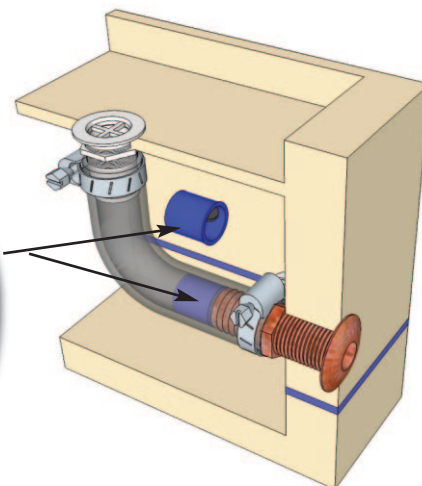

Illustration of In-Line Scupper Valve Installed

Hose Connection	Length	Width	Retail Pkg.	OEM Bulk Pkg.
1-1/2"	1-1/4"	1-9/16" Dia.	0345DP	0345
2"	1-1/4"	1-15/16" Dia.	0345DP2	0345002

### Flush Mount Drain for Use with Pipe

- Material: Cast Bronze with Brass Screen  
 Finish: Chrome Plated  
 For Pipe Sizes: 3/4" & 1-1/4" NPT/S (See Page 96)

The exterior surface of the flange is machined flat and designed to be countersunk into the hull, resulting in a smooth external fit.



Pipe Size	Mounting Hole Dia.	Maximum Thickness	O.D. Flange	Standard Pkg.
3/4"	1"	2-3/8"	2"	0361005CHR
1-1/4"	1-5/8"	2-15/16"	2-7/8"	0361007CHR

Fig. 0361



Spare Flanged Nut See Fig. 0075, on page 105

## Scuppers and Spare Flanged Nuts

### Cockpit Scupper for Use with Hose

For Use When Discharge is Below the Waterline

Material: Cast Bronze with Rubber Check Ball  
 Finish: Plain or Chrome Plated  
 For Hose Sizes: 1" & 1-1/2"  
 Angle of Outlet: 45°  
 Screw Size: #8  
 Features: Deck Key Included



Chrome

Hose Size	O.D. Grate	O.D. Flange	Plain Bronze Standard Pkg.	Chrome Bronze Standard Pkg.
1"	1-13/16"	3-1/4"	0142001PLB	0142001CHR
1-1/2"	2-1/4"	3-5/8"	0142002PLB	0142002CHR

Spare Parts Ordering Information				
Hose Size	Plain Bronze Grate	Chrome Plated Bronze Grate	Check Ball Only	Spare Key Only
1"	0142P0199A	0142C0199A	014200199B	12487-8DP
1-1/2"	0142P0299A	0142C0299A	014200299B	12487-8DP

Fig. 0142  
Plain



### Flush Mount Cockpit Scupper for Use with Hose

For Use When Discharge is Above the Waterline

Material: Molded Polymer  
 Finish: White  
 For Hose Sizes: 1-1/2"  
 Max. Hull Thickness: Up To 1-3/4"  
 Features: Insert Prevents Passage of Large Objects Without Restricting Water Flow



Fig. 0285

Hose Size	O.D. Flange	I.D.	Retail Pkg.	OEM Bulk Pkg.
1-1/2"	2-3/4"	1-1/2"	0285DP	0285

Spare Flanged Nut See Fig. 0326, Below

### Flush Mount Cockpit Scupper for Use with Hose

Material: Molded Polymer with Soft Black Flapper  
 Finish: White  
 Screw Size: #6



Fig. 0365

O.D. Flange	Retail Pkg.	OEM Bulk Pkg.
2-7/8"	0365DP	0365



### Spare Flanged Lock Nuts

Material: Fig. 0075: Cast Bronze  
 Finish: Plain  
 Material: Fig. 0326: Polymer  
 Finish: White or Black



Fig. 0075

Pipe Size	Cast Bronze Retail Pkg.	Wht Polymer Retail Pkg.	Wht Polymer OEM Bulk Pkg.	Blk Polymer OEM Bulk Pkg.
3/8"	0075003DPP	-----	-----	-----
1/2"	0075004DPP	0326DP4	0326004	0326004BLK
3/4"	0075005DPP	0326DP5	0326005	0326005BLK
1"	0075006DPP	0326DP6	0326006	0326006BLK
1-1/4"	0075007DPP	-----	-----	-----
1-1/2"	0075008DPP	0326DP8	0326008	0326008BLK
2"	0075009DPP	-----	-----	-----
2-1/2"	0075010DPP	-----	-----	-----
3"	0075011DPP	-----	-----	-----



Fig. 0326  
White



Fig. 0326  
Black



6  
Underwater Hardware

## Garboard Drain Pugs

### “T” Handle Garboard Drain Plugs

- Material: Cast Bronze  
 Finish: Plain  
 For Pipe Size: 3/4" NPT  
 Installation:
  - Fig. 0266: Mounts on outside surface with 4 screws
  - Fig. 0363: Flush mounts with flanged lock nut



Fig. 0266

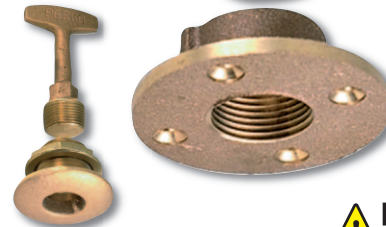

Fig. 0363



Pipe Size	Maximum Hull Thickness	Length Threaded Neck	O.D. Flange	Retail Pkg.	OEM Bulk Pkg.	Screw Size
3/4"	-----	5/8"	2-3/8"	0266DP0PLB	0266000PLB	#8
3/4"	3/4"	1-1/4"	2-3/8"	0363DP0PLB	0363000PLB	-----

Spare Plug: 0370DP0PLB., Nut for Fig. 0363: 0075006DPP

6

Underwater Hardware

### Garboard Drain Plug

- Material: Cast Bronze with Brass Plug  
 Finish: Plain  
 For Pipe Size: 1/2" NPT  
 Screw Size: #8  
 Installation: Mounts on outside surface with 3 screws

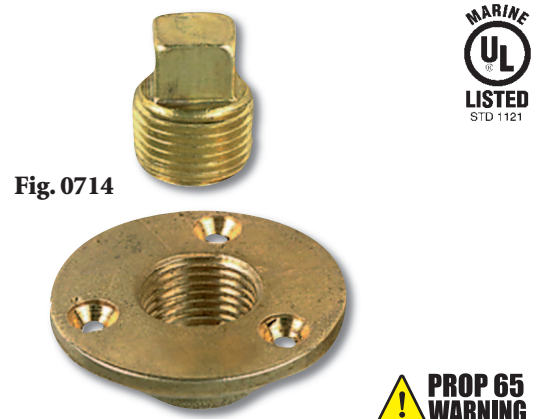

Fig. 0714



Pipe Size	O.D. Flange	Retail Pkg.	OEM Bulk Pkg.
1/2"	2"	0714DP1PLB	0714001PLB

Spare Plug: 0742DP1

### Garboard Drain Plugs

- Material: Cast Bronze Flange with Brass Plug  
 Zinc Plated Square Wrench  
 Finish: Plain  
 For Pipe Size: 1" NPT  
 Wrench Size: 1/2" x 1/2" Square  
 Screw Size: #10  
 Installation: Mounts on outside surface with 4 screws

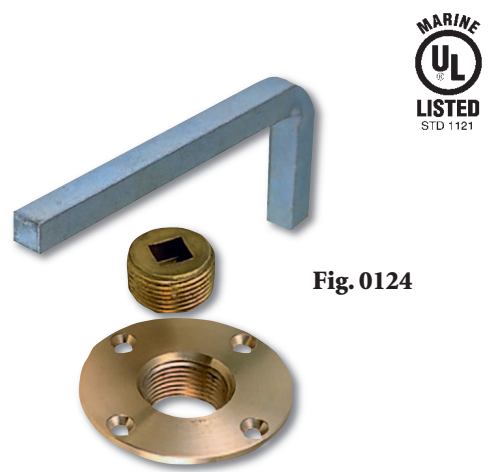

Fig. 0124



Pipe Size	Length Threaded Neck	O.D. Flange	Standard Pkg.
1"	1"	3-1/8"	0124000PLB

**Spare Parts Ordering Information**

Wrench: 012400099A Wrench Size: 1/2" x 1/2"  
 Plug: 012400099B



## Emissions Systems Product Catalog

Look for the PERKO® Emissions Systems Catalog containing the complete line of products for EPA and CARB certified Canister and Pressure Relief fuel system components.

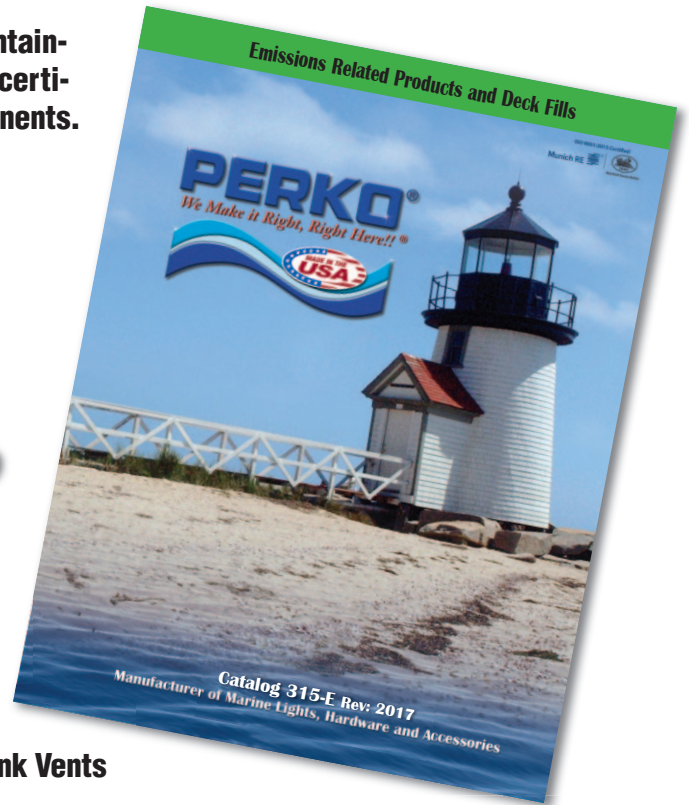

**Fill Limit Valves**



**Tank Vent Valves**



**Inlet Check Valves**



**Tank Vents**



**Pressure Relief Fuel Fills and Caps**



**Carbon Canisters**



**Stanchion Tubes**



**Surge Protector**



**Special Manifolds**

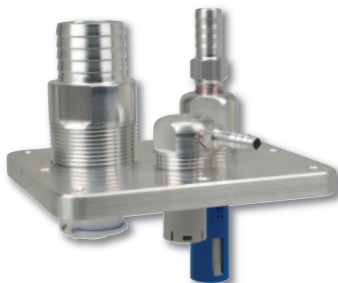

**Air/Fuel Separators**



**P-Traps**



## Inlet Check Valve and Combination Package

### In Hose Inlet Check Valve (ICV)

- Material: Polymer  
 Finish: White body with black flapper valve  
 For Hose Size: 1-1/2" and 2"  
 Installation:
- Mounts inside standard 1-1/2" or 2" fill hose near the connection to the fuel tank
  - Valves are designed for use with plastic or metal tanks
  - Allows for full 18 gpm flow rates

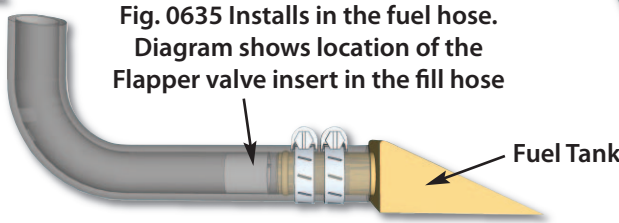

Fig. 0635 for 1-1/2" Hose



Recommended Use	Hose Size	Length	Width	Retail Pkg.	OEM Bulk Pkg.
Gasoline Systems	1-1/2"	1-1/4"	1-9/16" Dia.	0635DP0	0635000
Diesel Systems	2"	1-1/4"	1-15/16" Dia.	0635DP2	0635002

## Reduce Refueling Spills

### Combination package includes Inlet Check Valve and Surge Protector

### Can be used with Gas or Diesel Fuel Systems

Installing an **Inlet Check Valve** in the fill hose and a **Surge Protector** in the vent line can significantly reduce spitback & wellback during the refueling of most boats.

#### Features:

- Reduces fuel surges and backsplash during refueling
- For use with 1-1/2" fill hose and 5/8" vent hose
- Can be used with aluminum or plastic fuel tanks
- Aids in automatic pump shutoff
- Allows unobstructed airflow at fill rates up to 18 gpm

#### Easy to Install:

- Loosen hose clamps
- Remove hose
- Insert valve in hose
- Re-install hose & tighten clamps
- Check for leaks



Single Package



Counter Top Display

Fig. 0635 Inlet Check Valve installs in the fill hose near the fuel tank to reduce wellback through the fill hose.

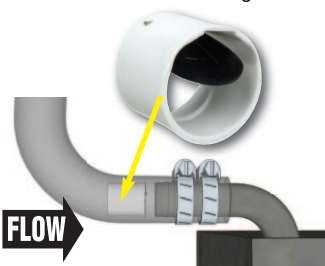
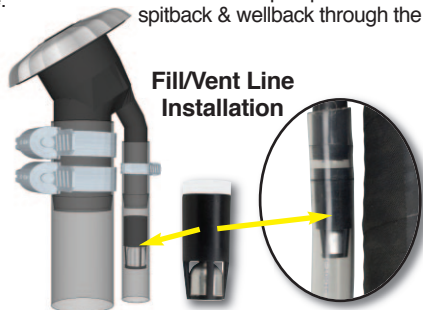

Fig. 0553 Surge Protector installs in the vent line near the fuel fill or a gas tank vent to aid in pump shutoff and reduce spitback & wellback through the vent line.



**Combo Package**  
 Individual Package  
 Counter Top Display with 5 packages

**Retail Pkg.**  
 0030DP0005  
 0030DP5DIS

## P-Traps



### P-Trap

Material: Polymer Body with Aluminum Shaft and Stainless Steel Splash Guard  
 Finish: Black or White Insert  
 For Vent Hose: 5/8" vent line

- Features:
- Allows vapor to vent from tank during thermal expansion of fuel
  - Allows fresh airflow into the tank during thermal contraction of fuel and when engine is running
  - Helps to protect canister and fuel system from water
  - Deflector style vent opening reduces water volume entering assembly
  - Internal P-Trap design helps to prevent water entering into fuel system
  - 90° hose connection (to vent axis)



Fig. 0630

Catalog Number	Vent Line Hose Size	Splash Guard Style	Splash Guard Color	Max. Hull Thickness Inches
0630004BLK	5/8"	Cup	Black	0 to 1"
0630004WHT	5/8"	Cup	White	0 to 1"

Spare Cap Assembly (Splash Guard) Black: 063000499B, White: 063000499W

### P-Traps

Material: Polymer Body and Splash Guard  
 Finish: Black Body with Black or White Splash Guards  
 For Vent Hose: 5/16" or 5/8" vent line connection options

- Features:
- A variety of splash guards options
  - Allows vapor to vent from tank during thermal expansion of fuel
  - Allows fresh airflow into the tank during thermal contraction of fuel and when engine is running
  - Internal P-Trap design helps to protect canister and fuel system from water
  - Deflector style vent opening reduces water volume entering assembly
  - 90° hose connection (to vent axis)
  - 5/8" vent line option provides sufficient airflow for refueling vapors
  - 5/16" version helps reduce system cost by allowing for less expensive, smaller vent lines and hose clamps
  - 5/16" p-trap easily connects to PERKO® canisters with 5/16" hose barsbs

**NEW**  
PRODUCT



Fig. 0632  
Shown: Style 1  
for 5/8" vent hose



Fig. 0632  
Shown: Style 1  
for 5/16" vent hose



Catalog Number	Vent Line Hose Size	Splash Guard Style	Splash Guard Color	Max. Hull Thickness Inches
0632011DPB	5/16"	Style 1	Black	5/8
0632014DPB	5/8"	Style 1	Black	5/8

#### Individual Splash Guard Spare Part Ordering Information

Style 1: Black - Cat. No. 0592B1099A, White - Cat. No. 0592W1099A,  
 Style 2: Black - Cat. No. 0592B2099A, White - Cat. No. 0592W2099A.  
 Style 3: Black - Cat. No. 0592B3099A, White - Cat. No. 0592W3099A.

#### Optional Splash Guards Available in Black or White



Style 1 Mounted

Style 2 Mounted

Style 3 Mounted

## Fuel Tank Vents

### 90° Angled Tank Vent with Swivel Elbow

**Angled Design Allows Elbow to be Rotated to any Position**

- Material: Zinc Alloy Elbow, Polymer Splash Guard  
 Finish: Black or White Splash Guard  
 For Vent Hose: 5/8"  
 Max. Hull Thickness: 5/8"  
 Features:
- Three Styles of Splash Guards
  - Removable 30 Mesh Stainless Steel Wire Screen Flame Arrestor (for use with gasoline applications)



Splash Guard Style	Splash Guard	OEM Bulk Pkg.
Style 1	Black	0592014BLK
Style 1	White	0592014WHT
Style 2	Black	0592024BLK
Style 2	White	0592024WHT
Style 3	Black	0592034BLK
Style 3	White	0592034WHT

**Individual Splash Guard Spare Part Ordering Information**  
 Style 1: Black - Cat. No. 0592B1099A, White - Cat. No. 0592W1099A,  
 Style 2: Black - Cat. No. 0592B2099A, White - Cat. No. 0592W2099A.  
 Style 3: Black - Cat. No. 0592B3099A, White - Cat. No. 0592W3099A.



### Straight or 90° Angled Tank Vent with Swivel Elbow

**Angled Design Allows Elbow to be Rotated to any Position**

- Material: Zinc Alloy Elbow, Stainless Steel Escutcheons with Polymer Splash Guard  
 Finish: Black or White Splash Guard  
 Fig. 0597: Chrome Plated Straight Body  
 Fig. 0598: Plain 90° Elbow Body  
 For Vent Hose: 5/8"  
 Max. Hull Thickness: 5/8"  
 Features: Removable 30 Mesh Stainless Steel Wire Screen Flame Arrestor (for use with gasoline applications)



Style	Splash Guard	Retail Pkg.	OEM Bulk Pkg.
Straight	Black	0597DP4BLK	0597004BLK
Straight	White	0597DP4WHT	0597004WHT
90° Angle	Black	0598DP4BLK	0598004BLK
90° Angle	White	0598DP4WHT	0598004WHT

Spare Splash Guard Cap: Black, Cat. No. 0570B0099A, White, Cat. No. 0570W0099A

**Note: All of the Above Vents are Designed to Meet the Requirements of U.S.C.G. Safety Standards January 31, 1977, for Gasoline Fuel Systems 33 CFR 183.**



## Fuel Tank Vents

### Straight or 90° Angled Tank Vent with Swivel Elbow Angled Design Allows Elbow to be Rotated to any Position

- Material: Zinc Alloy and Polymer  
 Finish: Fig. 0570: Chrome Plated Straight Body with Black or White Splash Guard  
 Fig. 0571: Plain 90° Elbow with Black or White Splash Guard  
 For Vent Hose: 5/8"  
 Max. Hull Thickness: 3/4"
- Features: Removable 30 Mesh Stainless Steel Wire Screen Flame Arrestor (for use with gasoline applications)



Fig. 0570



Fig. 0571



Style	Splash Guard	Retail Pkg.	OEM Bulk Pkg.
Straight	Black	0570DP4BLK	0570004BLK
Straight	White	0570DP4WHT	0570004WHT
90° Angle	Black	0571DP4BLK	0571004BLK
90° Angle	White	0571DP4WHT	0571004WHT

Spare Splash Guard Cap: Black, Cat. No. 0570B0099A, White, Cat. No. 0570W0099A

### Straight or 90° Angled Tank Vent with Swivel Elbow Angled Design Allows Elbow to be Rotated to any Position

- Material: Zinc Alloy and Polymer  
 Finish: Chrome Plated with Black or White Splash Guard  
 Fig. 0506: Chrome Plated Straight Body  
 Fig. 0561: Plain 90° Elbow Body  
 For Vent Hose: 5/8"
- Features: Removable 30 Mesh Stainless Steel Wire Screen Flame Arrestor (for use with gasoline applications)



Fig. 0506



Fig. 0561



Style	Splash Guard	Max. Hull Thickness	Retail Pkg.	OEM Bulk Pkg.
Straight	Black	3/4"	0506DP4CHR	0506004CHR
Straight	White	3/4"	0506DP4WHT	0506004WHT
90° Angle	Black	1"	0561DP4CHR	0561004CHR
90° Angle	White	1"	0561DP4WHT	0561004WHT

Splash Guard Black: Cat. No. 0518000BLK Splash Guard White: Cat. No. 0518000WHT

**Note: All of the Above Vents are Designed to Meet the Requirements of U.S.C.G. Safety Standards January 31, 1977, for Gasoline Fuel Systems 33 CFR 183.**

7  
Deck Plates, Fills, Tank Vents, and Ventilators

## Fuel Tank Vents

### Tank Vent

Material: Bronze  
 Finish: Chrome Plated  
 For Vent Hose: 5/8" or 3/4"  
 Features: Removable 30 Mesh Stainless Steel Wire Screen Flame Arrestor (for use with gasoline applications)

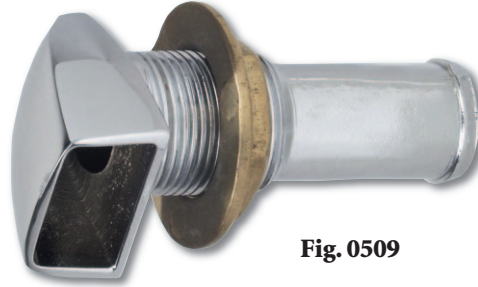

Fig. 0509



Hose Size	Max. Hull Thickness	Retail Pkg.	OEM Bulk Pkg.
5/8"	3/4"	0509DP4CHR	0509004CHR
3/4"	5/8"	0509DP5CHR	0509005CHR

### Tank Vent

Material: Bronze  
 Finish: Chrome Plated  
 For Pipe Size: 3/8" or 1/2" Threads  
 Features: Removable 30 Mesh Stainless Steel Wire Screen Flame Arrestor (for use with gasoline applications)

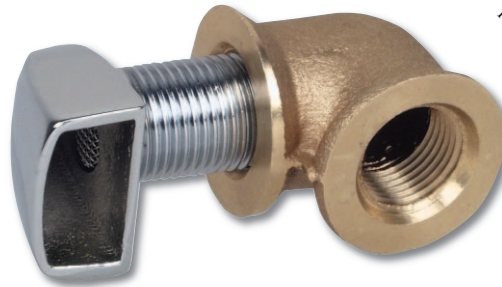

Fig. 0503



Pipe Size	Max. Hull Thickness	Retail Pkg.	OEM Bulk Pkg.
3/8"	7/8"	0503DP3CHR	0503003CHR
1/2"	7/8"	0503DP4CHR	0503004CHR

### Tank Vent

Material: Bronze  
 Finish: Chrome Plated  
 For Pipe Size: 3/8" or 1/2" Threads  
 Features: Removable 30 Mesh Stainless Steel Wire Screen Flame Arrestor (for use with gasoline applications)

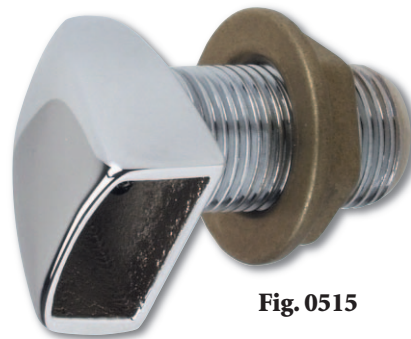

Fig. 0515



Pipe Size	Max. Hull Thickness	Retail Pkg.	OEM Bulk Pkg.
3/8"	5/8"	0515DP3CHR	0515003CHR
1/2"	5/8"	0515DP4CHR	0515004CHR

**Note: All of the Above Vents are Designed to Meet the Requirements of U.S.C.G. Safety Standards January 31, 1977, for Gasoline Fuel Systems 33 CFR 183.**

## Non-EPA Vented and Non-Vented Deck Fills for 1-1/2" Hose

### Gas, Diesel, Water and Waste Deck Fills

Patent Nos. 5,275,213 & 5,327,946

Material:	Bronze Cap, Polymer Body with Stainless Steel Bead Chain (Except for Waste)
Finish:	Chrome Plated Cap with Black Body
Fill Hose Size:	1-1/2"
Vent Hose Size:	5/8"
Ground Wire:	Not Required
Mounting Hole Dia:	2-1/8"
O.D. Flange:	3-3/8"
Screw Size:	#8
Neck Length:	Vented Fills: 2-7/16" Non-Vented Fill: 3-1/8"

- Features:
- Integral Tank Vent with Anti Surge Valve
  - Flame Arrestor (on gas and diesel only)
  - Deck Plate Key and O-Ring Included

Fig. 0540: Angled Neck, Vented Fill

Fig. 0541: Straight Neck, Vented Fill

Fig. 0557: Straight Neck, Non-Vented Fill

Fig. 0556: Straight Neck, Non-Vented For Waste



Fig. 0540  
Shown

Type	Neck	Retail Pkg.	OEM Bulk Pkg.
<b>Vented</b>			
Gas <sup>2</sup>	Angled	0540DPGCHR <sup>1</sup>	0540G00CHR <sup>1</sup>
Diesel <sup>2</sup>	Angled	0540DPDCHR	0540D00CHR
Water	Angled	0540DPWCHR	0540W00CHR
Gas <sup>2</sup>	Straight	0541DPGCHR <sup>1</sup>	0541G00CHR <sup>1</sup>
Diesel <sup>2</sup>	Straight	0541DPDCHR	0541D00CHR
Water	Straight	0541DPWCHR	0541W00CHR
<b>Non-Vented</b>			
Gas <sup>2</sup>	Straight	0557DPGCHR <sup>1</sup>	0557G00CHR <sup>1</sup>
Diesel <sup>2</sup>	Straight	0557DPDCHR	0557D00CHR
Water	Straight	0557DPWCHR	0557W00CHR
Waste <sup>3</sup>	Straight	0556DP0CHR	0556000CHR



Fig. 1247

#### Vented Style Fills



Fig. 0540

Fig. 0541

Gas, Diesel or Water Options



Fig. 0540DPRBLK<sup>2</sup>  
Mounting Ring

#### Non-Vented Style Fills



Fig. 0557

Fig. 0556

Gas, Diesel or  
Water Options

Waste<sup>3</sup>

<sup>1</sup>NOTE: These Items Meet the Requirements of U.S.C.G. Safety Standards, January 31, 1977, for Gasoline Fuel Systems, 33 CFR 183. Fills shown on this page **DO NOT** meet the requirements for 40 CFR 1060 sub part B Emissions Standards and Related Requirements.

#### Spare Parts Ordering Information

Gas Cap, O-Ring & Retainer: 0540DPG99A  
 Diesel Cap, O-Ring & Retainer: 0540DPD99A  
 Water Cap, O-Ring & Retainer: 0540DPW99A  
 Waste Cap with O-Ring: 0556DP099A  
 Deck Plate Key: 1247DP0BLK  
 O-Ring Only: 054000099B

<sup>2</sup>Note: Consider using the Mounting Ring for all installations. Retail package includes mounting ring. See Page 122.

<sup>3</sup>NOTE: Fig. 0556 Complies with Adopted Standards on "Fittings" A.B.Y.C. Recommended Practices Standards Covering Sewage Holding and/or Treatment Devices for Marine Waste Systems.



Deck Plates, Fills, Tank Vents, and Ventilators

## Non-EPA Vented and Non-Vented Deck Fills for 1-1/2" Hose with Metallic Insert

### Gas, Diesel, Water and Waste Deck Fills

Patent Nos. 5,275,213 & 5,327,946

- Material: Scalloped Bronze or Stainless Steel Cap, Metallic Insert, Polymer Body and Tether
- Finish: Chrome Plated or Polished Cap with Black Body and Tether
- Fill Hose Size: 1-1/2"
- Vent Hose Size: 5/8"
- Ground Wire: Not Required
- Mounting Hole Dia: 2-1/8"
- O.D. Flange: 3-3/8"
- Screw Size: #8
- Neck Length: Vented Fills: 2-7/16"  
Non-Vented Fill: 3-1/8"

- Features:
  - Integral Tank Vent with Anti Surge Valve
  - Flame Arrestor (on gas and diesel only)
  - Deck Plate Key Not Required
  - Color Coded Metallic Inserts for Gas, Diesel, Water and Waste

- Fig. 0580: Angled Neck, Vented Gas, Diesel, or Water Fill
- Fig. 0581: Straight Neck, Vented Gas, Diesel, or Water Fill
- Fig. 0551: Straight Neck, Non-Vented Gas, Diesel, or Water Fill
- Fig. 0568: Straight Neck, Non-Vented Waste Fill



**Fig. 0581 Shown**

#### Vented Style Fills Gas, Diesel, or Water Options



**Fig. 0580 Gas Angled**

**Fig. 0581 Diesel Straight**

**Fig. 0580 Water Angled**

#### Non-Vented Style Fills



**Fig. 0551 Gas, Diesel, or Water Options**

**Fig. 0568 Waste<sup>3</sup>**

Type	Neck	Chrome OEM Bulk Pkg.	Stainless OEM Bulk Pkg.
<b>Vented</b>			
Gas <sup>2</sup>	Angled	0580G00CHR <sup>1</sup>	0580G00STS <sup>1</sup>
Diesel <sup>2</sup>	Angled	0580D00CHR	0580D00STS
Water	Angled	0580W00CHR	0580W00STS
Gas <sup>2</sup>	Straight	0581G00CHR <sup>1</sup>	0581G00STS <sup>1</sup>
Diesel <sup>2</sup>	Straight	0581D00CHR	0581D00STS
Water	Straight	0581W00CHR	0581W00STS
<b>Non-Vented</b>			
Gas <sup>2</sup>	Straight	0551G00CHR <sup>1</sup>	0551G00STS <sup>1</sup>
Diesel <sup>2</sup>	Straight	0551D00CHR	0551D00STS
Water	Straight	0551W00CHR	0551W00STS
Waste <sup>3</sup>	Straight	0568000CHR	0568000STS



**Fig. 0540DPRBLK<sup>2</sup> Mounting Ring**

#### Color Coded Metallic Inserts



<sup>1</sup>NOTE: These Items Meet the Requirements of U.S.C.G. Safety Standards, January 31, 1977, for Gasoline Fuel Systems, 33 CFR 183. Fills shown on this page **DO NOT** meet the requirements for 40 CFR 1060 sub part B Emissions Standards and Related Requirements.

#### Spare Parts Ordering Information

Metallic Insert Kit 0030DP0006  
(Includes 4 inserts:  
Gas, Diesel, Water, & Waste)

<sup>2</sup>Note: Consider using the Mounting Ring for all installations. Retail package includes mounting ring. See Page 122

<sup>3</sup>NOTE: Fig. 0568 Complies with Adopted Standards on "Fittings" A.B.Y.C. Recommended Practices Standards Covering Sewage Holding and/or Treatment Devices for Marine Waste Systems.



## Non-EPA Vented and Non-Vented Deck Fills for 1-1/2" Hose with Resin Insert

### Gas, Diesel, Water and Waste Deck Fills

Patent Nos. 5,275,213 & 5,327,946

- Material: Scalloped Bronze or Stainless Steel Cap, Resin Insert, Polymer Body and Tether
- Finish: Chrome Plated or Polished Cap with Black Body and Tether
- Fill Hose Size: 1-1/2"
- Vent Hose Size: 5/8"
- Ground Wire: Not Required
- Mounting Hole Dia: 2-1/8"
- O.D. Flange: 3-3/8"
- Screw Size: #8
- Neck Length: Vented Fills: 2-7/16"  
Non-Vented Fill: 3-1/8"
- Features:
- Integral Tank Vent with Anti Surge Valve
  - Flame Arrestor (on gas and diesel only)
  - Deck Plate Key Not Required
  - Color Coded Resin Inserts for Gas, Diesel, Water and Waste

Fig. 0582: Angled Neck, Vented Gas, Diesel, or Water Fill

Fig. 0583: Straight Neck, Vented Gas, Diesel, or Water Fill

Fig. 0552: Straight Neck, Non-Vented Gas, Diesel, or Water Fill

Fig. 0569: Straight Neck, Non-Vented Waste Fill

**Fig. 0582 Gas Shown**



Type	Neck	Chrome OEM Bulk Pkg.	Stainless OEM Bulk Pkg.	Retail Pkg.
<b>Vented</b>				
Gas <sup>2</sup>	Angled	0582G00CHR <sup>1</sup>	0582G00STS <sup>1</sup>	0582DP0CHR <sup>1</sup>
Diesel <sup>2</sup>	Angled	0582D00CHR	0582D00STS	(Angled Fill, Chrome Cap with 3 Inserts)
Water	Angled	0582W00CHR	0582W00STS	
Gas <sup>2</sup>	Straight	0583G00CHR <sup>1</sup>	0583G00STS <sup>1</sup>	0583DP0CHR <sup>1</sup>
Diesel <sup>2</sup>	Straight	0583D00CHR	0583D00STS	(Straight Fill, Chrome Cap with 3 Inserts)
Water	Straight	0583W00CHR	0583W00STS	
<b>Non-Vented</b>				
Gas <sup>2</sup>	Straight	0552G00CHR <sup>1</sup>	0552G00STS <sup>1</sup>	0552DP0CHR <sup>1</sup>
Diesel <sup>2</sup>	Straight	0552D00CHR	0552D00STS	(Non-Vented Fill, Chrome Cap with 4 Inserts)
Water	Straight	0552W00CHR	0552W00STS	
Waste <sup>3</sup>	Straight	0569000CHR	0569000STS	

#### Color Coded Resin Inserts



**Fig. 0540DPRBLK<sup>2</sup> Mounting Ring**

#### Vented Style Fills



**Fig. 0583 Gas, Diesel, or Water Options**

#### Non-Vented Style Fills



**Fig. 0552 Gas, Diesel, or Water Options**

**Fig. 0569 Waste<sup>3</sup>**

Note: Retail Pkg for vented fills includes fill, cap and 3 inserts (Gas, Diesel, & Water). Use Gas insert on fill only with Non-EPA Compliant fuel systems.

Note: Retail Pkg for non-vented fills includes fill, cap and 4 inserts (Gas, Diesel, Water, & Waste). Use Gas insert on fill only with Non-EPA Compliant fuel systems.

<sup>1</sup>NOTE: These Items Meet the Requirements of U.S.C.G. Safety Standards, January 31, 1977, for Gasoline Fuel Systems, 33 CFR 183. Fills shown on this page **DO NOT** meet the requirements for 40 CFR 1060 sub part B Emissions Standards and Related Requirements.

#### Spare Parts Ordering Information

Cap for Vented Fills: Cap, O-Ring & Retainer: 0582DPC99A (Includes 3 Resin inserts: Gas, Diesel & Water)

Cap for Non-Vented Fills: 0552DPC99A (incl. 4 inserts)

Resin Insert Kit: 0030DP0004 (includes 4 inserts: Gas, Diesel, Water, & Waste)

<sup>2</sup>Note: Consider using the Mounting Ring for all installations. Retail package includes mounting ring. See Page 122

<sup>3</sup>NOTE: Fig. 0569 Complies with Adopted Standards on "Fittings" A.B.Y.C. Recommended Practices Standards Covering Sewage Holding and/or Treatment Devices for Marine Waste Systems.



## Non-EPA Vented and Non-Vented Deck Fills for 1-1/2" Hose

### Gas, Diesel, Water and Waste Deck Fills

Patent Nos. 5,275,213 & 5,327,946

Material: Bronze Cap, Polymer Body with Stainless Steel Bead Chain (Except for Waste)  
 Finish: Chrome Plated Cap with Black Body  
 Fill Hose Size: 1-1/2"  
 Vent Hose Size: 5/8"  
 Ground Wire: Not Required  
 Mounting Hole Dia: 2-1/8"  
 O.D. Flange: 3-3/8"  
 Screw Size: #8  
 Neck Length: Vented Fills: 2-7/16"  
 Non-Vented Fill: 3-1/8"

- Features:
- Integral Tank Vent with Anti Surge Valve
  - Flame Arrestor (on gas and diesel only)
  - Deck Plate Key Not Required

Fig. 0590: Angled Neck, Vented Gas, Diesel, or Water Fill  
 Fig. 0591: Straight Neck, Vented Gas, Diesel, or Water Fill  
 Fig. 0564: Straight Neck, Non-Vented Gas, Diesel, or Water Fill  
 Fig. 0563: Straight Neck, Non-Vented Waste Fill



**Fig. 0590 Gas Shown**

Type	Neck	Cap Material	Retail Pkg.	OEM Bulk Pkg.
<b>Vented</b>				
Gas <sup>2</sup>	Angled	Chrome	0590DPGCHR <sup>1</sup>	0590G00CHR <sup>1</sup>
Diesel <sup>2</sup>	Angled	Chrome	0590DPDCHR	0590D00CHR
Water	Angled	Chrome	0590DPWCHR	0590W00CHR
Gas <sup>2</sup>	Straight	Chrome	0591DPGCHR <sup>1</sup>	0591G00CHR <sup>1</sup>
Diesel <sup>2</sup>	Straight	Chrome	0591DPDCHR	0591D00CHR
Water	Straight	Chrome	0591DPWCHR	0591W00CHR
<b>Non-Vented</b>				
Gas <sup>2</sup>	Straight	Chrome	0564DPGCHR <sup>1</sup>	0564G00CHR <sup>1</sup>
Diesel <sup>2</sup>	Straight	Chrome	0564DPDCHR	0564D00CHR
Water	Straight	Chrome	0564DPWCHR	0564W00CHR
Waste <sup>3</sup>	Straight	Chrome	0563DP0CHR	0563000CHR

#### Vented Style Fills



**Fig. 0590**  
Gas, Diesel or Water Options

**Fig. 0591**



**Fig. 0540DPRBLK<sup>2</sup>**  
Mounting Ring

#### Non-Vented Style Fills



**Fig. 0564**  
Gas, Diesel or Water Options

**Fig. 0563**  
Waste<sup>3</sup>

<sup>1</sup>NOTE: These Items Meet the Requirements of U.S.C.G. Safety Standards, January 31, 1977, for Gasoline Fuel Systems, 33 CFR 183.  
 Fills shown on this page **DO NOT** meet the requirements for 40 CFR 1060 sub part B Emissions Standards and Related Requirements.

#### Spare Parts Ordering Information

Figs. 0590/0591 Gas Cap, O-Ring & Retainer: 0590DPG99A  
 Figs. 0564/0590/0591 Diesel Cap, O-Ring, & Retainer: 0590DPD99A  
 Figs. 0564/0590/0591 Water Cap, O-Ring, & Retainer: 0590DPW99A  
 Fig. 0563 Waste Cap with O-Ring: 0563DP099A  
 O-Ring Only: 054000099B

<sup>2</sup>Note: Consider using the Mounting Ring for all installations. Retail package includes mounting ring. See Page 122

<sup>3</sup>NOTE: Fig. 0563 Complies with Adopted Standards on "Fittings" A.B.Y.C. Recommended Practices Standards Covering Sewage Holding and/or Treatment Devices for Marine Waste Systems.

**PROP 65**  
**WARNING**  
(Contains Lead)



7 Deck Plates, Fills, Tank Vents, and Ventilators

## Non-EPA Vented Flip Top Deck Fills for 1-1/2" Hose

### Flip-Top Gas and Water Deck Fills

Patent No. 5,275,213

Material: All Polymer Body & Cap  
 Finish: Fig. 1318: Black Cap and Body  
 Fig. 1319: Black or White Cap and Body  
 Fill Hose Size: 1-1/2"  
 Vent Hose Size: 5/8"  
 Ground Wire: Not Required  
 Screw Size: #10  
 Neck Length: 2-7/16"

Features:

- Integral Tank Vent with Anti Surge Valve
- Flame Arrestor (on gas only)
- Deck Plate Key Not Required

Fig. 1318: 35° Angled Neck, Vented Gas  
 Fig. 1319: Straight Neck, Vented Gas, or Water Fill

Fig. 1318



Fig. 1319

Type	Neck	Body Color	Retail Pkg.	OEM Bulk Pkg.
Gas	Angled	Black	1318DPGBLK <sup>1</sup>	1318G00BLK <sup>1</sup>
Gas	Straight	Black	1319DPGBLK <sup>1</sup>	1319G00BLK <sup>1</sup>
Gas	Straight	White	1319DPGWHT <sup>1</sup>	1319G00WHT <sup>1</sup>
Water	Straight	Black	1319DPWBLK	1319W00BLK
Water	Straight	White	1319DPWWHT	1319W00WHT

### Replacement Vented Flip-Top Cap for Non-EPA Fills with 1-1/2" Hose

Material: Polymer  
 Finish: Black or White  
 Installation: Requires 5-1/4" Dia. Mounting Surface  
 Screw Size: #8  
 Features:

- Easily Mounts Directly on Gunnel without Removing Fill Body
- Includes Metallic Inserts for Gas, Diesel, or Water Fills
- Integral Tank Vent with Flame Arrestor and Anti Surge Valve
- No Deck Plate Key or Ground Wire Required

**NEW  
PRODUCT**



Fig. 0795

**NOTICE:**  
**Fig. 0795 NOT for replacement of any ratcheting (and/or EPA style) fuel caps**

**Use Fig. 0795 ONLY with PERKO® Vented Fills**  
 Fig. Nos.: 0540, 0541, 0542, 0543, 0580, 0581, 0582, 0583, 0590 & 0591

Color	Retail Pkg.
Black	0795DP0BLK <sup>1</sup>
White	0795DP0WHT <sup>1</sup>

**COLOR CODED METALLIC INSERTS**



White

Black

<sup>1</sup>NOTE: These Items Meet the Requirements of U.S.C.G. Safety Standards, January 31, 1977, for Gasoline Fuel Systems, 33 CFR 183. Fills shown on this page **DO NOT** meet the requirements for 40 CFR 1060 sub part B Emissions Standards and Related Requirements.

## Non-EPA Vented and Non-Vented Deck Fills for Hose

### Gas and Water Deck Fills for 1-1/2" Hose

Patent Nos. 5,275,213 & 5,327,946

- Material: All Polymer Body, Cap, & Retainer  
 Finish: Black or White Cap with Black Body  
 Hose Size: 1-1/2"  
 Vent Hose Size: 5/8"  
 Ground Wire: Not Required  
 Mounting Hole Dia: 2-1/8"  
 O.D. Flange: 3-3/8"  
 Screw Size: #8  
 Neck Length: 2-7/16"  
 Features:
- Integral Tank Vent with Anti Surge Valve
  - Flame Arrestor (on gas and diesel only)
  - Deck Plate Key Included

Fig. 0542: Angled Neck, Vented Gas, or Water Fill

Fig. 0543: Straight Neck, Vented Gas, or Water Fill



Fig. 1247



Type	Neck	Cap Color	Retail Pkg.	OEM Bulk Pkg.
Gas <sup>2</sup>	Angled	Black	0542DPGBLK <sup>1</sup>	0542G00BLK <sup>1</sup>
Gas <sup>2</sup>	Angled	White	0542DPGWHT <sup>1</sup>	0542G00WHT <sup>1</sup>
Gas <sup>2</sup>	Straight	Black	0543DPGBLK <sup>1</sup>	0543G00BLK <sup>1</sup>
Gas <sup>2</sup>	Straight	White	0543DPGWHT <sup>1</sup>	0543G00WHT <sup>1</sup>
Water	Angled	Black	0542DPWBLK	0542W00BLK
Water	Straight	Black	0543DPWBLK	0543W00BLK



Fig. 0540DPRBLK<sup>2</sup>  
Mounting Ring



Fig. 0543  
Gas



Fig. 0542  
Water



Fig. 0543  
Water

### Gas and Water Deck Fills for 2" Hose

Patent No. 5,275,213

- Material: Bronze  
 Finish: Chrome Plated  
 Fill Hose Size: 2"  
 Vent Hose Size: 5/8" (vented fills only)  
 Screw Size: #8  
 Ground Wire: Required  
 O.D. Flange: Fig 0576: 3-3/8"  
 Mounting Hole Dia.: Fig 0576: 2-1/4"  
 Neck Length: Fig. 0576 & 0577: 3-5/8"  
 Fig. 0579: 4-3/4"  
 Features:
- Integral Tank Vent with Flame Arrestor (on Vented Fills Only)
  - Deck Plate Key, O-Ring, and Integral Retainer on Cap Included

Fig. 0576: Straight Neck, Non-Vented Gas, or Diesel Fill

Fig. 0577: Straight Neck, Vented Gas, or Diesel Fill

Fig. 0579: Angled Neck, Vented Gas, or Diesel Fill



Fig. 1247

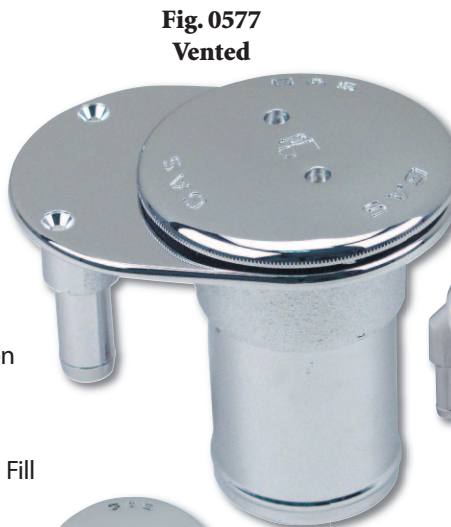

Fig. 0577  
Vented



Alternate  
Style Cap  
Available.  
Contact Factory.



Fig. 0576  
Non-Vented



Fig. 0579  
Vented



Marked	Neck	Vented	Standard Pkg.
Gas	Straight	Yes	0577G00CHR <sup>1</sup>
Diesel	Straight	Yes	0577D00CHR
Gas	Angled	Yes	0579G00CHR <sup>1</sup>
Diesel	Angled	Yes	0579D00CHR
Gas	Straight	No	0576G00CHR <sup>1</sup>
Diesel	Straight	No	0576D00CHR

<sup>1</sup>NOTE: These Items Meet the Requirements of U.S.C.G. Safety Standards, January 31, 1977, for Gasoline Fuel Systems, 33 CFR 183.

Fills shown on this page **DO NOT** meet the requirements for 40 CFR 1060 sub part B Emissions Standards and Related Requirements.

#### Spare Parts Ordering Information

##### Figs. 0542 & 0543

Black Gas Cap, O-Ring, & Retainer: 0542DPG99B,  
 White Gas Cap, O-Ring, & Retainer: 0542DPG99W,  
 Black Water Cap, O-Ring, & Retainer: 0542DPW99B,  
 O-Ring Only: 054000099B

##### Figs. 0576, 0577 & 0579

Gas Cap & O-Ring: 0576DPG99A  
 Diesel Cap & O-Ring: 0576DPD99A  
 Retaining Ring: 0537DP2  
 Deck Plate Key: 1247DP0BLK

<sup>2</sup>Note: Consider using the Mounting Ring for all installations. Retail package includes mounting ring. See Page 122



## Non-EPA, Non-Vented Deck Fills for 1-1/2" Hose

### Non-Vented Gas, Diesel, Water and Waste Deck Fills for 1-1/2" Hose

Material: Bronze  
 Finish: Chrome Plated  
 Fill Hose Size: 1-1/2"  
 Screw Size: #8  
 Ground Wire: Required for Fig. 0520 Gas Fills  
 O.D. Flange: 3-1/8"  
 Mounting Hole Dia.: 2-1/8"  
 Neck Length: 3-1/2"  
 Features:

- Deck Plate Key and O-Ring Included
- Cap Has a Slot Between the Holes

Fig. 0520: Non-Vented Gas, Diesel, or Water Fills with Retainer on Cap

Fig. 0507: Non-Vented Waste Fill



**Fig. 0520**  
Gas, Diesel & Water



**Fig. 0507** Waste



**Fig. 1248**

**PROP 65**  
**WARNING**  
(Contains Lead)

Type	Retail Pkg.	OEM Bulk Pkg.
Gas	0520DPGCHR <sup>1</sup>	0520G00CHR <sup>1</sup>
Diesel	0520DPDCHR	0520D00CHR
Water	0520DPWCHR	0520W00CHR
Waste <sup>2</sup>	0507DP0CHR	0507000CHR

### Non-Vented Gas, Diesel, Water and Waste Deck Fills for 1-1/2" Hose

Material: Zinc Alloy Body, Polymer Cap  
 Finish: Chrome Plated  
 Fill Hose Size: 1-1/2"  
 Screw Size: #8  
 Ground Wire: Required for Fig. 1270 Gas Fills  
 O.D. Flange: 3-1/8"  
 Mounting Hole Dia.: 2-1/8"  
 Neck Length: 3-1/2"  
 Features:

- Deck Plate Key and O-Ring Included
- Cap Has a Slot Between the Holes

Fig. 1270: Non-Vented Gas, Diesel, or Water Fills with Retainer on Cap

Fig. 1269: Non-Vented Waste Fill



**Fig. 1269** Waste



**Fig. 1270**  
Gas, Diesel & Water



**Fig. 1248**

Type	Retail Pkg.	OEM Bulk Pkg.
Gas	1270DPGCHR <sup>1</sup>	1270G00CHR <sup>1</sup>
Diesel	1270DPDCHR	1270D00CHR
Water	1270DPWCHR	1270W00CHR
Waste <sup>2</sup>	1269DP0CHR	1269000CHR

<sup>1</sup>NOTE: These Items Meet the Requirements of U.S.C.G. Safety Standards, January 31, 1977, for Gasoline Fuel Systems, 33 CFR 183. Fills shown on this page **DO NOT** meet the requirements for 40 CFR 1060 sub part B Emissions Standards and Related Requirements.

<sup>2</sup>NOTE: Figs. 0507 & 1269 Comply with Adopted Standards on "Fittings" A.B.Y.C. Recommended Practices Standards Covering Sewage Holding and/or Treatment Devices for Marine Waste Systems.

#### Spare Parts Ordering Information

##### Figs. 0520 & 0507

Fig. 0520 Cap with O-Ring and Retainer: 0520DP099A.  
 Fig. 0507 Waste Cap with O-Ring: 0507DP099A.  
 O-Rings Only (2 per bag): 0520DP099B Deck Plate Key: 12487-8DP.

##### Figs. 1269 & 1270

Fig. 1270 Gas Cap with O-Ring and Retainer: 1270DPG99A  
 Fig. 1270 Diesel Cap with O-Ring and Retainer: 1270DPD99A  
 Fig. 1270 Water Cap with O-Ring and Retainer: 1270DPW99A  
 Fig. 1269 Waste Cap with O-Ring: 1269DP099A  
 O-Rings Only (2 per bag): 0513DP8 Deck Plate Key: 12487-8DP

## Non-EPA, Non-Vented Deck Fills for 1-1/2" Hose

### Non-Vented Gas and Diesel Fills with Locking Cap for 1-1/2" Hose

Patent No. 3,828,714

Material:	Bronze Flange and Polymer Body and Cap
Finish:	Chrome Plated Flange and Black Body
Fill Hose Size:	1-1/2"
Screw Size:	#8
Ground Wire:	Required (Grounding Screw Included)
O.D. Flange:	3-3/8"
Mounting Hole Dia.:	2-1/8"
Neck Length:	3-1/8"
Features:	<ul style="list-style-type: none"> <li>• Cap Retainer and Gasket Included</li> <li>• Locking Cap Has a Cover for the Key Hole</li> <li>• Locking Cap with Strap</li> </ul>



Fig. 0599

Type	Retail Pkg.	OEM Bulk Pkg.
Gas	0599DPGCHR <sup>1</sup>	0599G00CHR <sup>1</sup>
Diesel	0599DPDCHR	0599D00CHR

**Spare Parts Ordering Information**

Cap with O-Ring and 2 Keys: 1324DP1BLK.



### Non-Vented Gas Fills for 1-1/2" Hose

Patent No. 3,828,714

Material:	Zinc Alloy Body with Polymer Flange, Cap, and Strap
Finish:	Black Flange
Fill Hose Size:	1-1/2"
Screw Size:	#6
Ground Wire:	Required (Grounding Screw Included)
O.D. Flange:	3-1/8"
Mounting Hole Dia.:	2-1/8"
Neck Length:	1-7/8"
Features:	Cap Retainer and Gasket Included

Fig. 1313: Non-Locking Fill

Fig. 1399: Locking Fill Cap with Cover for the Key Hole



Fig. 1399



Fig. 1313

Type	Retail Pkg.	OEM Bulk Pkg.
Gas	1313DP0CHR <sup>1</sup>	1313000CHR <sup>1</sup>
Gas w/Lock	1399DP0CHR <sup>1</sup>	1399000CHR <sup>1</sup>

**Spare Parts Ordering Information**

Non-Locking Cap: 0126DP0BLK

Locking Cap with 2 Keys: 1324DP0BLK



### Non-Vented Gas Fill for 1-1/2" Hose - Patent No. 3,828,714

Material:	Fiber Reinforced, U.V. Stabilized Polymer Body and Cap
Finish:	Black
Fill Hose Size:	1-1/2"
Screw Size:	#8
Ground Wire:	Not Required
O.D. Flange:	3-1/16"
Mounting Hole Dia.:	1-3/4"
Neck Length:	2-7/16"
Features:	<ul style="list-style-type: none"> <li>• O-Ring and Cap Retainer Included</li> <li>• Easy-Grip Cap, No Deck Plate Key Required</li> </ul>



Fig. 1613



Type	Retail Pkg.	OEM Bulk Pkg.
Gas	1613DP0BLK <sup>1</sup>	1613000BLK <sup>1</sup>

**Spare Parts Ordering Information**

Cap with O-Ring and Retainer: 161300099A

O-Rings (2 per bag): 1313DP099A

<sup>1</sup>NOTE: These Items Meet the Requirements of U.S.C.G. Safety Standards, January 31, 1977, for Gasoline Fuel Systems, 33 CFR 183. Fills shown on this page **DO NOT** meet the requirements for 40 CFR 1060 sub part B Emissions Standards and Related Requirements.

## Non-EPA, Non-Vented Deck Fills for Pipe

### Non-Vented Deck Plates For Pipe

Patent No. 3,828,714

- Material: Cast Bronze  
 Finish: Plain or Chrome Plated  
 For Pipe Sizes: 1" to 3" NPS  
 Screw Size: #8 for 1", 1-1/4", 1-1/2" and 2"  
 #10 for 2-1/2" and 3"  
 Ground Wire: Required (for Gas)  
 Features:
- Deck Plate Key and O-Ring Included
  - Pipe Sizes 1", 1-1/4" and 1-1/2" Inch Caps Have a Slot Between the Holes
  - Pipe Sizes 2", 2-1/2" and 3" Inch Have 4 Mounting Holes



Fig. 1248



Fig. 0528 Gas

For Unmarked Fills					
Pipe Size	O.D. Flange	Mounting Hole Dia.	Plain Standard Pkg.	Chr. Plated Retail Pkg.	Chr. Plated OEM Bulk Pkg.
1"	2-7/8"	1-1/2"	0528006PLB	0528006CHR	-----
1-1/4"	3-5/16"	2-1/8"	0528007PLB	0528007CHR	-----
1-1/2"	3-5/8"	2-3/8"	0528008PLB	0528DP8CHR	0528008CHR
2"	4-1/4"	3"	0528009PLB	0528009CHR	-----
2-1/2"	4-5/8"	3-5/8"	0528010PLB	0528010CHR	-----
3"	5-3/8"	4"	0528011PLB	0528011CHR	-----

For Gas Fills <sup>1</sup>					
Pipe Size	O.D. Flange	Mounting Hole Dia.	Plain Standard Pkg.	Chr. Plated Retail Pkg.	Chr. Plated OEM Bulk Pkg.
1-1/2"	3-5/8"	2-3/8"	0528G08PLB	0528DPGCHR	0528G08CHR
2"	4-1/4"	3"	-----	0528G09CHR	0528G09CHR

For Diesel Fills					
Pipe Size	O.D. Flange	Mounting Hole Dia.	Plain Standard Pkg.	Chr. Plated Retail Pkg.	Chr. Plated OEM Bulk Pkg.
1-1/2"	3-5/8"	2-3/8"	0528D08PLB	0528DPDCHR	0528D08CHR
2"	4-1/4"	3"	0528D09PLB	0528D09CHR	-----

For Water Fills					
Pipe Size	O.D. Flange	Mounting Hole Dia.	Plain Standard Pkg.	Chr. Plated Retail Pkg.	Chr. Plated OEM Bulk Pkg.
1-1/2"	3-5/8"	2-3/8"	0528W08PLB	0528DPWCHR	0528W08CHR

For Waste Fills <sup>2</sup>					
Pipe Size	O.D. Flange	Mounting Hole Dia.	Plain Standard Pkg.	Chr. Plated Retail Pkg.	Chr. Plated OEM Bulk Pkg.
1-1/2"	3-5/8"	2-3/8"	-----	0524DPOCHR	0524000CHR



Fig. 0528 Diesel



Fig. 0528 Water



Fig. 0528 Unmarked Plain



Fig. 0528 Unmarked Chrome



Fig. 0524 Waste<sup>2</sup>

<sup>1</sup>NOTE: These Items Meet the Requirements of U.S.C.G. Safety Standards, January 31, 1977, for Gasoline Fuel Systems, 33 CFR 183. Fills shown on this page **DO NOT** meet the requirements for 40 CFR 1060 sub part B Emissions Standards and Related Requirements.

<sup>2</sup>NOTE: Fig. 0524 Complies with Adopted Standards on "Fittings" A.B.Y.C. Recommended Practices Standards Covering Sewage Holding and/or Treatment Devices for Marine Waste Systems.

#### Spare Parts Ordering Information

Pipe Size	Plain Bronze Cap with O-Ring	Chr. Plated Bronze Cap with O-Ring	Chr. Plated Bronze Waste Cap w/O-Ring	O-Rings Only (2/bag, 5 bags/Pkg)	Spare Key
1"	0528P0699A	0528C0699A	-----	0513006	1248006DP
1-1/4"	0528P0799A	0528C0799A	-----	0513007	12487-8DP
1-1/2"	0528P0899A	0528DP899A	0524DP099A	0513DP8	12487-8DP
2"	0528P0999A	0528C0999A	-----	0513009	1248009DP
2-1/2"	0528P1099A	0528C1099A	-----	0513010	1248010ZNC
3"	0528P1199A	0528C1199A	-----	0513011	052801199C



## Fuel System Locking Insert, Caps, Mounting Ring and Retaining Cable

### Fuel System Locking Insert for 1-1/2" Vented Fills

- Material: Polymer Body with Zinc Alloy Lock Cylinder
- Features:
- Dual Purpose Key Opens Fill Cap & Locking Insert
  - Fits Most PERKO® Vented Fills
  - Available in Dealer Package or 12 Piece Countertop Display

**Note: Not for use with EPA Compliant gas fills with Vacuum Pressure Relief valves (VPR) Perko Fig. Nos. 0660, 0661, 0662, 0663, 0780, 0781, 0782, 0783, 0790 & 0791**

<b>Retail Pkg.</b> 0525DP0BLK	<b>P.O.P. Display</b> 0525DP0DIS
----------------------------------	-------------------------------------



Counter Display

### Fuel System Locking Cap for 1-1/2" Non-Vented Fills

- Material: Polymer Body and Gasket with Zinc Alloy Lock Cylinder
- Features:
- Built in Lock Cylinder with Cover for Key Hole
  - Size #0 Fits PERKO Fills 1313 & 1399
  - Size #1 Fits PERKO Fills 0520, 0527, 0528, 0557, 0599 and 1270

<b>Retail Pkg.</b> 1324DP0BLK 1324DP1BLK	<b>Cap Outside Thread Diameter</b> 1-15/32" 1-7/8"
--	--



Fig. 0520 Fill Shown with Locking Cap

Fig. 1324

### Mounting Ring for Vented Fills

#### Installation Note: on the use of Vented Fuel Fills

PERKO® Fig. Nos. 0540, 0541, 0542, 0543, 0580, 0581, 0582, 0583, 0590, 0591, 0660, 0611, 0662, 0663, 0780, 0781, 0782, 0783, 0790 & 0791

The use of these heightening rings is required in any application where water might be splashed around a vented fill. The ring raises the opening between the fuel cap and fill an additional 3/8" above the deck surface, thereby reducing the likelihood that splashed water will enter the fuel system through the breathing vent. The split version of the ring is designed for aftermarket use on existing installations. In most cases, it allows the ring to be added without disconnecting fuel and vent hoses from the fill. For new OEM installations, rings are supplied without the split since they can be installed before hoses are connected to the fill.

NOTE: The ring will not prevent water from entering the system if the cap becomes submerged or substantially flooded. If this situation exists, the fill/vent must be moved to a dry location or replaced with a sealed cap and a separate vent located elsewhere.

- Material: Polymer Ring
- Finish: Black

<b>Retail Pkg.</b> 0540DPRBLK	<b>OEM Bulk Pkg.</b> 0540RNGBLK
----------------------------------	------------------------------------

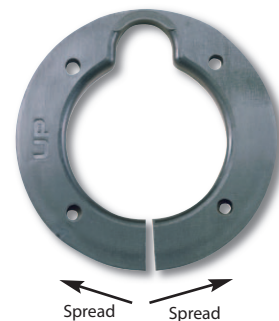

Fig. 0540 Ring

### Retaining Cable for Deck Plates

- Material: Stainless Steel Cable, Ring, Fittings and Self Tapping Screw
- Cable Length: 7"

<b>Fill Hose Size</b>	<b>Ring Dia.</b>	<b>Retail Pkg.</b>
1-1/2"	1-3/8"	0537DP
2"	2"	0537DP2



Fig. 0537

## Deck Plate Keys

### Deck Plate Keys

- Material: Polymer  
 Cntr to Cntr of Lugs: 1-1/8"  
 Length Spade: 1"  
 Fits: PERKO 1-1/4" and 1-1/2" Deck Plates and Many Other "Slot" Type Opening Deck Plates
- Features: Fig. 1241:
  - Universal Deck Plate Key
  - 2 Holes for Key Chain
 Fig. 1247:
  - Compact Size
  - One Hole for Key Chain



**Fig. 1241**

For use with these style caps



Length Overall	Retail Pkg.	OEM Bulk Pkg.
4"	1241DP0BLK	1241000BLK
1-3/4"	1247DP0BLK	1247000BLK

For use with these style caps



**Fig. 1247**

### Deck Plate Keys

- Material: Polymer or Zinc Alloy  
 Finish: Black or Plain Zinc  
 Length Spade: 1"  
 Fits: 1" Thru 1-1/2" Deck Plates and Many Other "Slot" Type Opening Deck Plates
- Features: One Hole for Key Chain



**Fig. 1248 - Polymer**



**Zinc-Alloy**

For Deck Plate Size	Center to Center of Lugs	Length Overall	Material	Retail Pkg.	Standard. Pkg.
1"	5/8"	3-3/8"	Polymer	1248006DP	-----
1-1/4" & 1-1/2"	1-1/8"	3-3/8"	Polymer	12487-8DP	12487-8BLK
2"	1-11/16"	4-3/8"	Zinc	1248009DP	-----
2-1/2"	2"	4-3/8"	Zinc	-----	1248010ZNC

For use with these style caps



### Adjustable Deck Plate Key

- Material: Zinc Alloy  
 Finish: Chrome Plated  
 Fits: Deck Plates up to 8" Diameter
- Features:
  - One Hole for Key Chain
  - Hardened Steel Pins

Length Overall	Retail Pkg.
8-1/2"	0826DP0CHR

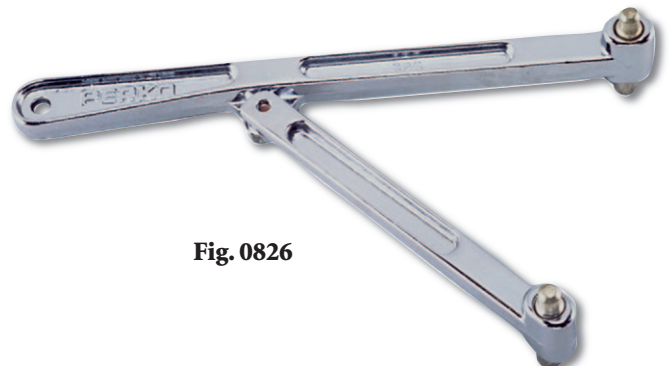

**Fig. 0826**

## Replacement Pressure Relief Caps for EPA/CARB Fuel Systems

### Retail Packaged EPA & CARB Compliant Sealed Caps with Vacuum Pressure Relief valve (VPR)

All caps listed are interchangeable with PERKO® brand EPA/CARB Compliant Fills ONLY: Figs. 0640, 0641, 0642, 0643, 0660, 0661, 0662, 0663, 0680, 0681, 0682, 0683, 0690, 0691, 0780, 0781, 0782, 0783, 0790 & 0791

#### Material & Finish:

- A: Chrome Plated Bronze
- B & C: Black or White Polymer
- D: Chrome Plated Bronze
- E, F, & G: Stainless Steel Scalloped Cap with either
  - Red Metallic Insert
  - Red Metallic "No E-15" Insert Decal
  - Gray Metallic Gas Insert
- H: Stainless Steel Scalloped Cap with Resin Gas Decal

Features: All VPR Caps fit 1-1/2" Fills  
All Caps Include O-Ring and Retainer

### Sealed Cap with VPR Valve

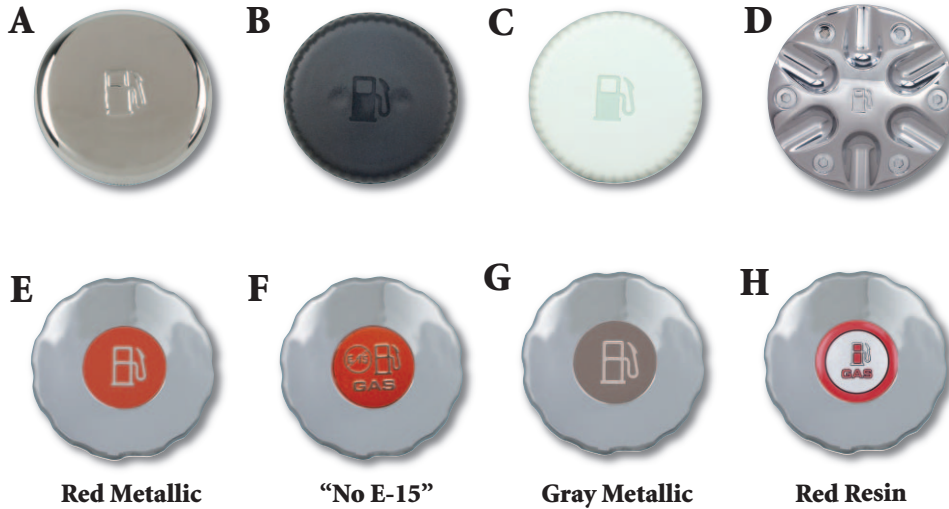

Red Metallic

"No E-15"

Gray Metallic

Red Resin

Cap Style	Cap Type	Insert Type	Retail Pkg
A	Chrome	None	0660DPG99A
B	Black Polymer	None	0662DPG99B
C	White Polymer	None	0662DPG99W
D	Chrome	None	0790DPG99A
E	Stainless	Red Metallic	0780DPG98S
F	Stainless	"No E-15"	0780DPG98N
G	Stainless	Gray Metallic	0780DPG98G
H	Stainless	Red Resin	0782DPG98S



These caps meet the CARB and EPA requirements of U.S.C.G. Safety Standards (July 31, 2011) for 40 CFR Parts 9, 60, 80 et al. Control of Diurnal Emissions From Nonroad Spark-Ignition Engines and Equipment.

## Replacement Caps for Diesel, Water, Waste and Non-EPA/CARB Gas Fills

**\*Warning: These caps are NOT for use with EPA Compliant sealed fuel systems.**

**\*\*Note: Replacement waste caps are non-vented and do not include a retainer**

**Material & Finish:**

**For: Figs. 0540, 0541, 0542, 0543, 0580, 0581, 0582, 0583, 0590 & 0591**

- I: Chrome Plated Bronze - Vented
- J: Chrome Plated Bronze - Vented
- K: Black or White Polymer - Vented
- L: Chrome Plated Bronze Scalloped-Vented w/Resin Insert

**For: Figs. 0576 & 0579**

- M: Chrome Plated Bronze - Vented for 2" Fill

**For: Figs. 0552 & 0569**

- N: Chrome Plated Bronze, Scalloped - Non-Vented w/Resin Insert

**For: Figs. 0520, 0524 & 0507**

- O: Chrome Plated Bronze - Non-Vented

**For: Fig. 1270**

- P: Black Polymer - Non-Vented

Features: All Caps fit 1-1/2" Fills (Except Fig. 0576 Style)

All Caps Include O-Ring and Retainer (Except Waste)

**Vented Cap  
Shown**



**Retail Pkg.**

**I**



**Fig. 0540 Style - Vented:**

- Gas: 0540DPG99A\*
- Diesel: 0540DPD99A
- Water: 0540DPW99A
- Waste: 0556DP099A\*\*

**J**



**Fig. 0590 Style - Vented:**

- Gas: 0590DPG99A\*
- Diesel: 0590DPD99A
- Water: 0590DPW99A
- Waste: 0563DP099A\*\*

**K**



**Fig. 0542 Style - Vented:**

- Gas: Blk: 0542DPG99B\*  
Wh: 0542DPG99W\*
- Water: Blk: 0542DPW99B  
Wh: 0542DPW99W

**L**



**Fig. 0582 Style- Vented: 0582DPC99A\***  
(Includes 3 inserts Gas\*, Diesel, & Water)



**M**



**Fig. 0576 Style - Vented for 2" Fills:**

- Gas: 0576DPG99A\*
- Diesel: 0576DPD99A



**Retail Pkg.**

**N**



**Fig. 0552 Style- Non Vented:**

0552DPC99A\* (Includes 4 inserts  
Gas\*, Diesel, Water, & Waste)



**O**



**Fig. 0520, 0524 & 0507 Style - Non-Vented:**

- Fig. 0507: 0507DP099A\*\*
- Fig. 0520: 0520DP099A
- Fig. 0524: 0524DP099A\*\*
- Fig. 0528: See Page 121

**P**



**Fig. 1270 Style - Non-Vented:**

- Gas: 1270DPG99A
- Diesel: 1270DPD99A
- Water: 1270DPW99A

**Metallic Insert Kit - 0030DP0006**

Replacement Metallic decal kit. Contains one each Gas, Diesel, Water, & Waste decals. For Use with: Figs. 0580, 0581, 0551 & 0568



**Resin Insert Kit - 0030DP0004**

Replacement Resin decal kit. Contains one each Gas, Diesel, Water, & Waste decals. For Use with: Figs. 0552, 0569, 0582 & 0583



## Cowl and Clam Shell Ventilators

### Cowl Ventilator

Material: Zinc Alloy and Polymer Base  
 Finish: Chrome Plated with Black Base  
 Dimensions: Length: 5-3/4", Width: 4-3/8", Height: 2-5/8"  
 Cowl Opening: 8 Square Inches  
 Installs: 3" Duct Threads into Neck, Hose Clamps Not Required  
 Screw Size: #8

Retail Pkg.	OEM Bulk Pkg.
1312DP0CHR	1312000CHR



Fig. 1312

### Cowl Ventilator

Material: Zinc Alloy  
 Finish: Chrome Plated with Black PERKO-KOTE Base  
 Dimensions: Length: 5-1/8", Width: 4", Height: 3-7/8"  
 Cowl Opening: 7-1/3 Square Inches  
 Installs: 3" Duct Threads into Neck, Hose Clamps Not Required  
 Screw Size: #10

Retail Pkg.	OEM Bulk Pkg.
0870DP0CHR	0870000CHR



Fig. 0870

### Cowl Ventilator

Material: Brass with Cast Bronze Deck Plate  
 Finish: Chrome Plated or Polished with Painted White Ventilator inside  
 Dimensions: I.D. Deck Plate: 4", O.D. Deck Plate: 7-1/16"  
 Cowl Opening: Dia. 8", Width Opening: 8", Height Opening: 11"  
 Screw Size: #10  
 Features: Internal Thumb Screw Allows Cowl to be Locked in any Position

Std. Pkg. Polished	Std. Pkg. Chrome Plated
0510004POL	0510004CHR



Fig. 0510

Spare Deck Plates, Covers and Keys; Refer to Fig. No. 0526, Pg 129.

### Clam Shell Ventilator

Material: Brass or Stainless Steel  
 Finish: Chrome Plated or Polished

Finish	Retail Pkg.	OEM Bulk Pkg.	Screw Size	Base Dimensions	Opening Height	Opening Width
Chrome	0315DP1CHR	0315001CHR	4	1-5/8" x 1-1/2"	7/16"	7/8"
Chrome	0315DP2CHR	0315002CHR	6	2" x 2"	9/16"	1-1/8"
Polished SS	0315DP1STS	0315001STS	4	1-5/8" x 1-1/2"	7/16"	7/8"
Polished SS	0315DP2STS	0315002STS	6	2" x 2"	9/16"	1-1/8"



Fig. 0315

### Clam Shell Ventilator

Material: Brass  
 Finish: Chrome Plated  
 Dimensions: Base: 4" x 3-3/4"  
 Cowl Opening: Width Opening: 2-1/2", Height Opening: 1-5/8"  
 Screw Size: #6

Retail Pkg.	OEM Bulk Pkg.
0339DP0CHR	0339000CHR



Fig. 0339



7 Deck Plates, Fills, Tank Vents, and Ventilators



## Compartment Ventilators

### Ventilator

Material: Brass  
 Finish: Chrome Plated Frame and Screen  
 Dimensions: Length: 7-1/4", Width: 1-1/2"  
 Screw Size: #8



Fig. 0707



Retail Pkg.	OEM Bulk Pkg.
0707DP0CHR	0707000CHR

### Ventilator

Material: Brass or Stainless Steel  
 Finish: Chrome Plated or Polished  
 Dimensions: O.D. Size 1: 2-1/2"  
 O.D. Size 2: 3-1/4"  
 Screw Size: #6 R.H.

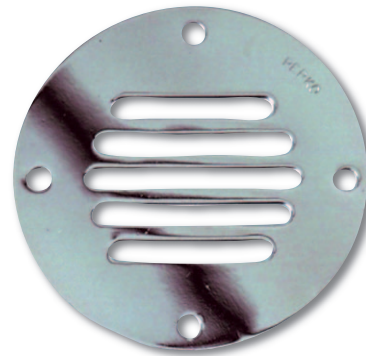

Fig. 0330



Finish	Retail Pkg.	OEM Bulk Pkg.
Chrome	0330DP1CHR	0330001CHR
Chrome	0330DP2CHR	0330002CHR
Polished SS	0330DP1STS	0330001STS
Polished SS	0330DP2STS	0330002STS

### Transom or Locker Ventilator

Material: Zinc Alloy with Anodized Aluminum Expanded Mesh Screen  
 Finish: Chrome Plated  
 Dimensions: Width: 6", Height: 2"  
 Screw Size: #8

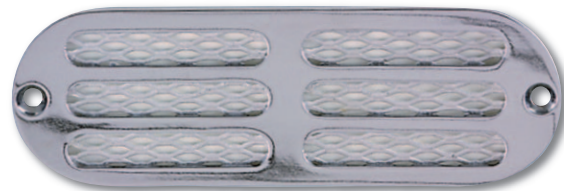

Fig. 1271

Retail Pkg.	OEM Bulk Pkg.
1271DP0CHR	1271000CHR

### Transom or Locker Ventilator

Material: Zinc Alloy with Anodized Aluminum Grill Type Screen  
 Finish: Chrome Plated  
 Dimensions: Width: 8-3/4", Height: 2-1/4"  
 Screw Size: #8

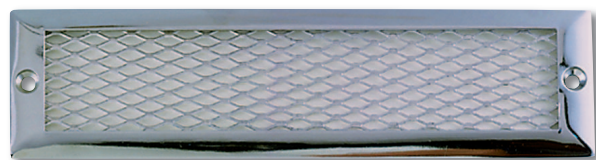

Fig. 1238

Retail Pkg.	OEM Bulk Pkg.
1238DP0CHR	1238000CHR

## Louver Ventilators

### Louver Ventilator

Material: Brass or Stainless Steel  
 Finish: Chrome Plated or Polished  
 Rows of Vents: 2  
 Screw Size: #4 R.H.

Fig. 0334



#2



#4A

Finish	Dimensions	Length Louvers	Retail Pkg.	OEM Bulk Pkg.
Chrome	3" x 2-1/2"	2"	0334002DP	0334002CHR
Chrome	7-1/2" x 2-1/2"	3"	033404ADP	033404ACHR
Polished SS	3" x 2-1/2"	2"	0334002DPS	0334002STS
Polished SS	7-1/2" x 2-1/2"	3"	033404ADPS	033404ASTS

**PROP 65 WARNING**  
 (Contains Lead)

### Louver Ventilator

Material: Brass or Stainless Steel  
 Finish: Chrome Plated or Polished  
 Rows of Vents: 3  
 Screw Size: #4 R.H.

Fig. 0335



#9



#3



9A

Finish	Dimensions	Length Louvers	Dealer Pkg.	OEM Bulk Pkg.
Chrome	3" x 3"	2"	0335003DP	0335003CHR
Chrome	8" x 3"	2"	0335009DP	0335009CHR
Chrome	11" x 3-1/2"	3"	033509ADP	033509ACHR
Polished SS	3" x 3"	2"	0335003DPS	0335003STS
Polished SS	8" x 3"	2"	0335009DPS	0335009STS
Polished SS	11" x 3-1/2"	3"	033509ADPS	033509ASTS

**PROP 65 WARNING**  
 (Contains Lead)

7

Deck Plates, Fills, Tank Vents, and Ventilators

## Water Fittings and Deck Plate

### Water Inlet Fitting

#### For Obtaining Water At Dockside

Material: Bronze Body with Black Polymer Watertight Plug and Stainless Steel Bead Chain  
 Finish: Chrome Plated  
 Connection: Standard Female Swivel Hose Connector  
 For Pipe Size: 1/2" NPT  
 O.D. Flange: 2-3/4"  
 Screw Size: #8



Fig. 0499

**Retail Pkg.** 0499DP0CHR  
**OEM Bulk Pkg.** 0499000CHR

Spare Plug with Chain: 0499DP099A.



**! PROP 65 WARNING**  
(Contains Lead)

### Water Outlet Fitting

#### For Use with On-Board Washdown Systems

Material: Bronze Body with Watertight Black Polymer Cap and Stainless Steel Bead Chain  
 Finish: Chrome Plated  
 Connection: Standard Male Hose Connector (MNT)  
 For Pipe Size: 1/2" NPT  
 O.D. Flange: 2-3/4"  
 Screw Size: #8



Fig. 0504

**Retail Pkg.** 0504DP0CHR  
**OEM Bulk Pkg.** 0504000CHR

Spare Cap with Chain: 0504DP099A

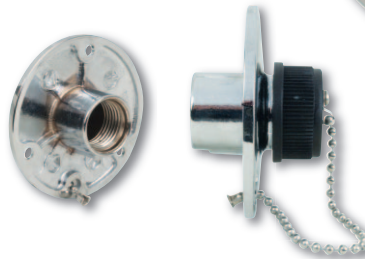

**! PROP 65 WARNING**  
(Contains Lead)

### Regular Deck Plate

Material: Cast Bronze  
 Finish: Plain or Chrome Plated  
 Deck Plate Key: Included

I.D. Opening	O.D. Overall	Plain Standard Pkg.	Chrome Plated Standard Pkg.	Screw Size
3"	5-3/8"	0526003PLB	0526003CHR	10
4"	7-1/16"	0526004PLB	0526004CHR	10
5"	8-3/8"	0526005PLB	0526005CHR	10
6"	9-3/8"	0526006PLB	0526006CHR	1/4"

#### Spare Parts Ordering Information

I.D. Opening	Plain Cap	Chrome Plated Cap	Spare Key Only
3"	0526P0399A	0526C0399A	1248010ZNC
4"	0526P0499A	0526C0499A	0539004PLB
5"	0526P0599A	0526C0599A	0539005PLB
6"	0526P0699A	0526C0699A	0539006PLB

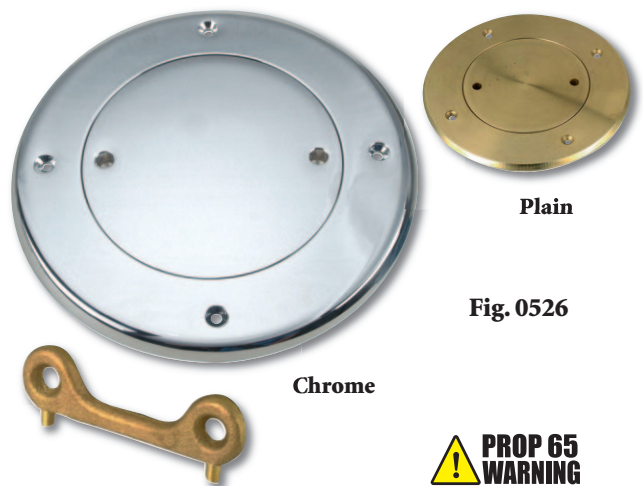

Plain

Fig. 0526

Chrome

**! PROP 65 WARNING**  
(Contains Lead)

## Cleats

### Open Base Cleat

Material: Bronze  
Finish: Chrome Plated



Fig. 0572

Length Overall	Dimensions Base	Max. Rope Size	Mounting Holes Center to Center	Retail Pkg.	Standard Pkg.	Screw Size
8"	4" x 2-1/4"	3/4"	3.25"	0572DP8CHR	0572008CHR	1/4"
10"	5-1/16" x 2-13/16"	7/8"	4.0"	-----	0572010CHR	5/16"
12"	6-1/16" x 2-7/8"	1"	5.0"	-----	0572012CHR	5/16"
15"	7-3/8" x 3-5/8"	1-1/2"	6.0"	-----	0572015CHR	3/8"



### Open Base Cleat

Material: Zinc Alloy  
Finish: Chrome Plated



Fig. 1188

Length Overall	Dimensions Base	Max. Rope Size	Mounting Holes Center to Center	Retail Pkg.	Standard Pkg.	Screw Size
4"	2-1/8" x 1-1/2"	5/16"	1.5"	1188DP4CHR*	1188004CHR	10
6"	3" x 1-3/4"	7/16"	2.25"	1188DP6CHR	1188006CHR	10
8"	4" x 2-1/8"	5/8"	3.2"	1188DP8CHR	1188008CHR	1/4

\* Sold in pairs.

### Open & Closed Base Cleats

Material: Aluminum  
Finish: Plain



Fig. 0545

Open Base

Base Style	Length Overall	Dimensions Base	Max. Rope Size	Retail Pkg.	OEM Bulk Pkg.	Screw Size
Closed	3"	1-1/2" x 5/8"	1/4"	0545DP3ALU*	-----	8
Closed	4"	1-5/8" x 3/4"	5/16"	0545DP4ALU*	-----	10
Closed	5"	2" x 7/8"	3/8"	0545DP5ALU*	-----	1/4"
Closed	6"	2-1/4" x 7/8"	7/16"	0545DP6ALU	0545006ALU	1/4"
Open	8"	2-5/8" x 1-7/8"	5/8"	0545DP8ALU	0545008ALU	1/4"
Open	10"	3-5/8" x 1-1/2"	3/4"	-----	0545010ALU	5/16"
Open	12"	4" x 1-1/2"	7/8"	-----	0545012ALU	5/16"



Closed Base

\*Sold in pairs.

## Cleats

### Streamline Closed Base Cleat

Material: Zinc Alloy  
Finish: Chrome Plated



Fig. 0566

Length Overall	Dimensions Base	Max. Rope Size	Retail Pkg.*	Screw Size
2"	2-3/16" x 1-1/8"	5/16"	0566DP2CHR	6
3"	3-1/8" x 1-1/2"	3/8"	0566DP3CHR	8
4-1/2"	4-7/16" x 1-7/8"	1/2"	0566DP4CHR	10

\*Sold in pairs.

### Open Base Cleat

Material: Zinc Alloy  
Finish: Chrome Plated  
Dimensions: Overall Length: 6-1/2"  
Base: 3" x 1-1/8"  
Screw Size: 1/4"  
Max. Rope Size: 3/4"



Fig. 1252

Retail Pkg.*	OEM Bulk Pkg.
1252DP0CHR	1252000CHR

\*Sold in pairs.

### Open Base Cleat

Material: Aluminum  
Finish: Plain



Fig. 0530

Length Overall	Dimensions Base	Max. Rope Size	Standard Pkg.	Screw Size
8"	4 x 2"-1/4"	3/4"	0530008ALU	1/2"
10"	4-1/2" x 3"	7/8"	0530010ALU	1/2"
12"	6-1/2" x 2-7/8"	1"	0530012ALU	5/8"
15"	7" x 3-1/4"	1-1/2"	0530015ALU	3/4"

## Cleats

### Open Base Cleat

Material: Zinc Alloy with Polymer Base  
 Finish: Chrome Plated with Black Base  
 Screw Size: 1/4"



Fig. 1326

Length Overall	Dimensions Base	Max. Rope Size	Retail Pkg.	OEM Bulk Pkg.
5-3/4"	3-5/8" x 7/8"	1/2"	1326DP2CHR	1326002CHR

### Open Base Cleat

Material: Zinc Alloy, Polymer Base with Stainless Steel Studs, Nuts, and Washers  
 Finish: Chrome Plated with Black Base



Fig. 1316

Length Overall	Max. Rope Size	Catalog Number	Stud Size
4-1/2"	3/8"	1316001CHR	12-24 x 1-1/2"
6"	1/2"	1316002CHR	1/4" x 1-1/2"

### Open Base Cleat

Material: Zinc Alloy with Polymer Base  
 Finish: Chrome Plated with Black Base



Fig. 1306

Length Overall	Max. Rope Size	Retail Pkg.	OEM Bulk Pkg.	Screw Size
4-1/2"	3/8"	1306DP1CHR*	1306001CHR	10
6"	1/2"	1306DP2CHR	1306002CHR	1/4"

\*Sold in pairs.

### Closed Base Cleat

Material: Zinc Alloy with Polymer Base  
 Finish: Chrome Plated with Black Base

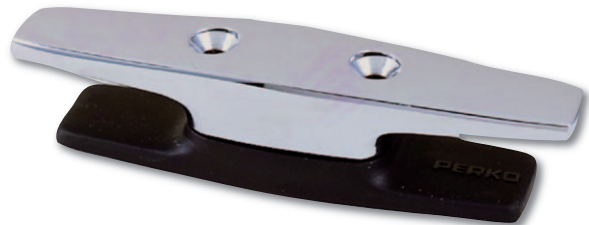

Fig. 1305

Length Overall	Max. Rope Size	Retail Pkg.	Screw Size
4-1/2"	3/8"	1305DP1CHR*	10
6"	1/2"	1305DP2CHR	1/4"

\*Sold in pairs.

## Chocks

### Straight Chock

Material: Bronze  
Finish: Chrome Plated



Fig. 0119

Max. Rope Size	Length Overall	Width	Retail Pkg.	OEM Bulk Pkg.	Screw Size
3/4"	4"	7/8"	0119DP4CHR	0119004CHR	8
1"	6"	1-1/8"	0119DP6CHR	0119006CHR	12



### Straight Chocks

Material: Zinc Alloy  
Finish: Chrome Plated



Fig. 1230

Max. Rope Size	Length Overall	Width	Retail Pkg.	OEM Bulk Pkg.	Screw Size
3/4"	4"	7/8"	1230DP0CHR	1230000CHR	8

Sold in pairs.

### Skene Bow Chocks

#### Port and Starboard Pair

Material: Zinc Alloy  
Finish: Chrome Plated



Fig. 1223

Max. Rope Size	Length Overall	Width	Retail Pkg.	OEM Bulk Pkg.	Screw Size
1/2"	3-1/2"	7/8"	1223DP0CHR	1223000CHR	8

Sold in pairs (Port & Starboard).

## Grab Rail Post, Rigging Tube, Mooring Bit, and Hawse Hole Plate

### Grab Rail Posts

Hollow, For 1 Inch O.D. Tubing

Material: Bronze  
 Finish: Chrome Plated  
 Dimensions: Height Overall: 3-3/8", O.D. Base: 2-1/2"  
 Screw Size: #8



**Fig. 0380**  
End Post



**Fig. 0380A**  
Center Post



Type	Standard Pkg.
End Post	0380000CHR
Center Post	0380A00CHR

### Rigging Tube

For use with 2 Inch I.D. Hose to Pass Wiring Harnesses and Control Cables Through Transoms and Motorwell Bulkheads

Material: Brass and Bronze  
 Finish: Chrome Plated  
 Dimensions: Length Overall: 4-1/8", O.D. Flange: 3-1/8"  
 O.D. Tube: 2"  
 Screw Size: #8  
 Mounting Hole: Mounts in 2-1/8" Inch Diameter Hole



**Fig. 0357**



Retail Pkg.	OEM Bulk Pkg.
0357DP1CHR	0357001CHR

### Mooring Bit - Hollow

Material: Bronze Body with Brass Pin  
 Finish: Chrome Plated



**Fig. 0608**



Dimensions Base	Height	Standard Pkg.	Bolt Size
4-1/4" x 4-1/4"	3-1/2"	0608002CHR	1/4"
5" x 5"	4-3/4"	060802ACHR	3/8"
6" x 6"	5"	0608003CHR	3/8"

### Oval Hawse Hole Plate

Material: Bronze  
 Finish: Chrome Plated  
 Dimensions: Outside: 4-1/4" x 6"  
 Inside: 2-1/8" x 4-1/8"  
 Spigot Length: 1-1/4"  
 Screw Size: 1/4"



**Fig. 0752 Chrome**



Standard Pkg.
0752000CHR



## Rope Deck Pipes, Step Plate, and Fixed Steps

### Rope Deck Pipe

- Material: High Impact, U.V. Stabilized, Fiber Reinforced Polymer  
 Finish: Black or White  
 Dimensions: O.D. Flange: 3-3/4"  
 Max. Rope Size: 7/8"  
 Screw Size: #8  
 Features:
  - Hinged, Snap-Down Cover
  - Hinge Design Allows Open Cover to Lay Flat

Color	Retail Pkg.	OEM Bulk Pkg.
Black	1057DP0BLK	1057000BLK
White	1057DP0WHT	1057000WHT



Fig. 1057 White



Fig. 1057 Black

### Rope Deck Pipe

- Material: Zinc Alloy  
 Finish: Chrome Plated  
 Dimensions: O.D. Flange: 3-3/8"  
 Max. Rope Size: 1"  
 Screw Size: #8  
 Features: Hinged Cover

Retail Pkg.	OEM Bulk Pkg.
0757DP0CHR	0757000CHR



Fig. 0757

### Step Plate

- Material: Zinc Alloy Frame with Soft Polymer Pads  
 Finish: Chrome Plated Frame and Black Pad  
 Screw Size: #8

Dimensions	Retail Pkg.	OEM Bulk Pkg.
8-3/8" x 2-1/4"	1325DP0CHR	1325000CHR
8-3/4" x 3-1/4"	1325DP1CHR	1325001CHR

Sold in pairs.

Spare Pads for Size No. 0: 1050DP0BLK  
 Spare Pads for Size No. 1: 1050DP1BLK

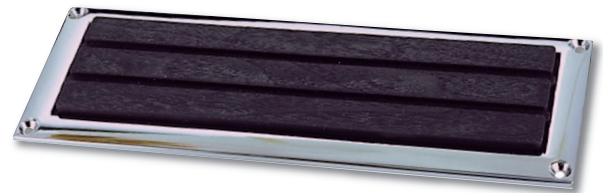

Fig. 1325

### Fixed Steps and Handle

- Material: Bronze  
 Finish: Chrome Plated  
 Bolt Size: 5/16 R.H.



Fig. 0501



Fig. 0351

Dimensions Step	Dimensions Bracket	Retail Pkg.	Standard Pkg.
6" x 4-1/4"	6" x 2"	0351DP0CHR	-----
11" x 4-1/2"	11" x 2"	-----	0501000CHR



## Handles

### Bow Handle for Daysailers

Material: Zinc Alloy  
 Finish: Chrome Plated  
 Dimensions: Length Overall: 6-1/2"  
 Height Above Deck: 2"  
 Screw Size: #8

<b>Retail Pkg.</b> 1234DP0CHR	<b>OEM Bulk Pkg.</b> 1234000CHR
----------------------------------	------------------------------------

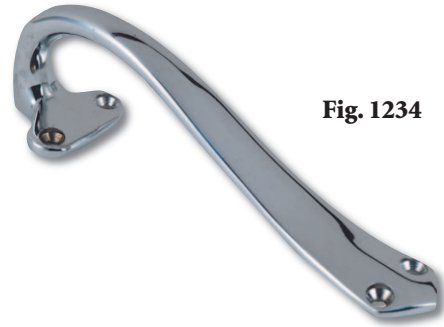

Fig. 1234

### Handle

Material: Zinc Alloy, Polymer Base  
 Finish: Chrome Plated with Black Base  
 Dimensions: Length Overall: 6-1/4", Length Inside: 3-1/2"  
 Height Inside: 1"  
 Screw Size: 1/4"

<b>Retail Pkg.*</b> 1336DP0CHR	<b>OEM Bulk Pkg.</b> 1336000CHR
-----------------------------------	------------------------------------

\*Sold in pairs.

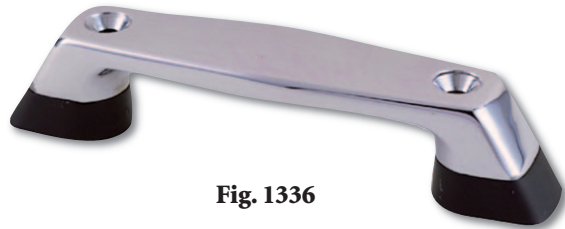

Fig. 1336

### Handle

Material: Zinc Alloy, Polymer Base with Stainless Steel Studs, Nuts and Washers  
 Finish: Chrome Plated with Black Base  
 Dimensions: Length Overall: 6-1/4", Length Inside: 3-1/2"  
 Height Inside: 1"  
 Stud Size: 1/4-20 x 1-1/2"

<b>Standard. Pkg.</b> 1346000CHR
-------------------------------------



Fig. 1346

### Handle

Material: Zinc Alloy  
 Finish: Chrome Plated  
 Dimensions: Length Overall: 6", Length Inside: 3-1/2"  
 Height Inside: 1-5/16"  
 Screw Size: 1/4"

<b>Retail Pkg.*</b> 1231DP0CHR	<b>OEM Bulk Pkg.</b> 1231000CHR
-----------------------------------	------------------------------------

\*Sold in pairs.



Fig. 1231

### Handle

Material: Bronze  
 Finish: Chrome Plated  
 Dimensions: Length Overall: 4-1/4", Length Inside: 2-1/2"  
 Height Inside: 7/8"  
 Screw Size: #6

<b>Retail Pkg.*</b> 0775DP1CHR	<b>OEM Bulk Pkg.</b> 0775001CHR
-----------------------------------	------------------------------------

\*Sold in pairs.



Fig. 0775

# Fender Lock, Hook, Ring Buoy & Boat Hooks and Axe Bracket

## Fender Lock

The Eye is to be Permanently Attached to the Fender Line.

Material: Zinc Alloy  
 Finish: Chrome Plated  
 Dimensions: I.D. Eye: 3/8", O.D. Flange: 1-1/2"  
 Screw Size: #8

Retail Pkg.*	OEM Bulk Pkg.
1299DPOCHR	1299000CHR

\*Sold in pairs.



Fig. 1299

## Snap-Type Fender Hook

Material: Zinc Alloy  
 Finish: Chrome Plated  
 Dimensions: Plate: 1-9/16" x 1-3/8"  
 Max. Rope Size: 1/4"  
 Screw Size: #6

Retail Pkg.*	OEM Bulk Pkg.
1309DPOCHR	1309000CHR

\*Sold in pairs.



Fig. 1309

## Ring Buoy Holder

Material: Brass  
 Finish: Chrome Plated  
 Dimensions: Width Mounting Plate: 3", Height Overall: 4-1/2"  
 Screw Size: #8

Retail Pkg.
1017DPOCHR



Fig. 1017



## Boat Hook Holders

Material: Stainless Steel  
 Dimensions: Length: 3-1/2", Width: 1"  
 Max. Pole O.D.: 1-1/2"  
 Screw Size: #6

Retail Pkg.*	OEM Bulk Pkg.*
0492DPOSTS	0492000STS

\*Sold in pairs.



Fig. 0492

## Axe Bracket

Material: Stainless Steel  
 For Blade Width: 6"  
 Screw Size: Bracket: #6, Socket: 10 R.H.

Retail Pkg.
0325000STS



Fig. 0325  
 Socket & Bracket

## Rowlock Horns and Sockets

### Rowlock Horns

Material: Zinc Alloy  
 Finish: Plain or Chrome Plated  
 Dimensions: O.D. Shank: 1/2"  
 Shank Length: 1-3/4"

- Fig. 1262: Ribbed Open Type
- Fig. 1267: Round Type
- Fig. 1227: North River Type



Type	Finish	Between Horns	I.D. Horns	Retail Pkg.
Ribbed Open	Plain	1-3/4"	-----	1262DP0ZNC
Ribbed Open	Chrome	1-3/4"	-----	1262DP0CHR
Round Open	Plain	-----	2"	1267DP0ZNC
Round Open	Chrome	-----	2"	1267DP0CHR
North River	Plain	1-3/4"	-----	1227DP0ZNC
North River	Chrome	1-3/4"	-----	1227DP0CHR

Sold in pairs.

### Rowlock Sockets

For Use with Figs. 1227, 1262, or 1267 Rowlock Horns

Material: Zinc Alloy with Polymer Bearing  
 Finish: Plain or Chrome Plated  
 Screw Size: #10

- Fig. 1185: Top Mount
- Fig. 1186: Edge Mount
- Fig. 1187: Side Mount



Fig. 1185



Fig. 1186



Fig. 1187

Mount	Finish	Length	Width	Depth	Retail Pkg.*	OEM Bulk Pkg.*
Top	Plain	2-7/8"	1-1/8"	1-1/8"	1185DP0ZNC	1185000ZNC
Top	Chrome	2-7/8"	1-1/8"	1-1/8"	1185DP0CHR	1185000CHR
Edge	Plain	4"	7/8"	1-1/8"	1186DP0ZNC	-----
Edge	Chrome	4"	7/8"	1-1/8"	1186DP0CHR	-----
Side	Plain	4"	-----	1-1/4"	1187DP0ZNC	-----
Side	Chrome	4"	-----	1-1/4"	1187DP0CHR	-----

\*Sold in pairs. Polymer Bearing: 1155000BLK.

## Rowlock Horns and Sockets

### Rowlock Horns

Material: Manganese Bronze  
 Finish: Plain  
 Dimensions: O.D. Shank: 1/2"  
 Shank Length: 2-1/8"

- Fig. 0828: Ribbed Open Type
- Fig. 0829: Round Type
- Fig. 0830: North River Type



Type	Between Horns	I.D. Horns	Retail Pkg.
Ribbed Open	2"	-----	0828DP0PLB
Round	-----	2"	0829DP0PLB
Round	-----	2-1/4"	0829DP1PLB
North River	2-1/8"	-----	0830DP0PLB

Sold in pairs.



### Rowlock Sockets

For Use with Figs. 0828, 0829, or 0830 Rowlock Horns

Material: Manganese Bronze  
 Finish: Plain  
 Screw Size: #10

- Fig. 0831: Top Mount
- Fig. 0832: Side Mount
- Fig. 0833: Edge Mount

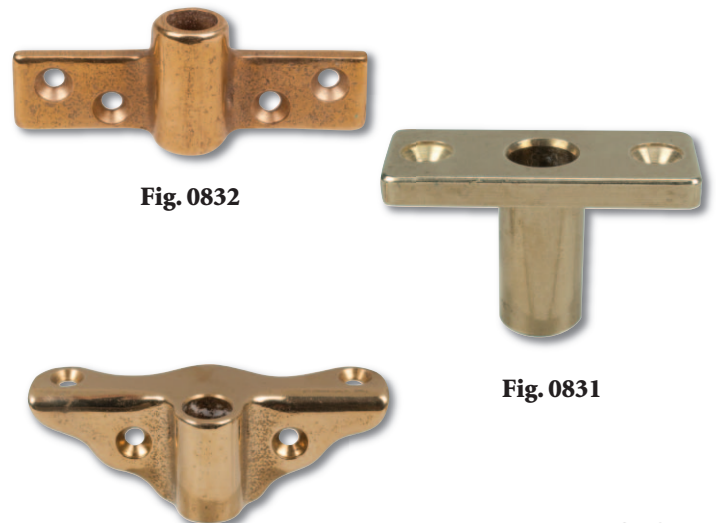

Mount	Length	Width	Depth	Retail Pkg.
Top	2-3/8"	7/8"	1"	0831DP0PLB
Side	3-5/8"	---	1-3/8"	0832DP0PLB
Edge	4"	3/4"	1-3/4"	0833DP0PLB

Sold in pairs.



## Spring Clamps, Hatch Fastener/Windshield Keepers

### Spring Clamps

Material: Stainless Steel  
Screw Size: #6

Min. I.D.	Max. I.D.	Projection	Width Clamp	Retail Pkg.	OEM Bulk Pkg.
5/8"	1-1/4"	1-1/2"	1/2"	0502DP1STS	0502001STS
1"	1-3/4"	2-1/4"	5/8"	0502DP2STS	0502002STS

Sold in pairs.



Fig. 0502

### Hatch Fastener or Windshield Keeper

Material: Brass and Zinc Alloy with Polymer Handle  
Finish: Chrome Plated with Black Handle  
Dimensions: Base: 1-1/2" x 5/8"  
Screw Size: #8

Retail Pkg.	OEM Bulk Pkg.
0769DP0CHR	0769000CHR

**Spare Parts Ordering Information**

Keeper: 076900099A

Handle with Stud: 076900099C



Fig. 0769



### Hatch Fastener or Windshield Keeper

Material: Brass and Zinc Alloy  
Finish: Chrome Plated  
Dimensions: Bracket: 1-1/2" x 5/8"  
Keeper: 1-1/2" x 3/4"  
Bolt Length: 1-1/2"  
Screw Size: #8

Retail Pkg.
0697DP0CHR



Fig. 0697



### Hatch Fastener or Windshield Keeper

Material: Brass and Zinc Alloy with Phosphor Bronze Spring  
Finish: Chrome Plated  
Dimensions: Length Overall: 3-7/8"  
Mounting Base: 1-1/2" x 9/16"  
Screw Size: #6

Retail Pkg.	OEM Bulk Pkg.
0155DP0CHR	0155000CHR



Fig. 0155



## Hatch Support Brace and Windshield Adjusters

### Hatch Support Braces

Material: Brass  
 Finish: Chrome Plated  
 Screw Size: #8  
 Features: One End Angled Base, the Other End Flat Base



Fig. 0762

Port Side Shown



Length Open	Retail Pkg.	OEM Bulk Pkg.
10"	0762DP1CHR	0762001CHR
12"	0762DP2CHR	0762002CHR
14"	0762DP3CHR	0762003CHR

Sold in pairs. (Port & Starboard)

### Windshield Adjuster

Material: Brass and Zinc Alloy with Polymer Knob  
 Finish: Chrome Plated with Black Knob  
 Screw Size: #8



Fig. 1116



Length Rod	O.D. Rod	Retail Pkg.	OEM Bulk Pkg.
8"	3/8"	1116DP1CHR	1116001CHR
10"	3/8"	1116DP2CHR	1116002CHR
12"	3/8"	1116DP3CHR	1116003CHR

Knob: 1117DP0BLK

### Windshield Adjuster - Side or Offset Mounts

Material: Zinc Alloy with Polymer Knob  
 Finish: Chrome Plated with Black Knob  
 Dimensions: Length Overall: 12"  
 Adjustment Length: 9-1/2"  
 Screw Size: #8



Fig. 1290 Side Mount

Fig. 1291 Offset Mount

Mount	Retail Pkg.	OEM Bulk Pkg.
Side Mt.	1290DP0CHR	1290000CHR
Offset Mt.	1291DP0CHR	1291000CHR

Sold in pairs. (Port & Starboard)

NOTE: Illustrations are Port Side.

#### Spare Parts Ordering Information

Figure No.	Port Only	Starboard Only	Mounting Bracket With Knob	Knob Only
1290	1290P0099A	1290S0099A	129000099B	1292000BLK
1291	1291P0099A	1291S0099A	129100099B	1292000BLK



## Rope Clamps, Guides, Dock Line Spring, and Eye Straps

### Rope Clamp

Material: Zinc Alloy  
 Finish: Chrome Plated  
 Dimensions: Length Overall: 1-1/4"  
 Width: 11/16"  
 Rope Size: 1/8" or 3/16"

Retail Pkg.*	OEM Bulk Pkg.
1226DP0CHR	1226000CHR

\*Sold in pairs.



Fig. 1226

### Rope Guides

Material: Zinc Alloy  
 Finish: Chrome Plated  
 Dimensions: I.D. Hole: 5/16"  
 Base: 1-1/4" x 3/4"  
 Screw Size: #6

Retail Pkg.*	OEM Bulk Pkg.
1256DP0CHR	1256000CHR
1261DP0CHR	1261000CHR

\*Sold in pairs.

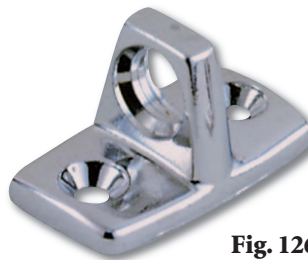

Fig. 1261



Fig. 1256

### Dock Line Spring

Material: Galvanized Spring Steel  
 Dimensions: Length Overall: 10"  
 O.D.: 1-1/2"  
 Compression: 4-1/2"  
 For Rope Size: 1/2"

Standard Pkg.
0759001ZNC



Fig. 0759

### Eye Strap

Material: 300 Series Stainless Steel  
 Dimensions: Length Overall: 1-5/8"  
 I.D. Eye: 1/4"  
 Screw Size: #10

Retail Pkg.*	OEM Bulk Pkg.
0562DP0STS	0562000STS

\*Sold 5 pcs. per card.



Fig. 0562

### Eye Strap

Material: Zinc Alloy  
 Finish: Chrome Plated  
 Dimensions: Length Overall: 1-7/8"  
 I.D. Eye: 5/16"  
 Screw Size: #8

Retail Pkg.*	OEM Bulk Pkg.
1242DP0CHR	1242000CHR

\*Sold 5 pcs. per card.



Fig. 1242



## Hold-Down Clamps

### Lockable Hold-Down Clamps

Material: Bronze  
 Finish: Chrome Plated  
 Features:
 

- All mounting holes covered in closed position
- Lockable

Fig. 0771:
 

- Adjustable "U" bolt, (custom lengths available)
- Flat Mounting
- Great for locking dock boxes

Fig. 1008: • Flat Mounted with all mounting holes covered in closed position

Fig. 1108: • Flat Mounted

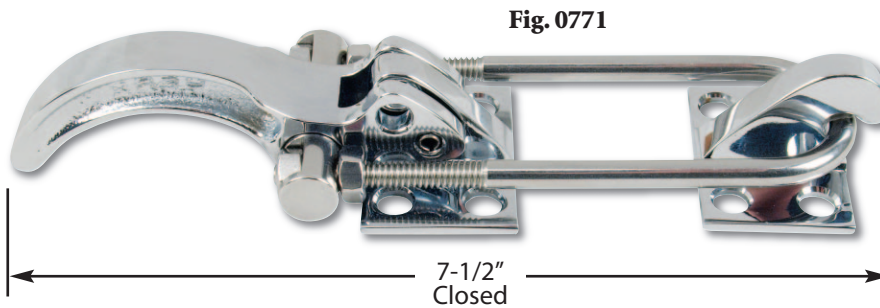

Fig. 0771

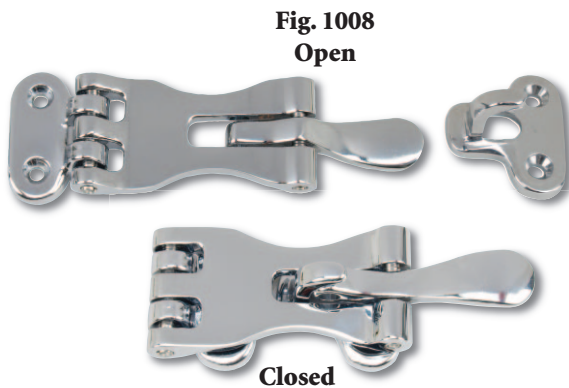

Fig. 1008  
Open

Closed

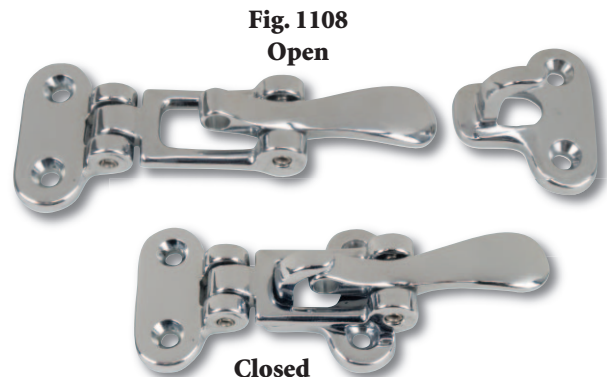

Fig. 1108  
Open

Closed

Adjustable Range	Closed Length	Width	Screw Size	Max. Padlock Shank	Retail Pkg.	OEM Bulk Pkg.
1-11/16"	7-1/2"	2"	10	Up to 5/16"	0771DP0CHR	0771000CHR
-----	4-1/2"	1-3/4"	8	1/4"	1008DP0CHR	1008000CHR
-----	4-1/2"	1-3/4"	6	1/4"	1108DP0CHR	1108000CHR



### Hold-Down Clamps - Flat Mount or Right Angle Mount

Material: Bronze  
 Finish: Chrome Plated  
 Screw Size: #8



Fig. 1112

Fig. 1113

Mount	Length	Width	Retail Pkg	OEM Bulk Pkg.
Flat	3"	1-1/2"	1112DP0CHR	1112000CHR
Right Angle	2-1/2"	1-1/2"	1113DP0CHR	1113000CHR



## Hasps

### Hasp with Swivel Eye

Padlock Eye Swivels to Act as a Latch

Material: Zinc Alloy  
 Finish: Chrome Plated  
 Padlock Clearance: 1 1/32"  
 Screw Size: #6



Fig. 1194

Length Closed	Width Overall	Retail Pkg.	OEM Bulk Pkg.
3"	1"	1194DP0CHR	1194000CHR

**Spare Parts Ordering Information**  
 Keeper: 1194DP099A

### Hasp

Material: Bronze  
 Finish: Chrome Plated  
 Padlock Clearance: 9/32"  
 Screw Size: #6



Fig. 0998

**PROP 65 WARNING**  
 (Contains Lead)

Length Closed	Width Overall	Retail Pkg.	OEM Bulk Pkg.
2"	1"	0998DP1CHR	0998001CHR
3"	1"	0998DP2CHR	0998002CHR

**Spare Parts Ordering Information**  
 Chrome Keeper: 0959DP0CHR

### Hasp

Material: Zinc Alloy  
 Finish: Chrome Plated  
 Padlock Clearance: 1/4"  
 Screw Size: #6



Fig. 1198

Length Closed	Width Overall	Retail Pkg.	OEM Bulk Pkg.
2"	1"	1198DP1CHR	1198001CHR
3"	1"	1198DP2CHR	1198002CHR
3-3/4"	1"	1198DP3CHR	1198003CHR

**Spare Parts Ordering Information**  
 Keepers: 1261DP0CHR

## Butt Hinges

### Butt Hinges with Fast Pin

Material: Heavy Gauge Extruded Brass  
 Finish: Chrome Plated  
 No. of Holes: 6

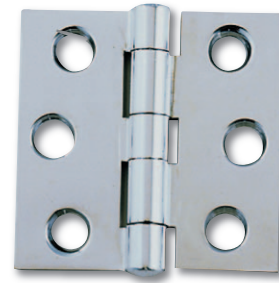

Fig. 1002

Height	Width			Screw
Pin	Open	Retail Pkg.	Standard Pkg.	Size
2"	2"	1002004DP	1002004CHR	6
3"	2"	1002007DP	1002007CHR	8
3"	3"	1002009DP	1002009CHR	10
4"	3"	1002012DP	1002012CHR	10

Sold in pairs.



### Heavy Duty Butt Hinges with Removable Pin

Material: Extruded Brass  
 Finish: Chrome Plated  
 Screw Size: 1/4"  
 No. of Holes: 6  
 Features: Extra Heavy Duty Polymer Bearings for Smooth Operation

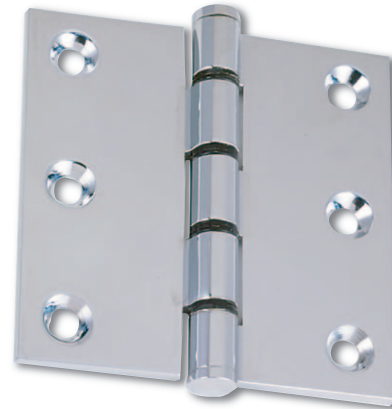

Fig. 1004

Height	Width		
Pin	Open	Retail Pkg.	OEM Bulk Pkg.
4"	4"	1004DP0CHR	1004000CHR

Sold in pairs.



### Butt Hinges with Removable Pin

Material: Heavy Gauge Stamped Brass or Stainless Steel  
 Finish: Chrome Plated or Polished  
 No. of Holes: 6



Fig. 0952

Finish	Height	Width			Screw
	Pin	Open	Retail Pkg.	OEM Bulk Pkg.	Size
Chrome	2-1/2"	2"	0952DP5CHR	0952005CHR	8
Polished SS	2-1/2"	2"	0952DP5STS	0952005STS	8
Chrome	3"	3"	0952DP9CHR	0952009CHR	10
Polished SS	3"	3"	0952DP9STS	0952009STS	10

Sold in pairs.



### Butt Hinges with Fast Pin

Material: Heavy Gauge Stamped Brass or Stainless Steel  
 Finish: Chrome Plated or Polished  
 No. of Holes: 4



Fig. 0949

Finish	Height	Width		Screw
	Pin	Open	Retail Pkg.	Size
Chrome	1-1/2"	1-1/2"	0949DP2CHR	6
Polished SS	1-1/2"	1-1/2"	0949DP2STS	6

Sold in pairs.



## Hinges

### Butt Hinges with Removable Pin

Material: Zinc Alloy  
Finish: Chrome Plated

Height Pin	Width Open	Retail Pkg.	OEM Bulk Pkg.	Screw Size	No. of Holes
1-1/2"	1-1/2"	1293DP2CHR	-----	8	4
2"	1-1/2"	1293DP3CHR	-----	8	4
2"	2"	1293DP4CHR	1293004CHR	8	4
2-1/2"	2"	1293DP5CHR	1293005CHR	8	6
2-1/2"	2-1/2"	1293DP6CHR	1293006CHR	8	6
3"	3"	1293DP9CHR	1293009CHR	10	6

Sold in pairs.

Fig. 1293



Sizes 2, 3, & 4

Sizes 5, 6, & 9

### Butt Hinge with Fixed Pin

Material: Zinc Alloy  
Finish: Chrome Plated  
Dimensions: Height Pin: 1-1/2"  
Width Open: 1-1/2"  
Screw Size: #8

Retail Pkg.	OEM Bulk Pkg.
0941DP0CHR	0941000CHR

Sold in pairs.



Fig. 0941

### Hinge with Fixed Pin

Material: Bronze  
Finish: Chrome Plated  
Dimensions: Height Pin: 1-1/2"  
Screw Size: #8

Width Open	Retail Pkg.	OEM Bulk Pkg.
3"	0951DP1CHR	0951001CHR
4"	0951DP2CHR	0951002CHR

Sold in pairs.



Fig. 0951



### Hinge with Fixed Pin

Material: Zinc Alloy  
Finish: Chrome Plated  
Dimensions: Height Pin: 1-1/2"  
Width Open: 3"  
Screw Size: #8

Retail Pkg.	OEM Bulk Pkg.
0808DP0CHR	0808000CHR

Sold in pairs.



Fig. 0808

## Hinges

### Shortside Hinges with Fixed Pin

Material: Fig. 0987: Bronze  
 Fig. 1213: Zinc Alloy  
 Finish: Chrome Plated  
 Pin Height: 1-1/2"  
 Screw Size: #8

Width Open	Width Shortside	Retail Pkg.	OEM Bulk Pkg.
2-1/4"	3/4"	0987DP1CHR	0987001CHR
2-3/4"	3/4"	0987DP2CHR	-----
2-1/4"	3/4"	1213DP1CHR	1213001CHR

Sold in pairs.



**Fig. 0987**  
 Chrome Plated Bronze

**Fig. 1213**  
 Chrome Plated Zinc Alloy

**! PROP 65 WARNING**  
 (Contains Lead)  
 Fig. 0987

### Offset Shortside Hinge with Fixed Pin

Material: Fig. 0988: Bronze  
 Fig. 1214: Zinc Alloy  
 Finish: Chrome Plated  
 Pin Height: 1-1/2"  
 Offset: 3/8"  
 Screw Size: #8

Width Open	Width Shortside	Retail Pkg.
2-1/4"	3/4"	0988DP1CHR
2-3/4"	3/4"	0988DP2CHR
2-1/2"	3/4"	1214DP1CHR

Sold in pairs.



**Fig. 0988**  
 Chrome Plated Bronze

**Fig. 1214**  
 Chrome Plated Zinc Alloy

**! PROP 65 WARNING**  
 (Contains Lead)  
 Fig. 0988

### Shortside Hinge with Fixed Pin

Material: Bronze  
 Finish: Chrome Plated  
 Pin Height: 1-1/2"  
 Screw Size: #8

Width Open	Width Shortside	Retail Pkg.
3-1/2"	1-1/2"	0999DP0CHR

Sold in pairs.



**Fig. 0999**

**! PROP 65 WARNING**  
 (Contains Lead)

### Offset Hinge with Fixed Pin

Material: Zinc Alloy  
 Finish: Chrome Plated  
 Pin Height: 1-1/2"  
 Screw Size: #8

Width Open	Width Shortside	Retail Pkg.	OEM Bulk Pkg.
1-1/2"	3/8"	0942DP0CHR	0942000CHR

Sold in pairs.



**Fig. 0942**

## Hinges

### Inset and Flush Hinges - Semi Concealed with Fixed Pin

Material: Stamped Brass  
 Finish: Chrome Plated  
 Screw Size: #4  
 Features: Fig 0271: for 3/8" inset doors  
 Fig 0272: for overlay doors

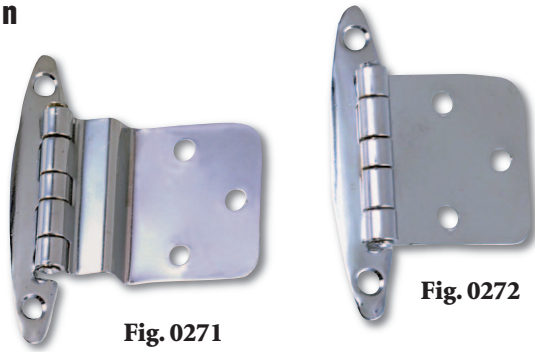

Fig. 0271

Fig. 0272

Dimensions	Retail Pkg.	OEM Bulk Pkg.
2-3/4" x 2-1/2"	0271DP0CHR	0271000CHR
2-3/4" x 1-7/8"	0272DP0CHR	0272000CHR

Sold in pairs.



### Strap Hinge with Fixed Pin

Material: Bronze  
 Finish: Chrome Plated



Fig. 0120

Width Open	Height Pin	Retail Pkg.	Screw Size	No. of Holes
4"	1-1/8"	0120DP1CHR	10	4
6"	1-1/8"	0120DP2CHR	10	6
8"	1-3/8"	0120DP3CHR	12	6

Sold in pairs.



### "T" Hinge

Material: Bronze  
 Finish: Chrome Plated  
 Pin Type: Sizes 1 & 3: Fixed  
 Size 2: Removable Roll Pin



Fig. 0197

Width Open	Height Overall	Width "T" Side	Retail Pkg.	Screw Size	No. of Holes
4"	2-1/8"	1-5/16"	0197DP1CHR	10	6
6"	3"	1-1/2"	0197DP2CHR	10	7
8"	3-7/8"	2"	0197DP3CHR	12	8

Sold in pairs.



## Hinges and Hatch Trim

### Non-Mortised Hinge with Fixed Pin

#### Easily Installs Without Mortising

Material: Stamped Brass or Stainless Steel  
 Finish: Chrome Plated or Polished  
 Dimensions: Width Closed: 7/8"  
 Height Pin: 3-3/8"  
 Screw Size: #8

Finish	Retail Pkg.	OEM Bulk Pkg.
Chrome	0957DP0CHR	0957000CHR
Polished SS	0957DP0STS	0957000STS

Sold in pairs.



Fig. 0957



### Pull Apart Hinges - Left and Right Hand

Use 2 Left Hand or 2 Right Hand For Quick Removal of Hatches, Motor Covers, etc. or Together (1 each Left & Right) as a Heavy Duty Hinge Set.

Material: Bronze  
 Finish: Chrome Plated  
 Dimensions: Length Open: 3-3/4"  
 Width Overall: 2"  
 Screw Size: #10

Type	Retail Pkg.	OEM Bulk Pkg.
Left Hand	0149DP0CHR	0149000CHR
Right Hand	0152DP0CHR	0152000CHR



Fig. 0152  
Right Hand

Fig. 0149  
Left Hand



### Continuous Hinge and Hatch Trim

Material: Stainless Steel  
 Finish: Polished  
 Features:
 

- Holes are two inches apart, center to center
- Fig 0212 - has countersunk holes

#### Continuous Hinge

Width Open	Retail Pkg. One 24" Lgth.	Standard Pkg. in 72" Lengths	Screw Size
1-1/4"	0212DP2STS	0212002STS	5
1-1/2"	0212DP4STS	0212004STS	5

#### Hatch Trim

Width	Length Overall	Standard Pkg.	Screw Size
1-1/4"	72"	0258002STS	6
1-1/2"	72"	0258004STS	6



Fig. 0212



Fig. 0258

## Barrel Bolts

### Slim Barrel Bolt

- Material: Zinc Alloy  
 Finish: Chrome Plated  
 Dimensions: Length: 3-3/4", Width: 3/4"  
 Screw Size: #6  
 Features:
- Fig. 1353: Visible Fasteners
  - Fig. 1354: Hidden Fasteners
  - Integral Friction Pad Eliminates Rattle and Provides Smooth Operation.



Fig. 1353



Fig. 1354

Type	Retail Pkg.	OEM Bulk Pkg.
Visible Fasteners	1353DP0CHR	1353000CHR
Hidden Fasteners	1354DP0CHR	1354000CHR



### Barrel Bolt

- Material: Zinc Alloy  
 Finish: Chrome Plated  
 Dimensions: Length: 3-3/8", Width: 1-1/4"  
 Screw Size: #6 R.H.  
 Features: Integral Friction Pad Eliminates Rattle and Provides Smooth Operation.



Fig. 1244

Retail Pkg.	OEM Bulk Pkg.
1244DP0CHR	1244000CHR



### Barrel Bolt

- Material: Bronze Body with either Bronze Keeper or High Impact Black Nylon Bulkhead Keeper  
 Finish: Chrome Plated  
 Bolt Diameter: 3/8"  
 Screw Size: #6  
 Features:
- Integral Friction Pad Eliminates Rattle and Provides Smooth Operation.
  - Bulkhead Keeper Easily Installs in a 5/8" Hole
  - Retail package includes both styles of keepers

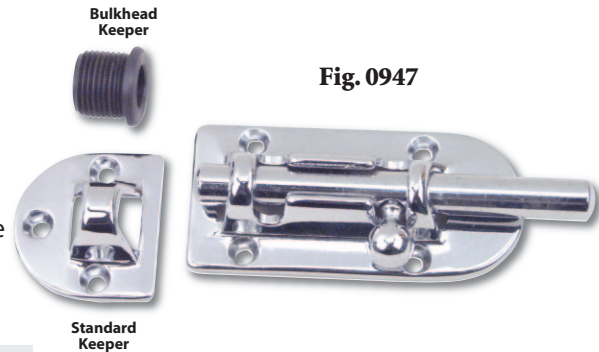

Fig. 0947

Dimensions Overall	OEM Bulk Pkg.		
	Retail Pkg.	Std. Keeper	Bulkhead Keeper
3-7/16" x 1-7/16"	0947DP1CHR	0947001CHR	0947B01CHR
4-5/16" x 1-7/16"	0947DP2CHR	0947002CHR	0947B02CHR
5-1/4" x 1-7/16"	0947DP3CHR	0947003CHR	0947B03CHR



Extra long barrel options are available. Contact the factory for more information



Extra Long Barrel Bolt with 2-1/2" Throw (Shown Open)

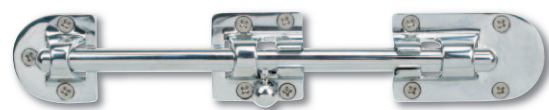

Extra Long Barrel Bolt with 2-1/2" Throw (Shown Closed)



## Ship Bolt and Cabin Door Hooks

### Ship Bolt

Material: Bronze  
 Finish: Chrome Plated  
 Dimensions: Length: 2-5/8", Width: 1-1/4"  
 Screw Size: #6  
 Features: Includes Brass Friction Spring to Eliminate Rattle and Provide Detented Operation

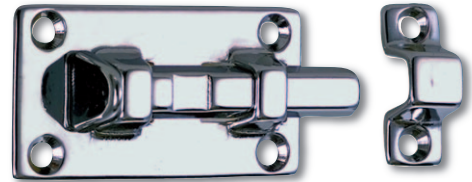

Fig. 1053

Retail Pkg.	OEM Bulk Pkg.
1053DP0CHR	1053000CHR



### Cabin Door Hook

Material: Bronze  
 Finish: Plain or Chrome Plated  
 Screw Size: #6

Length Hook	Chrome Plated Retail Pkg.	Chrome Plated OEM Bulk Pkg.	Plain Standard
1-1/2"	0956DP1CHR	0956001CHR	0956001PLB
2"	0956DP2CHR	0956002CHR	0956002PLB
2-1/2"	0956DP3CHR	0956003CHR	0956003PLB
3"	0956DP4CHR	0956004CHR	0956004PLB
3-1/2"	0956DP5CHR	-----	0956005PLB
4"	0956DP6CHR	0956006CHR	0956006PLB
5"	0956DP7CHR	0956007CHR	0956007PLB
6"	0956DP8CHR	0956008CHR	0956008PLB



Fig. 0956



#### Spare Parts Ordering Information

Bronze Keepers (2 per card): 0959DP0PLB  
 Chrome Keepers (2 per card): 0959DP0CHR  
 Chrome Keepers OEM Bulk (100 pcs.): 0959000CHR



### Cabin Door Hook

Material: Zinc Alloy  
 Finish: Chrome Plated  
 Screw Size: #6

Length Hook	Retail Pkg.	OEM Bulk Pkg.
1-3/4"	1199DP1CHR	1199001CHR
2-1/4"	1199DP2CHR	1199002CHR
3"	1199DP3CHR	1199003CHR
4"	1199DP4CHR	1199004CHR



Fig. 1199



#### Spare Parts Ordering Information

Keepers (2 per card): 1261DP0CHR

### Cabin Door Hook

Material: Zinc Alloy  
 Finish: Chrome Plated  
 Screw Size: #6

Length Hook	Retail Pkg.	OEM Bulk Pkg.
2"	1287DP1CHR	1287001CHR
2-1/2"	1287DP2CHR	1287002CHR
3"	1287DP3CHR	1287003CHR



Fig. 1287



#### Spare Parts Ordering Information

Keepers (2 per card): 1261DP0CHR

## Door Stops, Holder, and Buttons

### Door Stop and Holder

Material: Bronze with Rubber Bumper  
 Finish: Chrome Plated  
 Screw Size: Door Stop: #8  
 Keeper: #6



Fig. 0574

**PROP 65 WARNING**  
 (Contains Lead & DINP)

Length	O.D.	Retail Pkg.	OEM Bulk Pkg.
2-3/8"	1-3/4"	0574DP1CHR	0574001CHR
3-1/4"	1-3/4"	0574DP2CHR	0574002CHR

### Door Stop

Material: Zinc Alloy with Rubber Bumper  
 Finish: Chrome Plated  
 Screw Size: #4



Fig. 1177

**PROP 65 WARNING**  
 (Contains DINP)

Length	O.D.	Retail Pkg.	OEM Bulk Pkg.
1"	1-1/4"	1177DP0CHR	1177000CHR

### Door Holder

Material: Stainless Steel Clip, Zinc Alloy Arrow  
 Finish: Chrome Plated  
 Screw Size: #8

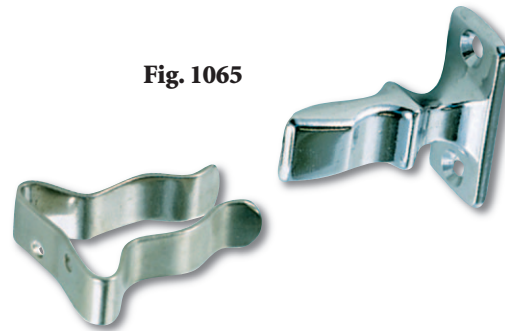

Fig. 1065

Dimensions Arrow Base	Dimensions Clip Base	Projection	Retail Pkg.
1-5/8" x 3/4"	1-3/8" x 7/16"	1-3/4"	1065DP0CHR

### Door Buttons

Material: Zinc Alloy with Black Polymer Button  
 Finish: Chrome Plated  
 Screw Size: #6  
 Features: Fig. 1216: Supplied with Phosphor Bronze Tension Spring  
 Fig. 1217: Supplied without Spring and Requires a No. 4 Oval-Head Pivot Screw



Fig. 1216



Fig. 1217

Type	O.D. Overall	Retail Pkg.	OEM Bulk Pkg.
With Spring	1-3/4"	1216DP0CHR	1216000CHR
w/o Spring	1-3/4"	1217DP0CHR	1217000CHR

#### Spare Parts Ordering Information

Button for Both: 121600099A.

## Door Catches and Slam Cam Bar

### Door Catch

Material: Polymer with Stainless Steel Mounting & Keeper Screws  
 Finish: White  
 Screw Size: 3/4" x #8  
 Dimensions: 1-1/4" x 5/8"



Fig. 0554

<b>Retail Pkg.</b> 0554DP	<b>OEM Bulk Pkg.</b> 0554
------------------------------	------------------------------

### Door Catch

Material: Polymer  
 Finish: Black  
 Screw Size: #4 R.H.  
 Dimensions: Stud: 1-1/8" x 3/8"  
 Catch: 1-3/8" x 7/8"



Fig. 0559

<b>Retail Pkg.</b> 0559DP	<b>OEM Bulk Pkg.</b> 0559
------------------------------	------------------------------

### Slam Cam Bar with Emergency Hatch Release

Material: Zinc-Alloy with Polymer Release Knob and Strike  
 Finish: Chrome Plated Body, Black Strike  
 Screw Size: #10-24  
 Dimensions: Length: 3-1/2"  
 Adjustments:  
 See Diagram (A) Strike Box: Horizontal - 5/16"  
 (B) Strike Box: Vertical - 1/2"  
 (C) Cam Bar: Vertical - 1"  
 (D) Cam Bar: Lateral - 9/16"

<b>Retail Pkg.</b> 1075DP7CHR	<b>OEM Bulk Pkg.</b> 1075007CHR
----------------------------------	------------------------------------

#### Cam Bar Adjustment Diagram

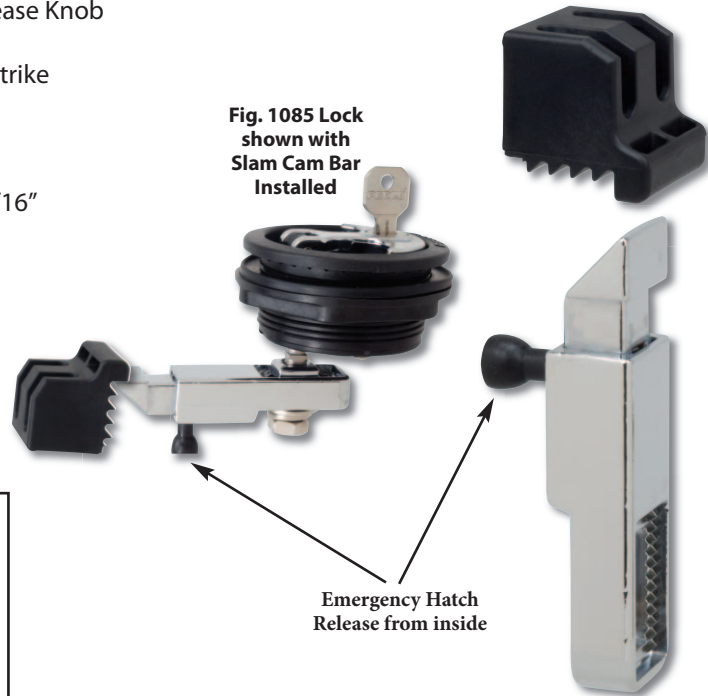
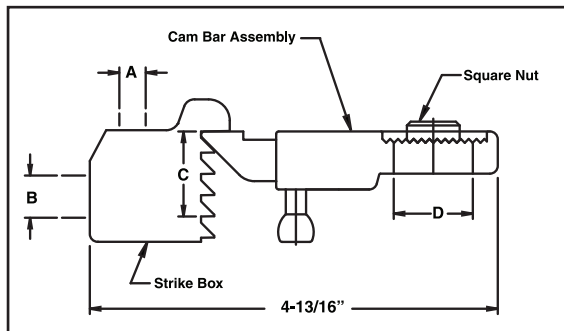

Fig. 1085 Lock shown with Slam Cam Bar Installed

Emergency Hatch Release from inside

Fig. 1075

## “T” Handle Lock with Draw-Down Cam Bar

### Surface Mount “T” Handle Lock with Draw-down Cam Bar

Pushing the handle down pulls the cam bar up

- Material: Polymer Body with Zinc Alloy “T” Handle and Stainless Steel Stem
- Finish: Black, White or Ivory Body with Chrome Plated “T” Handle
- Draw-Down: 1/4”
- Installation: Mounting Hole Diameter: 2-1/2”  
Face Plate Diameter: 3”  
For Mounting Surfaces: 1/8” to 3/4”
- Features:
  - Gasket Included for Smooth Surface Applications
  - Handle does not lay flat in open, unlocked position

**NEW  
PRODUCT**



**Fig. 1086**  
shown with No. 5  
Extra Long Cam Bar

Body Color	Adjustment Cam Bar	OEM Bulk Pkg.	Retail Pkg.
Black	3/4" to 2-3/8"	1086001BLK	1086DP1BLK
Black	1-1/4" to 1-7/8"	1086003BLK	1086DP3BLK
Black	1/2" to 3"	1086004BLK	1086DP4BLK
Black	1-1/4" to 2"	1086005BLK	1086DP5BLK
Black	1-1/8" to 2"	1086006BLK	1086DP6BLK
Black	See Page R-153	1086007BLK	1086DP7BLK
White	3/4" to 2-3/8"	1086001WHT	1086DP1WHT
White	1-1/4" to 1-7/8"	1086003WHT	1086DP3WHT
White	1/2" to 3"	1086004WHT	1086DP4WHT
White	1-1/4" to 2"	1086005WHT	1086DP5WHT
White	1-1/8" to 2"	1086006WHT	1086DP6WHT
White	See Page R-153	1086007WHT	1086DP7WHT
Ivory	3/4" to 2-3/8"	1086001IVR	-----
Ivory	1-1/4" to 1-7/8"	1086003IVR	-----
Ivory	1/2" to 3"	1086004IVR	-----
Ivory	1-1/4" to 2"	1086005IVR	-----
Ivory	1-1/8" to 2"	1086006IVR	-----
Ivory	See Page R-153	1086007IVR	-----

### Draw-Down Feature

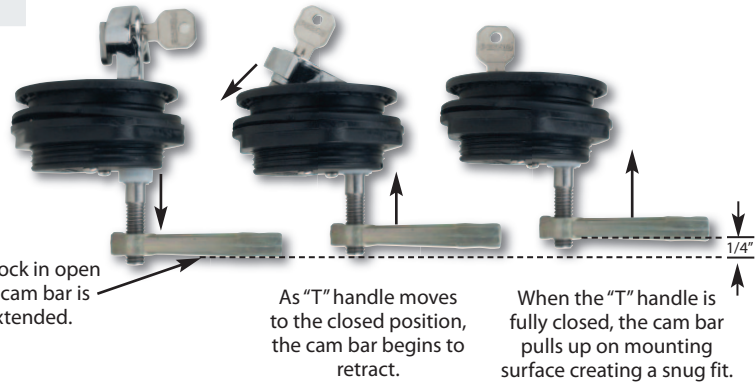

### Spare Parts Ordering Information

#### Threaded Shaft Cam Bars

- Offset: 109100188A
- Straight: 109100388A
- Extra Long Offset: 109100488A
- Extra Long Straight: 109100588A
- Extra Long Offset: 109100688A
- Slam Cam: 1075007CHR or 1075DP7CHR



Consult factory for custom colors matches

### Cam Bar Options

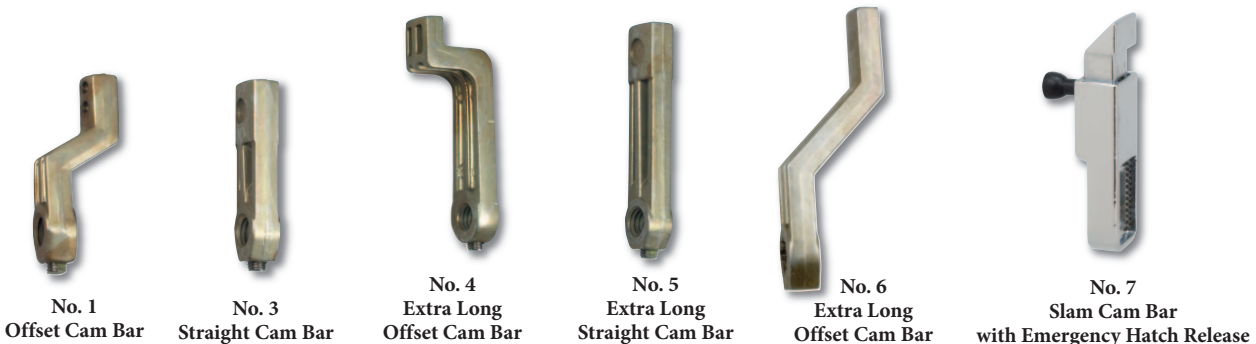

## “T” Handle Surface Mount Lock

### Surface Mount “T” Handle Locks

Gasket Included for Smooth Surface Applications

- Material: Polymer Body with either Zinc Alloy or Polymer “T” Handle and Stainless Steel Stem
- Finish: Black, White or Ivory Body with either Chrome Plated, Black or White “T” Handle
- Installation: Mounting Hole Diameter: 2-1/2”  
Face Plate Diameter: 3”  
For Mounting Surfaces: 1/8” to 3/4”
- Features:
- Gasket Included for Smooth Surface Applications
  - Handle will lay flat in open, unlocked position.

**Fig. 1085**  
shown with No. 1  
Offset Cam Bar

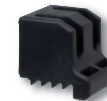

**Fig. 1085 Lock**  
shown with No. 7  
Slam Cam Bar

Emergency Hatch  
Release from inside

Body Color	Adjustment Cam Bar	OEM Bulk Pkg.	Retail Pkg.
Black	3/4" to 2-3/8"	1085001BLK	1085DP1BLK
Black	1-1/4" to 1-7/8"	1085003BLK	1085DP3BLK
Black	1/2" to 3"	1085004BLK	1085DP4BLK
Black	1-1/4" to 2"	1085005BLK	1085DP5BLK
Black	1-1/8" to 2"	1085006BLK	1085DP6BLK
Black	See Page R-153	1085007BLK	1085DP7BLK
White	3/4" to 2-3/8"	1085001WHT	1085DP1WHT
White	1-1/4" to 1-7/8"	1085003WHT	1085DP3WHT
White	1/2" to 3"	1085004WHT	1085DP4WHT
White	1-1/4" to 2"	1085005WHT	1085DP5WHT
White	1-1/8" to 2"	1085006WHT	1085DP6WHT
White	See Page R-153	1085007WHT	1085DP7WHT
Ivory	3/4" to 2-3/8"	1085001IVR	1085DP1IVR
Ivory	1-1/4" to 1-7/8"	1085003IVR	1085DP3IVR
Ivory	1/2" to 3"	1085004IVR	1085DP4IVR
Ivory	1-1/4" to 2"	1085005IVR	1085DP5IVR
Ivory	1-1/8" to 2"	1085006IVR	1085DP6IVR
Ivory	See Page R-153	1085007IVR	1085DP7IVR

**NEW  
COLOR  
Ivory**

Consult factory for custom colors matches



#### Spare Parts Ordering Information

- Threaded Shaft Cam Bars**  
Offset: 109100188A  
Straight: 109100388A  
Extra Long Offset: 109100488A  
Extra Long Straight: 109100588A  
Extra Long Offset: 109100688A  
Slam Cam: 1075007CHR or 1075DP7CHR



Consult factory for custom colors matches

### Cam Bar Options



No. 1  
Offset Cam Bar



No. 3  
Straight Cam Bar



No. 4  
Extra Long  
Offset Cam Bar



No. 5  
Extra Long  
Straight Cam Bar



No. 6  
Extra Long  
Offset Cam Bar



No. 7  
Slam Cam Bar  
with Emergency Hatch Release

## “T” Handle Surface Mount Locks, Latches, and Pull

### Surface Mount “T” Handle Locks, Latches and Pull

Gasket Included for Smooth Surface Applications, Toothed Back for Carpet Surface Applications

- Material:** Polymer Body with either Zinc Alloy or Polymer “T” Handle and Stainless Steel Stem
- Finish:** Black, White or Ivory Body with either Chrome Plated, Black or White “T” Handle
- Installation:** Mounting Hole Diameter: 2-1/2”  
Face Plate Diameter: 3”  
For Mounting Surfaces: 1/8” to 3/4”
- Features:** Fig. 1091: Lock with 2 keys  
Fig. 1092: Latch, non-locking  
Fig. 1093: Pull



**Fig. 1091 #1**  
White/Chrome  
Shown

The T - Handle Drops Down Flush in Either the Open or Closed (180° Rotation) Position (Except with the Offset Cam Bar Positioned Upward)

#### Mounting Options:



Surface Mount



Upholstery Mount



Carpet Mount

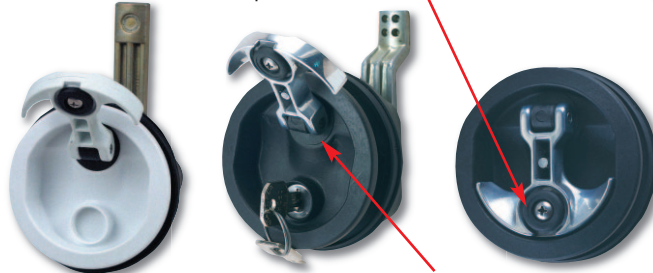

Latch Version

Lock Version

Rubber Seal

The Rubber Seal & Boot Under the T - Handle Seals the Lock Cylinder Preventing Water Intrusion



Consult factory for custom colors matches



**Fig. 1093 Pull**

### Cam Bar Options



No. 1  
Offset Cam Bar

No. 3  
Straight Cam Bar

No. 4  
Extra Long  
Offset Cam Bar

No. 5  
Extra Long  
Straight Cam Bar

No. 6  
Extra Long  
Offset Cam Bar

No. 7  
Slam Cam Bar  
with Emergency Hatch Release



## “T” Handle Surface Mount Locks, Latches, and Pull

Type	Body Color	Handle Color	Adjustment Cam Bar Inches	OEM Bulk Pkg.	Retail Pkg.
Lock	Black	Chrome	No Cam Bar	1091001BLK	1091DP0BLK*
			3/4" to 2-3/8"	1091003BLK	1091DP1BLK
			1-1/4" to 1-7/8"	1091004BLK	1091DP3BLK
			1/2" to 3"	1091005BLK	1091DP4BLK
			1-1/4" to 2"	1091006BLK	1091DP5BLK
			1-1/8" to 2"	1091007BLK	1091DP6BLK
Lock	Black	Black	3/4" to 2-3/8"	1091B01BLK	-----
			1-1/4" to 1-7/8"	1091B03BLK	-----
			1/2" to 3"	1091B04BLK	-----
			1-1/4" to 2"	1091B05BLK	-----
			1-1/8" to 2"	1091B06BLK	-----
			See Page 153	1091B07BLK	-----
Lock	White	Chrome	No Cam Bar	1091001WHT	1091DP0WHT*
			3/4" to 2-3/8"	1091003WHT	1091DP1WHT
			1-1/4" to 1-7/8"	1091004WHT	1091DP3WHT
			1/2" to 3"	1091005WHT	1091DP4WHT
			1-1/4" to 2"	1091006WHT	1091DP5WHT
			1-1/8" to 2"	1091007WHT	1091DP6WHT
Lock	White	White	3/4" to 2-3/8"	1091W01WHT	-----
			1-1/4" to 1-7/8"	1091W03WHT	-----
			1/2" to 3"	1091W04WHT	-----
			1-1/4" to 2"	1091W05WHT	-----
			1-1/8" to 2"	1091W06WHT	-----
			See Page 153	1091W07WHT	-----
Lock	Ivory	Chrome	3/4" to 2-3/8"	1091001IVR	<b>NEW COLOR</b> Ivory
			1-1/4" to 1-7/8"	1091003IVR	
			1/2" to 3"	1091004IVR	
			1-1/4" to 2"	1091005IVR	
			1-1/8" to 2"	1091006IVR	
			See Page 153	1091007IVR	
Latch	Black	Chrome	No Cam Bar	1092001BLK	1092DP0BLK*
			3/4" to 2-3/8"	1092003BLK	1092DP1BLK
			1-1/4" to 1-7/8"	1092004BLK	1092DP3BLK
			1/2" to 3"	1092005BLK	1092DP4BLK
			1-1/4" to 2"	1092006BLK	1092DP5BLK
			1-1/8" to 2"	1092007BLK	1092DP6BLK
Latch	Black	Black	3/4" to 2-3/8"	1092B01BLK	-----
			1-1/4" to 1-7/8"	1092B03BLK	-----
			1/2" to 3"	1092B04BLK	-----
			1-1/4" to 2"	1092B05BLK	-----
			1-1/8" to 2"	1092B06BLK	-----
			See Page 153	1092B07BLK	-----
Latch	White	Chrome	No Cam Bar	1092001WHT	1092DP0WHT*
			3/4" to 2-3/8"	1092003WHT	1092DP1WHT
			1-1/4" to 1-7/8"	1092004WHT	1092DP3WHT
			1/2" to 3"	1092005WHT	1092DP4WHT
			1-1/4" to 2"	1092006WHT	1092DP5WHT
			1-1/8" to 2"	1092007WHT	1092DP6WHT
Latch	White	White	3/4" to 2-3/8"	1092W01WHT	-----
			1-1/4" to 1-7/8"	1092W03WHT	-----
			1/2" to 3"	1092W04WHT	-----
			1-1/4" to 2"	1092W05WHT	-----
			1-1/8" to 2"	1092W06WHT	-----
			See Page 153	1092W07WHT	-----
Latch	Ivory	Chrome	3/4" to 2-3/8"	1092001IVR	<b>NEW COLOR</b> Ivory
			1-1/4" to 1-7/8"	1092003IVR	
			1/2" to 3"	1092004IVR	
			1-1/4" to 2"	1092005IVR	
			1-1/8" to 2"	1092006IVR	
			See Page 153	1092007IVR	
Pull	Black	Black	3"	1093000BLK	
Pull	Black	Chrome	3"	1093000CHR	
Pull	White	White	3"	1093000WHT	



Deck and Cabinet Hardware, Hinges, Locks & Latches

\* Dealers Order with Cam Bar Assortment: 1091DP099A Consult factory for custom colors

### Spare Parts Ordering Information

#### Threaded Shaft Cam Bars

Offset: 109100188A  
 Straight: 109100388A  
 Extra Long Offset: 109100488A  
 Extra Long Straight: 109100588A  
 Extra Long Offset: 109100688A  
 Slam Cam: 1075007CHR or 1075DP7CHR

#### Old Style Square Shaft Cam Bars

Offset: 109100199A  
 Straight: 109100399A  
 Extra Long Offset: 109100499A  
 Extra Long Straight: 109100599A



## Flush Locks & Latches

### Surface Mount Flush Locks and Latches

- Material: Polymer Body with Zinc Alloy Handle and Stainless Steel Stem and Lock Nut
- Finish: Black or White Body with Chrome Plated Handle
- Dimensions: Face Plate: 2-1/2" x 2-1/2"
- For Door Thickness: 1/4" to 1-1/8"
- Installation: Mounting Hole Diameter: 2"
- Features:
- Detents indicate open or closed position.
  - Size No. 1: Offset cam bar and flexible polymer strike
  - Size No. 2: Offset adjustable cam bar
  - Size No. 3: Straight cam bar and flexible polymer strike

Fig. 0931: Lock with 2 keys  
 Fig. 0932: Latch, non-locking



Fig. 0932 #2    Fig. 0931 #3

Type	Adjustment Cam Bar	Black Retail Pkg.	White Retail Pkg.	Black OEM Bulk Pkg.	White OEM Bulk Pkg.
Lock	3/8" to 3"	0931DP1BLK	0931DP1WHT	0931001BLK	0931001WHT
Lock	3/8" to 3"	0931DP2BLK	0931DP2WHT	0931002BLK	0931002WHT
Lock	1-1/16" to 2-9/16"	0931DP3BLK	0931DP3WHT	0931003BLK	0931003WHT
Latch	3/8" to 3"	0932DP1BLK	0932DP1WHT	0932001BLK	0932001WHT
Latch	3/8" to 3"	0932DP2BLK	0932DP2WHT	0932002BLK	0932002WHT
Latch	1-1/16" to 2-9/16"	0932DP3BLK	0932DP3WHT	0932003BLK	0932003WHT

#### Spare Parts Ordering Information

Offset Cam Bar: 093100199A    Offset Adjustable Cam Bar: 093100299A  
 Straight Cam Bar: 093100399A    Flexible Polymer Strike: 093100099B



### Surface Mount Flush Locks and Latches

- Material: Polymer Body with Zinc Alloy Handle and Stainless Steel Stem and Lock Nut
- Finish: Black or White Body with Chrome Plated Handle
- Dimensions: Face Plate: 3-1/8" x 3-1/8"
- For Door Thickness: 1/8" to 3/4"
- Installation:
- Flush mounts in a 2-3/8" x 2-3/8" hole
  - Surface mounts in a 1-5/8" diameter hole with polymer spacer (included)
- Features:
- Large handle allows two finger grip

Fig. 1031: Lock with 2 keys  
 Fig. 1032: Latch, non-locking

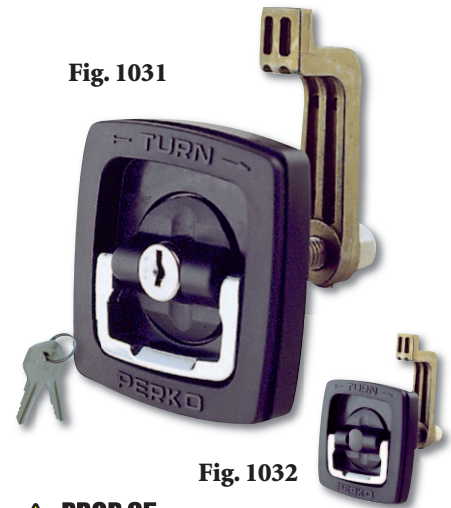

Type	Adjustment Cam Bar	Black Retail Pkg.	White Retail Pkg.	Black OEM Bulk Pkg.	White OEM Bulk Pkg.
Lock	1/2" to 3"	1031DP1BLK	1031DP1WHT	1031001BLK	1031001WHT
Latch	1/2" to 3"	1032DP1BLK	1032DP1WHT	1032001BLK	1032001WHT

#### Spare Parts Ordering Information

Offset Cam Bar For 1031/1032: 103100499A



### Lock and Latch Cover

- Material: Fiber Reinforced Polymer
- Finish: Black or White
- Features: Hinged, water resistant



Fig. 1089

Color	Fits Fig. No.	Overall Dimensions	Retail Pkg.	OEM Bulk Pkg.
Black	0931/0932	2-3/4" x 3-1/4"	1089DP1BLK	1089001BLK
White	0931/0932	2-3/4" x 3-1/4"	1089DP1WHT	1089001WHT
Black	1031/1032	3-1/4" x 3-3/4"	1089DP3BLK	1089003BLK
White	1031/1032	3-1/4" x 3-3/4"	1089DP3WHT	1089003WHT



## Flush Locks & Latches

### Surface Mount Flush Locks and Latches For Carpet or Smooth Surface Applications

- Material:** Polymer Body with Stainless Steel "D" Ring Handle, Stem and Lock Nut
- Finish:** Black or White Body
- Dimensions:** Face Plate: 2-7/8" x 2-7/8"
- Mounting Surface:** 3/8" to 7/8"
- Installation:** Mounting Hole: 2-3/8" Diameter
- Features:**
- Position indicator shows open or closed position
  - Two o-rings for increased water resistance
  - Size No. 1: Offset cam bar and flexible polymer strike
  - Size No. 2: Offset adjustable cam bar
  - Size No. 3: Straight cam bar and flexible polymer strike

- Fig. 1071: Lock with 2 keys (For carpet surface applications only)
- Fig. 1072: Latch, non-locking (For carpet surface applications only)
- Fig. 1081: Lock with 2 keys (includes gasket for smooth surface applications)
- Fig. 1082: Latch-non-locking (includes gasket for smooth surface applications)



Fig. 1071 #1  
Shown



Fig. 1072 #2  
Shown



Fig. 1081 #3  
Shown

Color	Type	Adjustment Cam Bar	Carpet Only		Carpet or Smooth Surface	
			Figs. 1071/1072 OEM Bulk Pkg.	Figs. 1081/1082 Retail Pkg.	Figs. 1081/1082 OEM Bulk Pkg.	
Black	Lock	3/8" to 3"	1071001BLK	1081DP1BLK	1081001BLK	
Black	Lock	3/8" to 3"	1071002BLK	1081DP2BLK	1081002BLK	
Black	Lock	1-1/16" to 2-9/16"	1071003BLK	1081DP3BLK	1081003BLK	
Black	Latch	3/8" to 3"	1072001BLK	1082DP1BLK	1082001BLK	
Black	Latch	3/8" to 3"	1072002BLK	1082DP2BLK	1082002BLK	
Black	Latch	1-1/16" to 2-9/16"	1072003BLK	1082DP3BLK	1082003BLK	
White	Lock	3/8" to 3"	1071001WHT	1081DP1WHT	1081001WHT	
White	Lock	3/8" to 3"	1071002WHT	1081DP2WHT	1081002WHT	
White	Lock	1-1/16" to 2-9/16"	1071003WHT	1081DP3WHT	1081003WHT	
White	Latch	3/8" to 3"	1072001WHT	1082DP1WHT	1082001WHT	
White	Latch	3/8" to 3"	1072002WHT	1082DP2WHT	1082002WHT	
White	Latch	1-1/16" to 2-9/16"	1072003WHT	1082DP3WHT	1082003WHT	

Flexible  
Polymer  
Strike



#### Spare Parts Ordering Information

- Offset Cam Bar: 093100199A      Offset Adjustable Cam Bar: 093100299A  
 Straight Cam Bar: 093100399A      Flexible Polymer Strike: 093100099B



## Self Adjusting Slam Latch and Cam Bar Selection Guide

### Self Adjusting Slam Latch - Patent No. 7,066,504

Material: Polymer Body and Strike  
 Finish: Black or White  
 Dimensions: Face Plate: 2-3/8" O.D.  
 Mounting Surface: 1/8" to 3/4"  
 Installation: 2" Diameter Hole  
 Features: **Unique to PERKO**

- "PERKO leak proof" slide action design keeps inside of hatches dry
- Self-adjusting, ratcheting cam bar/strike permits installations with slight misalignment of components
- Includes an emergency hatch release from inside the compartment
- Similar in look to popular PERKO Fig. 1091 series
- Simple one nut installation
- Retail package includes 2 strikes to accommodate a variety of mounting configurations

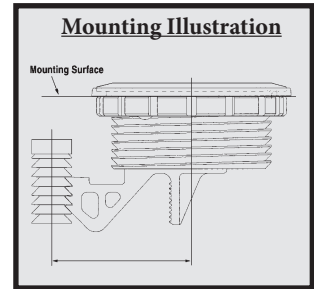

Fig. 0675

Black



Self-Adjusting, Ratcheting Slide Action Design



Adjustment	Retail Pkg.	OEM Bulk Pkg.
Cam Bar 1/8 to 3/4	0675DPBBLK	0675B00BLK
1/8 to 3/4	0675DPWWHT	0675W00WHT

### UPHOLSTERY TRIM RING BLACK OR WHITE POLYMER



Fig. 1097 Upholstery Trim Ring



Detail Showing Available Upholstery Mounting Ring Contact Factory for details

### CAM BAR SELECTION GUIDE

Cam Bars for 0931/0932, 1071/1072 and 1081/1082 Series Lock & Latch Sets with 5/16" Shafts



Cam Bars for 1085, 1091/92, 1094/95 and 1031/1032 Series Lock & Latch Sets with 3/8" Shafts



Measurements are from the center of the lock set to the top of the cam bar shaft end.  
 \*Note: 1091/1092 series have offset center shafts, add 5/8" for Dimension from center.

## Shower Door Latches

### Shower Door Latch Sets

- Material: Brass and Zinc Alloy Components  
 Finish: Chrome Plated  
 For Glass Thickness: : 5/16" to 1/2"  
 Installation: Mounting Hole Diameter: 7/8"  
 Features:
- 180° and 135° cam bar options
  - Slotted strike or "J" hook installation options
  - Provides closure by latching door in glass-to-wall or glass-to-glass installations
  - Centers the door in out-of-alignment situations
  - Positive zero degree closure
  - Operational from both sides of the door
  - Internal ball point indexing mechanism keeps the knob from "free-spinning"

Fig. 0740: Round knobs with grip detents

Fig. 0743: Tapered body cylinder with "L" shaped horizontal handles

Fig. 0744: Round body cylinder with "L" shaped vertical handles

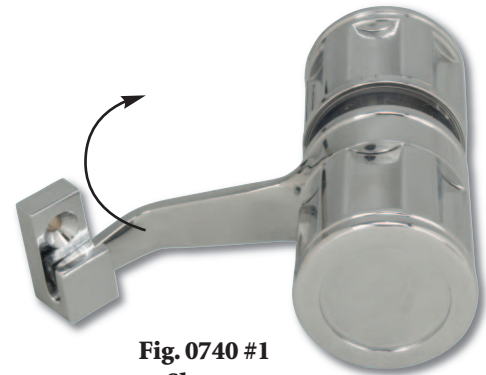

**Fig. 0740 #1 Shown**



**Fig. 0743 #1 Shown**



**Fig. 0744 #3 Shown Mounted**



**Fig. 0744 #3 Shown**

Handle Type	Cam Bar Angle	Strike Type	Dimensions Overall	Standard Pkg.
Knob	135°	Hook	1-1/2" x 3-1/2"	0740001CHR
Knob	180°	Slotted		0740002CHR
Knob	180°	Hook		0740003CHR
Lever	135°	Hook	3-1/2" x 3-1/2"	0743001CHR
Lever	180°	Slotted		0743002CHR
Lever	180°	Hook		0743003CHR
Lever	135°	Hook	1-1/2" x 3-1/2"	0744001CHR
Lever	180°	Slotted		0744002CHR
Lever	180°	Hook		0744003CHR

#### Spare Parts Ordering Information

Slotted Strike: 074000299A Hook Strike: 074000199A



**Slotted Strike "J" Hook Strike**



## Determining the Hand of a Lock or Latch Set

When Standing Outside: If the Door Opens Away From You,  
You Need a Lock or Latch with a Regular Bevel.

If the Door Opens Toward You, You Need a Lock or Latch with a Reverse Bevel.

Refer to the illustrations below when selecting the proper hand configuration of the lock and latch sets on the following pages.

### When Standing Outside



**(A)**

**Lock/Latch Type:**  
**LEFT INWARD**  
Regular Bevel



**(B)**

**Lock/Latch Type:**  
**LEFT OUTWARD**  
Reverse Bevel



**(C)**

**Lock/Latch Type:**  
**RIGHT INWARD**  
Regular Bevel



**(D)**

**Lock/Latch Type:**  
**RIGHT OUTWARD**  
Reverse Bevel

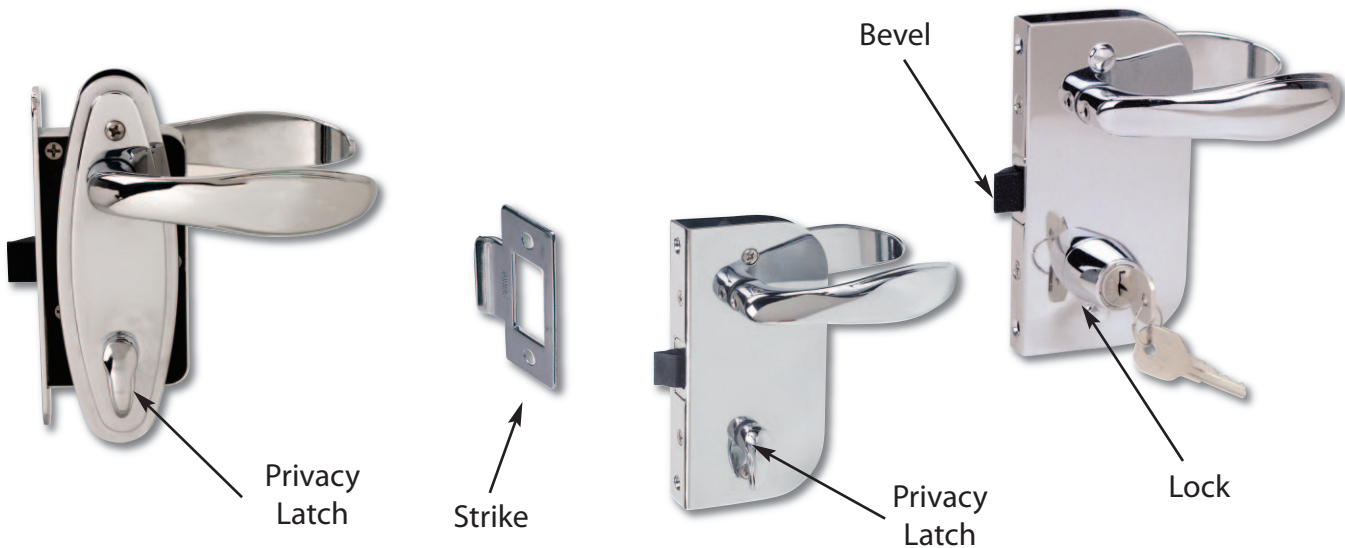

**NOTE:** The privacy latch handle should always be mounted on the door's interior side

## Flush Mount Lock and Latch Sets

### Flush Mount Door Lock and Latch Sets

with privacy latch for interior cabins and head enclosures

Material: Brass and Zinc Alloy Components  
 Finish: Chrome Plated  
 Dimensions: Overall Height: 5-1/4"  
 For Door Thickness: 1/2", 5/8", or 3/4"  
 Features:

- Fig. 0711: Latch set with safety unlock from outside
- Fig. 0731: Lock set with keyed lock from outside and interior turn button lock mechanism from inside



**Fig. 0711  
Flush Latch  
Shown**



**Fig. 0731  
Flush Lock**

Type	Hand of Lock/Latch*	For Door Thickness	Standard Pkg.
Latch	A	1/2"	0711001LIC
Latch	A	5/8"	0711002LIC
Latch	A	3/4"	0711003LIC
Latch	B	1/2"	0711001LOC
Latch	B	5/8"	0711002LOC
Latch	B	3/4"	0711003LOC
Latch	C	1/2"	0711001RIC
Latch	C	5/8"	0711002RIC
Latch	C	3/4"	0711003RIC
Latch	D	1/2"	0711001ROC
Latch	D	5/8"	0711002ROC
Latch	D	3/4"	0711003ROC
Lock	A	1/2"	0731001LIC
Lock	A	5/8"	0731002LIC
Lock	A	3/4"	0731003LIC
Lock	B	1/2"	0731001LOC
Lock	B	5/8"	0731002LOC
Lock	B	3/4"	0731003LOC
Lock	C	1/2"	0731001RIC
Lock	C	5/8"	0731002RIC
Lock	C	3/4"	0731003RIC
Lock	D	1/2"	0731001ROC
Lock	D	5/8"	0731002ROC
Lock	D	3/4"	0731003ROC

**! PROP 65  
WARNING  
(Contains Lead)**

Deck and Cabinet Hardware, Hinges, Locks & Latches

### Flush Mount Door Latch Set

without privacy latch

Material: Brass and Zinc Alloy Components  
 Finish: Chrome Plated  
 Dimensions: Overall Height: 5-1/4"  
 For Door Thickness: 1/2", 5/8", or 3/4"

Type	Hand of Lock/Latch*	For Door Thickness	Standard Pkg.
Latch	A	1/2"	0715001LIC
Latch	A	5/8"	0715002LIC
Latch	A	3/4"	0715003LIC
Latch	B	1/2"	0715001LOC
Latch	B	5/8"	0715002LOC
Latch	B	3/4"	0715003LOC
Latch	C	1/2"	0715001RIC
Latch	C	5/8"	0715002RIC
Latch	C	3/4"	0715003RIC
Latch	D	1/2"	0715001ROC
Latch	D	5/8"	0715002ROC
Latch	D	3/4"	0715003ROC



**Fig. 0715  
Flush Latch  
w/o Privacy  
Latch**

**! PROP 65  
WARNING  
(Contains Lead)**

\* Note: Refer to Page R-162 to determine the proper hand of a lock or latch set.

## Mortise Lock and Latch Sets

### Full Size Mortise Lock and Latch Sets

with privacy lock for interior cabins and head enclosures

- Material: Brass and Zinc Alloy Components  
 Finish: Chrome Plated  
 Dimensions: Overall Height: 5-1/4"  
 For Door Thickness: 1/2" to 3/4"  
 Features:
  - Two escutcheon plates
  - Interchangeable bevels

Fig. 0710: Latch set with safety unlock from outside

Fig. 0730: Lock set with keyed lock from outside and interior turn button lock mechanism from inside



**Fig. 0710**  
Mortise Latch



**Fig. 0730**  
Mortise Lock

Type	Hand of Lock/Latch*	For Door Thickness	Standard Pkg.
Latch	A or D	3/4" to 1"	0710001LIC
Latch	A or D	1" to 1-1/4"	0710002LIC
Latch	A or D	1-1/4" to 1-1/2"	0710003LIC
Latch	B or C	3/4" to 1"	0710001RIC
Latch	B or C	1" to 1-1/4"	0710002RIC
Latch	B or C	1-1/4" to 1-1/2"	0710003RIC
Lock	A or D	3/4"	0730001LIC
Lock	A or D	7/8"	0730002LIC
Lock	A or D	1"	0730003LIC
Lock	A or D	1-1/8"	0730004LIC
Lock	A or D	1-1/4"	0730005LIC
Lock	A or D	1-3/8"	0730006LIC
Lock	A or D	1-1/2"	0730007LIC
Lock	B or C	3/4"	0730001RIC
Lock	B or C	7/8"	0730002RIC
Lock	B or C	1"	0730003RIC
Lock	B or C	1-1/8"	0730004RIC
Lock	B or C	1-1/4"	0730005RIC
Lock	B or C	1-3/8"	0730006RIC
Lock	B or C	1-1/2"	0730007RIC

**PROP 65**  
**WARNING**  
(Contains Lead)

### Full Size Mortise Latch Set

without privacy lock

- Material: Brass and Zinc Alloy Components  
 Finish: Chrome Plated  
 Dimensions: Overall Height: 5-1/4"  
 For Door Thickness: 3/4" to 1-1/2"  
 Features:
  - Two escutcheon plates
  - Interchangeable bevels



**Fig. 0706**  
Mortise Latch  
w/o Privacy Latch

Type	Hand of Latch*	For Door Thickness	Standard Pkg.
Latch	A or D	3/4" to 1"	0706001LIC
Latch	A or D	1" to 1-1/4"	0706002LIC
Latch	A or D	1-1/4" to 1-1/2"	0706003LIC
Latch	B or C	3/4" to 1"	0706001RIC
Latch	B or C	1" to 1-1/4"	0706002RIC
Latch	B or C	1-1/4" to 1-1/2"	0706003RIC

**PROP 65**  
**WARNING**  
(Contains Lead)

\* Note: Refer to Page R•162 to determine the proper hand of a lock or latch set.

## Mortise Lock and Latch Sets

### Compact Mortise Latch Set

with privacy lock for interior cabins and head enclosures

- Material: Brass and Zinc Alloy Components  
 Finish: Chrome Plated  
 Dimensions: Overall Height: 5-1/4"  
 For Door Thickness: 3/4" to 1-1/2"  
 Features:
- Two escutcheon plates
  - Interchangeable bevels
  - Latch set with safety unlock from outside
  - Interior turn button lock mechanism from inside



**Fig. 0712  
Compact  
Mortise Latch**

Type	Hand of Lock/Latch*	For Door Thickness	Standard Pkg.
Latch	A or D	3/4" to 1"	0712001LIC
Latch	A or D	1" to 1-1/4"	0712002LIC
Latch	A or D	1-1/4" to 1-1/2"	0712003LIC
Latch	B or C	3/4" to 1"	0712001RIC
Latch	B or C	1" to 1-1/4"	0712002RIC
Latch	B or C	1-1/4" to 1-1/2"	0712003RIC



### Full Size Surface Mount Lock Set

- Material: Brass and Zinc Alloy Components  
 Finish: Chrome Plated  
 Dimensions: Overall Height: 5-1/4"  
 For Door Thickness : 1-1/16" to 1-3/8"  
 Features:
- Keyed lock from outside
  - Interior turn button lock mechanism from inside



**Fig. 0716  
Surface Mount  
Lock**

Type	Hand of Lock/Latch*	For Door Thickness	Standard Pkg.
Lock	D	1-1/16"	0716001ROC
Lock	D	1-1/8"	0716002ROC
Lock	D	1-3/8"	0716003ROC



For any other door thickness or other "hands", consult factory for availability.

\* Note: Refer to Page R-162 to determine the proper hand of a lock or latch set.

## Lock & Latch Sets

### Rim Latch Sets

- Material: Zinc Alloy  
 Finish: Chrome Plated  
 Dimensions: Case: 2-1/8" x 1-3/4"  
 Escutcheon: 4-3/8" x 1-1/4"  
 For Door Thickness: 5/8" to 1-3/8"  
 Screw Size: #6  
 Features: Sliding lock button  
 Fig. 0928: Regular bevel with box strike  
 Fig. 1028: Reverse bevel with box strike

**Fig. 0928  
Shown  
Assembled**



**Figs. 0928 & 1028**

Bevel Type*	Retail Pkg.	OEM Bulk Pkg.
Regular	0928DP0CHR	0928000CHR
Reverse	1028DP0CHR	1028000CHR



### Rim Latch Sets

- Material: Zinc Alloy  
 Finish: Chrome Plated  
 Dimensions: Case: 2-1/8" x 1-3/4"  
 Escutcheon: 4-3/8" x 1-1/4"  
 For Door Thickness: 5/8" to 1-3/8"  
 Screw Size: #6  
 Features: Sliding lock button  
 Fig. 0930: Regular bevel with flush strike  
 Fig. 1030: Reverse bevel with flush strike

**Fig. 0930  
Shown  
Assembled**



**Figs. 0930 & 1030**

Bevel Type*	Retail Pkg.	OEM Bulk Pkg.
Reverse	0930DP0CHR	0930000CHR
Regular	1030DP0CHR	1030000CHR



\* Note: Refer to Page R-162 to determine the proper bevel of a lock or latch set.

### Spare Parts Ordering Information

**For Figs. 0928 & 1028**

- Box Strike: 0976000CHR
- Regular Bevel with Cam: 0984000CHR
- Knob and Handle Assembly: 0962000CHR
- Reverse Bevel with Cam: 0920DP0CHR

**For Figs. 0930 & 1030**

- Flush Strike: 0912DP0CHR
- Regular Bevel with Cam: 0984000CHR
- Knob and Handle Assembly: 0962000CHR
- Reverse Bevel with Cam: 0920DP0CHR



## Lock & Latch Sets

### Rim Lock Sets

- Material: Zinc Alloy  
 Finish: Chrome Plated  
 Dimensions: Case: 3-7/8" x 2"  
 Escutcheon: 4-3/8" x 1-1/4"  
 For Door Thickness: 5/8" to 1-3/8"  
 Screw Size: #6  
 Features: Locks by turn button from inside  
 or key from outside  
 Fig. 0918: Regular bevel with box strike  
 Fig. 0919: Reverse bevel with flush strike

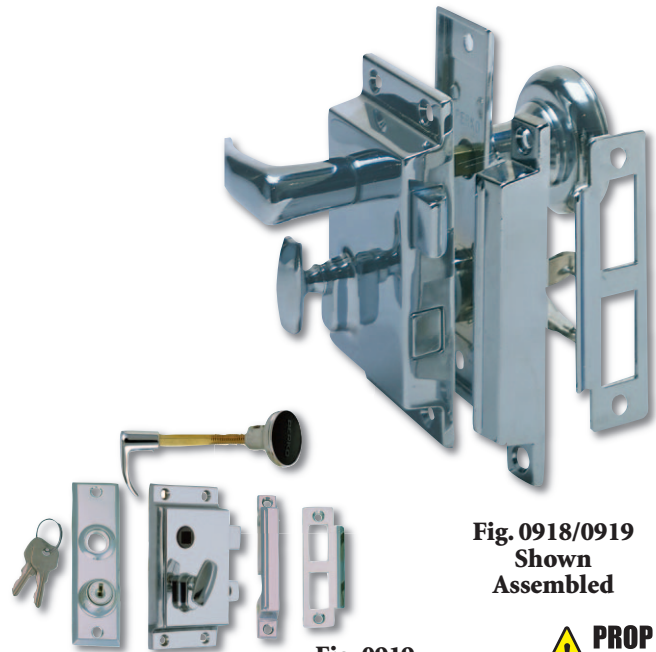

Fig. 0918/0919  
Shown  
Assembled

Fig. 0919

Fig. 0918



Bevel/Strike* Type	Retail Pkg.	OEM Bulk Pkg.
Regular w/Box	0918DP0CHR	0918000CHR
Reverse w/Flush	0919DP0CHR	0919000CHR

### Flush Cup Rim Latch Sets

- Material: Zinc Alloy with Polymer Spacer for Surface Mounting  
 Finish: Chrome Plated with Black Spacer  
 Dimensions: Case: 2-1/8" x 1-3/4"  
 Escutcheon: 2" x 2-1/4"  
 For Door Thickness: 3/4" to 1-1/8"  
 Screw Size: Cup: #8  
 Case: #6  
 Features: Sliding lock button  
 Fig. 1279: Regular bevel with box strike  
 Fig. 1280: Reverse bevel with flush strike

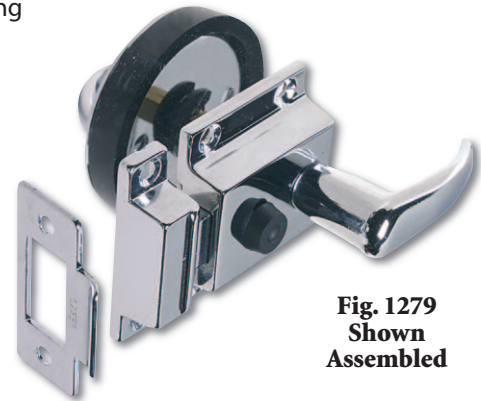

Fig. 1279  
Shown  
Assembled



Fig. 1279

Fig. 1280



Bevel/Strike* Type	Retail Pkg.	OEM Bulk Pkg.
Regular w/Box	1279DP0CHR	1279000CHR
Reverse w/Flush	1280DP0CHR	1280000CHR

\* Note: Refer to Page R-162 to determine the proper bevel of a lock or latch set.

#### Spare Parts Ordering Information

**For Figs. 0918 & 0919**  
 Regular Bevel with Cam: 0984000CHR  
 Reverse Bevel with Cam: 0920DP0CHR  
 Knob and Handle Assembly: 0962000CHR  
 Escutcheon Plate with Keys: 0953000CHR  
 Box Strike: 091800099A  
 Flush Strike: 0913DP0CHR

**For Figs. 1279 & 1280**  
 Regular Bevel with Cam: 0984000CHR  
 Reverse Bevel with Cam: 0920DP0CHR  
 Box Strike: 0976000CHR  
 Flush Strike: 0912DP0CHR

## Lock & Latch Sets

### Mortise Lock Set

- Material: Zinc Alloy  
 Finish: Chrome Plated  
 Dimensions: Case: 2-3/4" x 2"  
 Escutcheon: 4-3/8" x 1-1/4"
- For Door Thickness: 1" to 1-3/8"  
 Screw Size: #6
- Features:
  - Locks by turn button from inside or key from outside.
  - Bevel can be reversed during installation.



**Retail Pkg.** 0927DP0CHR  
**OEM Bulk Pkg.** 0927000CHR



**Fig. 0927**  
Shown  
Assembled



### Mortise Latch Set

- Material: Zinc Alloy  
 Finish: Chrome Plated  
 Dimensions: Case: 2-1/4" x 1-13/16"  
 Escutcheon: 4-3/8" x 1-1/4"
- For Door Thickness: 1" to 1-3/8"  
 Screw Size: #6
- Features:
  - Turn button lock
  - Bevel can be reversed during installation.

**Retail Pkg.** 0960DP0CHR  
**OEM Bulk Pkg.** 0960000CHR



**Fig. 0960**  
Shown  
Assembled

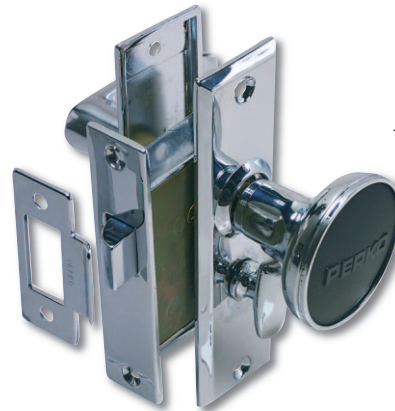

### Tubular Latch Set

- Material: Zinc Alloy  
 Finish: Chrome Plated  
 Dimensions: O.D. Tube: 3/4"  
 Escutcheon: 4-3/8" x 1-1/4"
- For Door Thickness: 1" to 1-3/8"  
 Screw Size: #6
- Features: Sliding lock button

**Retail Pkg.** 0567DP0CHR  
**OEM Bulk Pkg.** 0567000CHR



**Fig. 0567**  
Shown  
Assembled



### Spare Parts Ordering Information

**For Fig. 0927**

Flush Strike: 0913DP0CHR  
 Bevel with Cam: 0920DP0CHR  
 Knob and Handle Assy: 0962000CHR  
 Escutcheon Plate with Keys: 092700099B

**For Fig. 0960**

Flush Strike: 0912DP0CHR  
 Bevel with Cam: 096000099A  
 Knob and Handle Assy: 0962000CHR

**For Fig. 0567**

Flush Strike: 0912DP0CHR  
 Knob and Handle Assy: 0962000CHR

## Hatch Dogs

### Flush Hatch Dog with Rectangular Flange

For Securely "Dogging" (Fastening) Deck Hatches

Material: Bronze with Stainless Steel Lock Nuts

Finish: Chrome Plated

Dimensions: Face Plate: 3-13/16" x 3"

Max Hatch Thickness: Range: 2"

Cam Bar Adjustment: 1-1/4" to 2"

Screw Size: #8

- Features:
- Latch or Locking Versions
  - Flange with visible mounting holes or smooth flange with concealed fasteners
  - Flush strike
  - O-Ring seals for water resistance
  - Does not rattle when "dogged" down

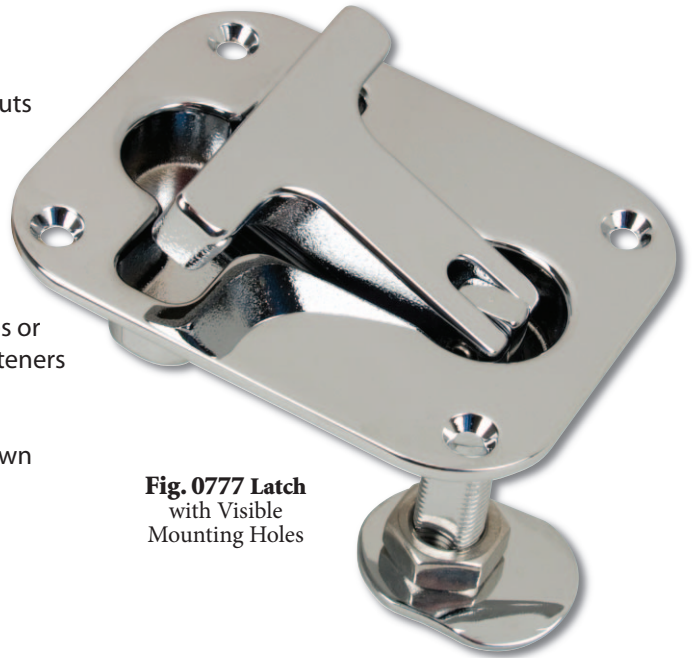

**Fig. 0777 Latch**  
with Visible  
Mounting Holes

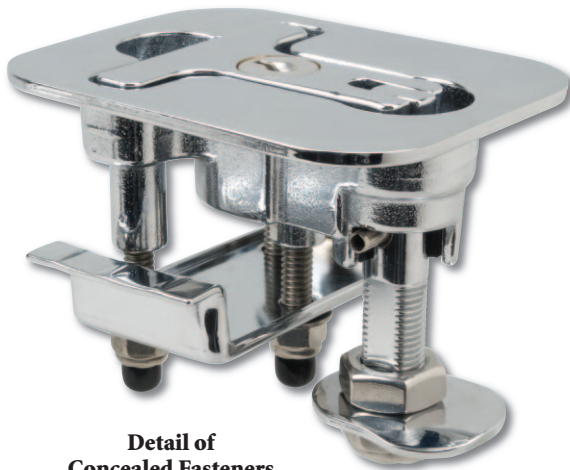

**Detail of  
Concealed Fasteners  
Bottom Plate**



**Fig. 0777FL Lock**  
with Concealed  
Fasteners

**Fig. 0777F Latch**  
with Concealed  
Fasteners

**Fig. 0777L  
Lock with Visible  
Mounting Holes**

Type	Cam Bar Length	Standard. Pkg.* OEM Bulk Pkg. Visible Mount Holes	Standard. Pkg.* OEM Bulk Pkg. Concealed Fasteners
Latch	15/16"	0777000CHR	0777F00CHR
Latch	1-1/2"	0777001CHR	0777F01CHR
Latch	3"	0777002CHR	0777F02CHR
Lock	15/16"	0777L00CHR	0777FL0CHR
Lock	1-1/2"	0777L01CHR	0777FL1CHR
Lock	3"	0777L02CHR	0777FL2CHR

\* Std. Pkg. 1 Pc.



#### Spare Parts Ordering Information

Cam Bar for Size #0: 077700099A  
Cam Bar for Size #1: 077700199A  
Cam Bar for Size #2: 077700299A

### Strike and Cam Bar Options

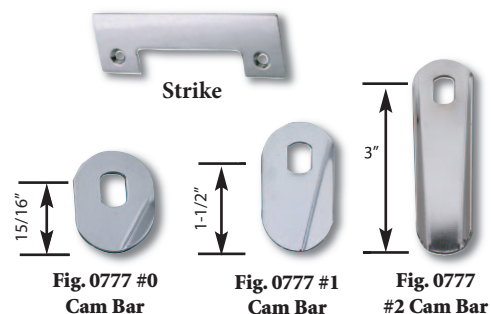

## Cupboard Bolt, Catch, Turn, and Latch

### Cupboard Bolt

Material: Zinc Alloy with Polymer Slide and Knob  
 Finish: Chrome Plated  
 Dimensions: 2-1/8" x 1-1/2"  
 Screw Size: #6

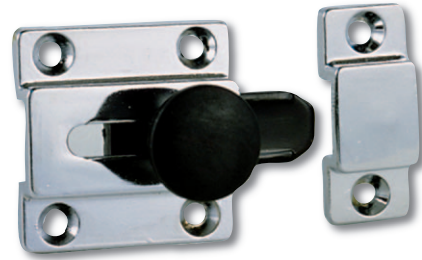

Fig. 1101

Retail Pkg.	OEM Bulk Pkg.
1101DP0CHR	1101000CHR

### Cupboard Catch

Material: Zinc Alloy  
 Finish: Chrome Plated  
 Dimensions: 1-1/2" x 1-7/8"  
 Screw Size: #6  
 Features:
 

- No. 1 Supplied with box strike
- No. 2 Supplied with 3/8" offset box strike
- Spacer included with 1102DP2CHR package to allow for additional (3/16") offset

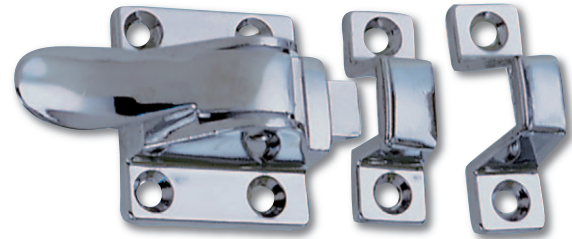

Fig. 1102

Strike Type	Retail Pkg.	OEM Bulk Pkg.
Box	1102DP1CHR	1102001CHR
Offset Box	1102DP2CHR	1102002CHR

3/16" Spacer for use with #2 Offset Box Strike



**PROP 65 WARNING**  
(Contains Lead)

### Cupboard Turn

Material: Zinc Alloy  
 Finish: Chrome Plated  
 Dimensions: 2-1/8" x 2-1/4"  
 Screw Size: #6

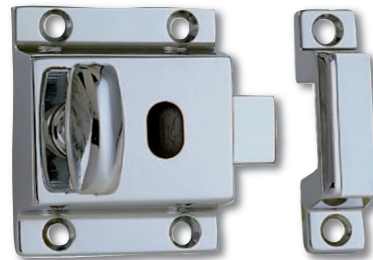

Fig. 0978

Retail Pkg.	Spare Parts Ordering Information	
0978DP0CHR	Strike Plate: 0976000CHR	Bevel with Cam: 0984000CHR

### Latch with Sliding Lock Button

Material: Zinc Alloy  
 Finish: Chrome Plated  
 Dimensions: 2-1/8" x 2-1/4"  
 Screw Size: #6



Fig. 0948

Retail Pkg.	Spare Parts Ordering Information	
0948DP0CHR	Strike Plate: 0976000CHR	Bevel with Cam: 0984000CHR

## Cabinet Lock & Latch, Door Knob, and Elbow Catches

### Cabinet Flush Lock and Latch

Material: Zinc Alloy  
 Finish: Chrome Plated  
 Dimensions: Face Plate: 2-1/4" x 2"  
 Installation: Installs in 1-5/8" diameter hole  
 For Door Thickness: 1/2" to 3/4"  
 Features: Fig. 0921: Lock with 2 keys  
 Fig. 0922: Latch, non-locking



Fig. 0921  
Shown

Type	Retail Pkg.	OEM Bulk Pkg.
Lock	0921DP0CHR	0921000CHR
Latch	0922DP0CHR	0922000CHR

Chrome Cam Bar: 0980A  
 Note: Chrome and Polymer Cam Bars are not interchangeable.



### Door Knob

Material: Brass with Stainless Steel Screw  
 Finish: Chrome Plated  
 Dimensions: O.D. Knob: 1"  
 Max. Panel Thickness: 1-1/8"



Fig. 0925

Retail Pkg.	OEM Bulk Pkg.
0925DP0CHR	0925000CHR



### Elbow Catch

Material: Zinc Alloy with Stainless Steel Spring  
 Finish: Chrome Plated  
 Dimensions: 1-1/8" x 9/16"  
 Screw Size: #6



Fig. 1056

Retail Pkg.	OEM Bulk Pkg.
1056DP0CHR	1056000CHR

### Elbow Catch

Material: Polymer with Integral Spring  
 Finish: Black  
 Dimensions: 1-3/16" x 5/8"  
 Screw Size: #6



Fig. 1021

Retail Pkg.*	OEM Bulk Pkg.
1021DP0BLK	1021000BLK

\*Sold in Pairs

## Ring Catch and Pulls

### Flush Ring Catch

Material: Zinc Alloy with Phosphor Bronze Spring  
 Finish: Chrome Plated  
 Dimensions: 2-1/4" x 1-3/8"  
 Screw Size: #6

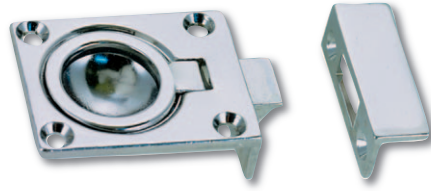

Fig. 1051

Retail Pkg.	OEM Bulk Pkg.
1051DP0CHR	1051000CHR

### Flush Pull

Material: Zinc Alloy and Stainless Steel  
 Finish: Chrome Plated  
 Dimensions: Face Plate: 3-11/16" x 1-11/16"  
 Depth: 7/16"  
 Screw Size: #6



Fig. 1110

Retail Pkg.	OEM Bulk Pkg.
1110DP0CHR	1110000CHR

### Flush Pull

Material: Polymer  
 Finish: Black, White, or Ivory  
 Dimensions: Face Plate: 2-1/4" x 2-1/4"  
 Depth: 15/16"  
 Installation: Installs in a 1-3/4" Diameter Hole  
 Screw Size: #6

**NEW  
COLOR**  
Ivory

Fig. 1016  
Ivory

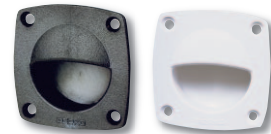

Black

White

Color	Retail Pkg.	OEM Bulk Pkg.
Black	1016DP0BLK	1016000BLK
White	1016DP0WHT	1016000WHT
Ivory	1016DP0IVR	1016000IVR

### Pull

Material: Zinc Alloy  
 Finish: Chrome Plated  
 Dimensions: Width Overall: 3-7/16"  
 Width Inside: 2-5/16"  
 Screw Size: #6



Fig. 0958

Retail Pkg.
0958DP0CHR

## Flush Pulls

### Flush Ring Pull

Material: Zinc Alloy  
 Finish: Chrome Plated  
 Dimensions: 1-3/4" x 1-3/8"  
 Screw Size: #6

Retail Pkg.	OEM Bulk Pkg.
0841DP0CHR	0841000CHR



Fig. 0841

### Flush Ring Pull

Material: Zinc Alloy  
 Finish: Chrome Plated  
 Dimensions: No. 1 O.D. Face Plate: 1-5/8"  
 No. 2 O.D. Face Plate: 2"  
 Screw Size: #6

Retail Pkg.	OEM Bulk Pkg.
1232DP1CHR	1232001CHR
1232DP2CHR	1232002CHR



Fig. 1232

### Flush Ring Pull

Material: Bronze  
 Finish: Chrome Plated  
 Dimensions: 2-9/16" x 2"  
 Screw Size: #8

Retail Pkg.	OEM Bulk Pkg.
1103DP0CHR	1103000CHR



Fig. 1103

**PROP 65**  
**WARNING**  
 (Contains Lead)

### Flush Lifting Pull

Material: Bronze  
 Finish: Chrome Plated  
 Dimensions: 2-5/8" x 2"  
 Screw Size: #8

Retail Pkg.	OEM Bulk Pkg.
0575DP0CHR	0575000CHR



Fig. 0575

**PROP 65**  
**WARNING**  
 (Contains Lead)

## Pull and Lifting Handles

### Flush Lifting Pull

- Material: Zinc Alloy and Polymer  
 Finish: Chrome Plated Body and Black Finishing Flange  
 Dimensions: Flange: 3/4" x 3-1/4"  
 Screw Size: #8  
 Features:
  - Spring loaded
  - Can be mounted horizontally or vertically



Fig. 1221

Retail Pkg.	OEM Bulk Pkg.
1221DP0CHR	1221000CHR

### Flush Lifting Handle

- Material: Bronze  
 Finish: Chrome Plated  
 Screw Size: #8  
 Features:
  - Size No. 1 has mounting holes Inset on top
  - Size No. 2 has all mounting holes at corners



Fig. 0776 Size #1



Fig. 0776 Size #2

Dimensions Face Plate	Dimensions Inside Handle	Dealer Pkg.	OEM Bulk Pkg.
3" x 2-1/4"	1-7/8" x 1"	0776DP1CHR	0776001CHR
3-3/4" x 2-3/4"	2-3/16" x 1-3/16"	0776DP2CHR	0776002CHR



### Flush Lifting Handle

- Material: Zinc Alloy  
 Finish: Chrome Plated  
 Dimensions: Face Plate: 3" x 2-1/4"  
 Inside Handle: 1-7/8" x 1"  
 Screw Size: #8



Fig. 1220

Retail Pkg.	OEM Bulk Pkg.
1220DP0CHR	1220000CHR



## Door & Window Stop, Handle, and Angled Fastener

### Sliding Window Stops

Material: Zinc Alloy and Polymer  
 Finish: Chrome Plated with Black Cover on Stopping Plate  
 Dimensions: Mounting Plate: 1-7/8" x 3/4"  
 Stopping Plate Length: 1-1/2"  
 Screw Size: #8

Retail Pkg.	OEM Bulk Pkg.
0935DP0CHR	0935000CHR

Fig. 0935



**PROP 65 WARNING**  
(Contains DINP)

### Sliding Door Stop

Material: Heavy Gauge Extruded Brass and Polymer  
 Finish: Chrome Plated with Black Cover on Stopping Plate  
 Dimensions: Mounting Plate: 1-1/2" x 3/4"  
 Stopping Plate Length: 2"  
 Screw Size: #10

Retail Pkg.	OEM Bulk Pkg.
0966DP0CHR	0966000CHR

Fig. 0966



**PROP 65 WARNING**  
(Contains Lead & DINP)

### Sliding Window Handle

Material: Stainless Steel  
 Finish: Plain  
 Dimensions: Length Overall: 3"  
 For Glass Thickness: 1/4"

Retail Pkg.
0954DP0STS

Fig. 0954



### Removable Angled Fastener

Material: Brass and Polymer Knob with Stainless Steel Stud  
 Finish: Chrome Plated and Black  
 Dimensions: Length Angle: 1-3/8"  
 Width Angle: 1"  
 Screw Size: #8  
 Features: Ideal for table legs

Retail Pkg.	OEM Bulk Pkg.
0719DP0CHR	0719000CHR

Fig. 0719



#### Spare Parts Ordering Information

Knob: 071900099A  
 Single Bracket: 071900099B  
 Flat Plate: 071900099C

**PROP 65 WARNING**  
(Contains Lead)

## Table Brackets and Utility Hooks

### Table Brackets - For Removable Tables

Supplied in Sets of Two Brackets and Two Wall Plates

Material: Brass  
 Finish: Chrome Plated  
 Dimensions: Angle Bracket: 2-3/4" x 1-11/16"  
 Wall Plate: 3-3/8" x 2"  
 Screw Size: #10



Fig. 0148

Retail Pkg.	OEM Bulk Pkg.
0148DP0CHR	0148000CHR

Sold in Sets

**Spare Parts Ordering Information**

Pair of Angle Brackets: 014800099A  
 Pair of Wall Plates: 014800099B



### Utility Hook

Material: Zinc Alloy  
 Finish: Chrome Plated  
 Dimensions: Overall Width: 3", Projection: 3/4"  
 Base Width: 1"  
 Screw Size: #6



Fig. 1106

Retail Pkg.	OEM Bulk Pkg.
1106DP0CHR	1106000CHR

### Utility Hook

Material: Zinc Alloy  
 Finish: Chrome Plated  
 Screw Size: #6



Fig. 0975

Projection	Base Width	Retail Pkg.	OEM Bulk Pkg.
2"	1-1/8"	0975DP1CHR	0975001CHR
3"	1-1/4"	0975DP2CHR	0975002CHR

### Utility Hook

Material: Zinc Alloy  
 Finish: Chrome Plated  
 Dimensions: Projection: 1-3/8"  
 Base Width: 1-1/8"  
 Screw Size: #6



Fig. 0610

Retail Pkg.	OEM Bulk Pkg.
0610DP0CHR	0610000CHR

## Utility Hook, Boat Cover Sockets, and Fasteners

### Utility or Lashing Hook

Material: Zinc Alloy  
 Finish: Chrome Plated  
 Dimensions: Length: 15/16", Width: 1/2"  
 Inside Hook: 1/4"  
 Screw Size: #6

Retail Pkg.*	OEM Bulk Pkg.
1249DP0CHR	1249000CHR

\*Sold 5 pcs. per card



Fig. 1249

### Boat Cover Sockets

Will Accommodate 3/8" Wood or Polymer Battens Up To 1-3/4" Long

Material: Zinc Alloy  
 Finish: Chrome Plated  
 Dimensions: Length: 3-1/4", Width: 5/8"  
 Opening: 1-7/8" x 7/16"  
 Screw Size: #6

Retail Pkg.
0578DP0CHR

Sold in Pairs



Fig. 0578

### "Durable Type" Fasteners

Material: Figs. 0896, 0898, 0901 & 0907: Brass  
 Fig. 0869: Stainless Steel, 5/8" Self Tapping Screw  
 Finish: Figs. 0896, 0898, 0901 & 0907: Nickel Plated  
 Use:
 

- For Canvas to Surface, Use Figs. 0869, 0896 and 0898
- For Canvas to Canvas, Use Figs. 0896, 0898, 0901 & 0907

Description	Standard Pkg.
Stud	0869000STS
Stud	0901000NKL
Socket	0898000NKL
Button	0896000NKL
Eyelet	0907000NKL

Sold in boxes of 100 pcs.



Stud  
Fig. 0869



Button  
Fig. 0896



Socket  
Fig. 0898



Stud  
Fig. 0901



Eyelet  
Fig. 0907



### Curtain Fasteners

Material: Brass  
 Finish: Nickel Plated



Washer  
Fig. 0997



Eyelet  
Fig. 0996



Flanged Stud  
Fig. 0994



Description	Standard Pkg.
Flanged Stud	0994000NKL
Eyelet	0996000NKL
Washer	0997000NKL

Sold in boxes of 100 pcs.

## Fishing Rod Holders

### Fishing Rod Holder Vertical Flush Mount

- Material: Bronze Flange with Stainless Steel Tube and Hard Polymer Liner  
 Finish: Chrome Plated Flange and Black Liner  
 Dimensions: Tube: 2" O.D. , 1-5/8" I.D.  
 Flange O.D.: 3-1/2"  
 Bolt Size: #10  
 Features:
  - Includes flange gasket with integral flip-up cap
  - D01 & DPD have integral drain bib for 5/8" I.D. flexible hose



Fig. 0447

Drain Bib	Length Under Flange	Retail Pkg.	OEM Bulk Pkg.
No	9"	0447DP1CHR	0447001CHR
Yes	10-1/2"	0447DPDCHR	0447D01CHR



Figs. 0447D01 & DPD  
with Drain Bib



### Fishing Rod Holder Angled Flush Mount (Approximate 65°)

- Material: Bronze Flange with Brass Tube and Soft Polymer Liner  
 Finish: Chrome Plated with Black Liner  
 Bolt Size: 1/4"  
 Features:
  - Size No. 1: Includes soft liner and flange gasket with integral flip-up cap
  - Size No. 2: Includes soft liner with lip only
  - D01 & DPD have integral drain bib for 5/8" I.D. flexible hose



Fig. 0448D01

Drain Bib	I.D. Tube	O.D. Tube	Length Under Flange	Dimensions Flange	Retail Pkg.	OEM Bulk Pkg.
No	1-5/8"	2"	8"	4-1/4" x 3-1/2"	0448DP1CHR	0448001CHR
Yes	1-5/8"	2"	9-1/2"	4-1/4" x 3-1/2"	0448DPDCHR	0448D01CHR
No	1-7/8"	2-1/4"	12"	4-7/8" x 4"	0448DP2CHR	-----



Figs. 0448D01 & DPD  
with Drain Bib



For spare parts for all rod holders on this page, see page 181.

## Fishing Rod Holders

### Fishing Rod Holder

#### Angled Flush Mount (Approximate 65°)

- Material: Zinc Alloy Flange, Anodized Aluminum Tube, and Soft Polymer Liner  
 Finish: Chrome Plated with Black Liner  
 Dimensions: Tube: 2" O.D. , 1-5/8" I.D.  
 Flange: 4-1/4" x 3-1/2"  
 Bolt Size: 1/4"  
 Features:
  - Includes flange gasket with integral flip-up cap
  - D01 & DPD have integral drain bib for 5/8" I.D. flexible hose



Fig. 1205

Drain Bib	Length Under Flange	Retail Pkg.	OEM Bulk Pkg.
No	8"	1205DP0CHR	1205000CHR
Yes	9-1/2"	1205DPDCHR	1205D01CHR



Figs. 1205D01 & DPD with Drain Bib



### Fishing Rod Holder

#### Angled Flush Mount (Approximate 65°)

- Material: Stainless Steel Flange and Tube with Soft Polymer Liner  
 Finish: Polished with Black Liner  
 Dimensions: Tube: 2" O.D. , 1-5/8" I.D.  
 Flange: 4-1/8" x 3-3/8"  
 Bolt Size: #10  
 Features:
  - Includes flange gasket w/integral flip-up cap
  - D01 & DPD have integral drain bib for 5/8" I.D. flexible hose



Fig. 0452

Drain Bib	Length Under Flange	Retail Pkg.	OEM Bulk Pkg.
No	8-1/4"	0452DP0STS	0452000STS
Yes	9-3/4"	0452DPDSTS	0452D01STS



Figs. 0452D01 & DPD with Drain Bib



For spare parts for all rod holders on this page, see page 181.

## Fishing Rod Holders

### Clamp-On Fishing Rod Holder

Clamp-On Feature Eliminates Drilling Rail and Simplifies Relocation

- Material: Zinc Alloy Clamp, Stainless Steel Tube, and Hard Polymer Liner
- Finish: Chrome Plated Clamp, Polished Tube with Black Liner
- Dimensions: Tube: 2" O.D., 1-5/8" I.D.  
Length: 9"
- For Rail Sizes: 3/4" to 1-1/4"
- Features:
- Mounts on vertical or horizontal rails
  - DP0 Fits Rails 3/4" to 1" in diameter
    - Adjustable as supplied for 7/8" to 1" rails
    - Adaptable to 3/4" rails by reducing the mounting bolt length
  - DP2 fits 1-1/4" diameter rails



**Fig. 1215DP0**  
for 3/4" to 1"  
Dia. Rails



**Fig. 1215DP2**  
for 1-1/4"  
Dia. Rails

For Rail Size	Retail Pkg.
3/4" to 1"	1215DP0CHR
1-1/4"	1215DP2CHR

#### Spare Parts Ordering Information

Face Plate with Bolts for 1215DP0CHR: 1215DP099A  
Clamp Bracket with Bolts for 1215DP2CHR: 121500299A  
Intermediate Plate for 1215DP0CHR: 121500099B  
Intermediate Plate for 1215DP2CHR: 121500299B

### Heavy Duty Side Mount Fishing Rod Holder

#### Fig. 0404

- Material: Brass and Bronze with Hard Polymer Liner
- Finish: Chrome Plated with Black Liner
- Dimensions: Tube: 2" O.D., 1-5/8" I.D.  
Length: 9"
- Bolt Size: 1/4"

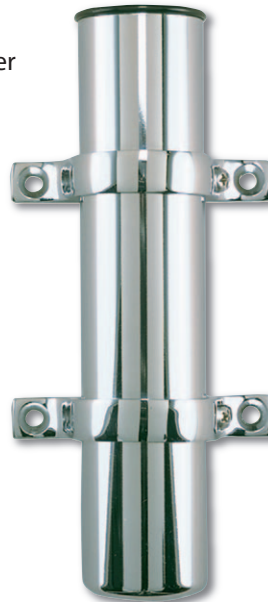

**Fig. 0404**



**Fig. 1104**

### Side Mount Fishing Rod Holder

#### Fig. 1104

- Material: Polymer with Brass Mounting Brackets
- Finish: Chrome Plated and Black
- Dimensions: Tube: 2" O.D., 1-5/8" I.D.  
Length: 9"
- Screw Size: #8 R.H.

Width Bracket	Retail Pkg.
4-3/16"	0404DP1CHR
3-1/4"	1104DP0BLK

#### Spare Parts Ordering Information

Fig. 0404 Spare Bracket: 040400199A  
Fig. 1104 Spare Bracket: 1107000CHR (Sold in Pairs)



**NOTE:** The use of a safety line attached to the rod and reel is recommended, particularly when running or fishing with heavy duty rods and reels.

## Fishing Rod Holder Spare Parts

### Cap and Gasket Kits for Fishing Rod Holders

#### Replacement or Upgrade for Older Holders

Material: Soft Polymer Lip and Flange Gasket, with Integral Flip-up Cap  
 Finish: Black



Fig. 0480

To Fit Catalog Number	Retail Pkg.
0448DP1CHR	0480DP0BLK
0447DP1CHR	0484DP0BLK*
0452DP0STS	0481DP0BLK
1205DP0CHR	0480DP0BLK

\* 0484DP0BLK has cap and gasket only.



### Liners, Lips, and Tubes for Fishing Rod Holders

#### Replacement or Upgrade for Older Holders

Material: Soft Polymer Lip and Flange Gasket, with Integral Flip-up Cap  
 Finish: Black



Fig. 0482

Fig. 0483

Lip & Liner Cat. No.	Lip Only Cat. No.	Fits Rod Holders Listed Below						
		0448#1	0448D	0448#2	0452	1205	0449	0404#2
0482DP1BLK	0482DP199A	X	X		X	X		
0482DP2BLK	0482DP299A			X				
0483DP1BLK	0483DP199A						X	
0483DP2BLK	0483DP299A							X

I.D.	Retail Pkg. For Angled Flush Mt. Complete	Retail Pkg. For All Others Complete	Retail Pkg. Spare Lip Only For Fig. 0482	Retail Pkg. Spare Lip Only For Fig. 0483
1-5/8"	0482DP1BLK	0483DP1BLK	0482DP199A	0483DP199A
1-7/8"	0482DP2BLK	0483DP2BLK	0482DP299A	0483DP299A



## Numeric Index

Fig. No.	Page No.
0024	66, 67 & 68
0030	62, 108 & 125
0042	86
0063	99
0065	97
0066	97
0067	61 & 69
0068	31
0069	61
0070	61
0071	61
0072	61
0074	60
0075	105
0076	99
0093	27
0095	27
0086	97
0106	24
0107	13 & 18
0108	24
0109	24
0110	24
0111	24
0113	73
0114	11 & 16
0119	133
0120	148
0123	73
0124	106
0125	51
0127	73
0134	30
0135	12, 18, 31 & 33
0136	12
0137	63
0139	17
0140	63
0142	105
0144	73
0145	63
0148	176
0149	149
0150	72 & 73
0152	149
0153	73
0155	140
0158	73
0159	72 & 73
0162	74
0163	85

Fig. No.	Page No.
0164	85
0166	73
0170 SWB	36
0170 LED	22
0170 BMD	31
0170	23
0171	73
0172	73
0179	73
0196	85
0197	148
0200	26 & 27
0201	60
0210	25
0212	149
0217	67
0222	27
0223	67
0224	27
0227	12 & 60
0228	17 & 60
0229	60
0232	60
0238	60
0239	60
0240	60
0241	60
0247	60
0248	60
0249	30
0250	68
0252	11
0253	16
0254	20
0256	24
0257	66, 67 & 68
0258	149
0259	24 & 60
0260	60
0261	60
0264	21
0266	106
0268	60
0269	24
0271	148
0272	148
0273	60
0274	20
0276	68
0277	60
0278	60

Fig. No.	Page No.
0281	60
0283	60
0284	60
0285	105
0295	60
0296	60
0297	60
0298	60
0300	66
0301	102
0305	71
0313	71
0314	71
0315	126
0322	101
0323	103
0325	137
0326	105
0327	103
0328	102
0329	68
0330	127
0331	100
0333	103
0334	128
0335	128
0337	61 & 69
0338	61
0339	126
0340	69
0343	103
0345	104
0348	101
0349	74
0350	100
0351	135
0357	134
0361	104
0363	106
0365	105
0370	106
0374	61
0375	61
0377	104
0380	134
0390	55
0391	55, 58 & 59
0392	55
0393	55
0394	54 & 55
0404	180

Fig. No.	Page No.
0420	72 & 73
0424	86
0443	90 & 91
0447	178
0448	178
0452	179
0455	42
0456	87
0457	87
0461	74
0462	83
0465	73
0477	49
0480	181
0481	181
0482	181
0483	181
0484	181
0492	137
0493	92 & 93
0499	129
0500	94 & 95
0501	135
0502	140
0503	112
0504	129
0506	111
0507	119 & 125
0509	112
0510	126
0513	121
0514	68
0515	112
0518	111
0520	119 & 125
0524	121 & 125
0525	122
0526	129
0528	121
0530	131
0537	122
0539	129
0540	113 & 125
0540 RNG	122
0541	113
0542	118 & 125
0543	118
0545	130
0551	114
0552	115 & 125
0554	153





# Numeric Index

Fig. No.	Page No.	Fig. No.	Page No.	Fig. No.	Page No.	Fig. No.	Page No.
0555	68	0710	164	0904	13	0999	147
0556	113 & 125	0711	163	0907	177	1002	145
0557	113	0712	165	0912	166, 167 & 168	1004	145
0559	153	0714	106	0913	167 & 168	1008	143
0561	111	0715	163	0915	18	1016	172
0562	142	0716	165	0918	167	1017	137
0563	116 & 125	0719	175	0919	167	1021	171
0564	116	0721	97	0920	166, 167 & 168	1028	166
0566	131	0722	97	0921	171	1030	166
0567	168	0730	164	0922	171	1031	158
0568	114	0731	163	0925	171	1032	158
0569	115	0740	161	0927	168	1033	63
0570	111	0742	106	0928	166	1044	65
0571	111	0743	161	0930	166	1045	58 & 59
0572	130	0744	161	0931	158	1046	58 & 59
0574	152	0752	134	0932	158	1047	58 & 59
0575	173	0753	68	0935	175	1048	58 & 59
0576	118 & 125	0757	135	0939	33	1049	57
0577	118	0759	142	0941	146	1050	135
0578	177	0762	141	0942	147	1051	172
0579	118	0769	140	0945	32	1052	41
0580	114	0771	143	0946	33	1053	151
0581	114	0775	136	0947	150	1054	41
0582	115 & 125	0776	174	0948	170	1056	171
0583	115	0777	169	0949	145	1057	135
0590	116 & 125	0780	124	0951	146	1058	41
0591	116	0782	124	0952	145	1059	58 & 59
0592	110	0786	85	0953	167	1060	58 & 59
0593	88 & 89	0790	124	0954	175	1065	152
0597	110	0795	117	0955	21	1071	159
0598	110	0805	98	0956	151	1072	159
0599	120	0808	146	0957	149	1074	65
0602	19	0826	123	0958	172	1075	153
0606	63	0828	139	0959	144 & 151	1081	159
0607	63	0829	139	0960	168	1082	159
0608	134	0830	139	0962	166, 167 & 168	1085	155
0610	176	0831	139	0963	18	1086	154
0615	11	0832	139	0964	31	1089	158
0616	16	0833	139	0965	33	1091	156 & 157
0617	19	0834	98	0966	175	1092	156 & 157
0630	109	0835	98	0972	12	1093	157
0632	109	0841	173	0975	176	1097	160
0635	108	0869	177	0976	166, 167 & 170	1101	170
0660	124	0870	126	0978	170	1102	170
0662	124	0883	71	0984	166, 167 & 170	1103	173
0675	160	0884	71	0987	147	1104	180
0697	140	0885	71	0988	147	1105	30
0701	66	0887	71	0994	177	1106	176
0706	164	0896	177	0996	177	1107	180
0707	127	0898	177	0997	177	1108	143
0709	97	0901	177	0998	144	1110	172

## Numeric Index

Numerical & Alphabetic Indexes

Fig. No.	Cat. Type	Page No.
1112		143
1113		143
1116		141
1117		141
1119		30
1123		51, 58 & 59
1124		51, 58 & 59
1125		51
1127		30
1128		30
1129		30
1130		30
1134		36
1137		36
1138		36
1144		41
1146		64
1149		64
1155		138
1156		64
1158		38 & 51
1177		152
1181		38
1183		38
1184		38
1185		138
1186		138
1187		138
1188		130
1189		86
1190		86
1192		62
1194		144
1196		38
1197		38
1198		144
1199		151
1201		38
1205		179
1209		49
1211		15
1212		15
1213		147
1214		147
1215		180
1216		152
1217		152
1218		13
1220		174
1221		174
1223		133

Fig. No.	Cat. Type	Page No.
1226		142
1227		138
1230		133
1231		136
1232		173
1234		136
1236		39
1238		127
1241		123
1242		142
1244		150
1247		123
1248		123
1249		177
1252		131
1253		66
1254		65
1256		142
1261		142
1262		138
1263		67
1264		21
1267		138
1269		119
1270		119 & 125
1271		127
1279		167
1280		167
1281		39
1283		39
1284		39
1287		151
1290		141
1291		141
1293		146
1299		137
1301		36
1305		132
1306		132
1309		137
1310		12
1311		50
1312		126
1313		120
1316		132
1318		117
1319		117
1323		68
1324		122
1325		135
1326		132

Fig. No.	Cat. Type	Page No.
1330		49
1331		32
1332		32
1336		136
1342		42
1343		45
1345		42
1346		136
1347		44
1348		52
1349		52
1353		150
1354		150
1356		67
1361		50
1377		29
1378		29
1379		29
1380		29
1381		28
1399		120
1400		47
1401		57
1403		47
1404		47
1421		15
1422		15
1440	LED	45
1440		48
1441		57
1442		44
1443		57
1445	LED	45
1445		48
1447		44
1450		53
1451		52
1452		53
1454		53
1455		53
1456		53
1459		53
1460		46
1461		57
1465		46
1470		46
1601		17
1602		17
1604		35
1607		35
1608		34

Fig. No.	Cat. Type	Page No.
1609		34
1611		50
1612		14
1613		120
1614		57
1617		14
1619		57
1622	LED	45
1622		48
1624		44
1625		51
1627		40
1628		40
1634		35
1636		34
1637		35
1638		35
1639		34
1642		34
1656		46
1680		37 & 51
1681		37
1683		37
1684		37
1696		37
1697		37
1900		70
8501		83
8502		83
8503		83
8504		83
8511		82
8512		82
8521		80 & 81
8603		84
9304		70
9601		83
9602		83
9603		83
9604		83
9611		82
9612		82
9621		80 & 81
9703		84
9854		70



# Alphabetic Index

C CONTINUED	PAGE
<b>A</b>	
Adapter - Pipe to Hose .....	99
Adjusters - Hatch .....	141
Windshield .....	141
Air/Fuel Separator.....	Emissions Cat. 315-E
Alpha Series Lights.....	36 and 47
All-Round Lights .....	24-30 and 34-57
Anchor Lights .....	24-30 and 34-57
Arch Tower Mount Lights.....	34 and 35
Axe Bracket .....	137
<b>B</b>	
Ball Whistle.....	74
Bass Boat Lights.....	14, 15 and 17
Bases, Pole Light.....	40, 41 and 57-59
Battery - Switches.....	75 to 84
Bulkhead Mount .....	81
Cable Spacer .....	83
Compact .....	82
Cup Mount.....	80
Heavy Duty .....	84
Medium Duty.....	83
Panel Mount.....	81
Bells, Fog.....	72 and 73
Bi-Color Lights.....	11-15 and 23
Bitts .....	134
Boarding Steps.....	135
Bolts - Barrel .....	150
Cupboard .....	170
Bow - Lights.....	11 to 30
Anchor Lights.....	22-31 and 34-53
Combination Lights.....	11-15, 23, 31, .....37-39 and 51
Brackets - Axe .....	137
Table .....	175 and 176

B CONTINUED	PAGE
Breakdown Lights .....	24 to 30
Bulbs, Electric.....	61 and 69
Butt Hinges.....	145 and 146
Buttons - Door .....	152
Push .....	66
<b>C</b>	
Cabin Door Hooks .....	151
Cabinet Hinges.....	145 to 149
Cable - Outlet.....	86
Spacer .....	83
Straps.....	85
Caps - Gas Tank.....	117, 124 and 125
EPA .....	124
Non-Vented .....	125
Pressure Relief.....	124
Vented.....	125
Water .....	125
Waste .....	125
Carbon Canisters .....	107 and .....Emissions Cat. 315-E
CARB Certified .....	124 and .....Emissions Cat. 315-E
Catches, Door .....	153
Certification of Lights.....	10
Chocks.....	133
Choosing a Pole Light .....	43
Clam Shell Ventilators.....	126
Clamps - Hatch Hold-Down .....	143 and 144
Spring .....	140
Rope.....	142
Security.....	143
Clear Back Utility Light .....	64
Cleats .....	130 to 132
Clips - Line Support .....	85
Coat & Hat Hooks .....	176

## Alphabetic Index

C CONTINUED	PAGE
Cockpit Scupper .....	103 to 105
Color Coded Deck Plates & Fills.....	114, 115 117, .....124 & 125
Collar Set .....	62
Combination -	
Bow & Anchor Lights .....	11-15, 22-30 and 34-57
Masthead/White All-Round .....	22-32 and 34-55
Side Lights.....	16-26, 29 and 30
Compression Lock.....	154
Connections -	
Electric .....	85 and 86
Thru Hull .....	100 to 106
Watertight, Deck.....	86
Connectors, Electric.....	85 and 86
Connectors, Garden Hose.....	129
Continuous Hinge.....	149
Courtesy Lights .....	63 to 65
Cowl Ventilators .....	126
Cupboard -	
Bolts .....	172
Catches.....	150-153 & 170-172
Turns.....	170
Curtain Fasteners .....	177
<b>D</b>	
Deck -	
Connection, Watertight.....	86
Diesel Fills.....	113 to 121
Fills .....	113 to 121
Gas Fills.....	113 to 121
Lights.....	34 to 42
Pipes, for Rope & Chain .....	135
Plates.....	121 & 129
Water Fills .....	113 to 121
Waste Fills .....	113 to 131
Deck Plate Keys .....	123
Delta Series Pole Lights.....	46 and 52
Dock Line Springs .....	142
Dome Lights .....	66 to 68
Door -	
Buttons .....	152

D CONTINUED	PAGE
Catches .....	153, 170 to 172
Fasteners.....	143,144, 150 to 153
Hinges .....	145 to 149
Holders.....	152 and 175
Hooks .....	151
Stops.....	152 and 175
Dorade Ventilator .....	126
Drain Plugs .....	106
Drawer Knobs.....	171
<b>E</b>	
Elbow Catches.....	171
Electric -	
Bulbs.....	61 and 69
Cabin Fixtures .....	63 to 68
Connections .....	85 and 86
Lamps.....	63 to 68
Switches .....	66
EPA Certified Components	
.....	124 & Emissions Cat. 315-E
European Representative .....	5
Eyes Straps .....	142
<b>F</b>	
Fasteners -	
Curtain .....	177
Door .....	143, 144, 150-153
Hatch.....	140,141 and 175
Table Leg.....	176
Fender-	
Hooks .....	137
Locks.....	137
Filler, Tank.....	113 to 122
Fill Limit Valves.....	Emissions Cat 315-E
Filters, Water .....	87 to 93
Fishing Rod Holders .....	178 to 181
Fittings -	
For Rails .....	134
Waste .....	113 to 131
Fixtures, Light -	
Bulkhead, Electric.....	63 to 68
Electric Cabin .....	66 to 68



# Alphabetic Index

F CONTINUED	PAGE
Flip-Top Cap for Deck Fills.....	117
Flush Pro.....	87
Flush -	
Hatch Lifting Handles .....	174
Hatch Lifting Rings.....	173
Locks & Latches .....	154 to 171
Pulls.....	156, 172 to 174
Ring Catch.....	172
Fog Horn.....	74
Fold Down Mount Lights .....	34 to 41, 54
Fuel Caps .....	124 and 125
Fuel Tank Filler.....	113 to 122
Fuel Tank Vent .....	109 to 112
Fuel Demand Valve .....	Emissions Cat. 315-E
Fuse Holder.....	85
<b>G</b>	
Garboard Drain Plugs.....	106
Gas Fills .....	113 to 121
Gas Tank Vents .....	109 to 102
Gasket Kit.....	181
Glare Shield.....	62
Grab Rail Posts .....	134
Guides, Tiller Rope.....	142
<b>H</b>	
Halyard Mount Lights.....	27
Handles -	
Daysailer.....	136
Flush Lifting.....	169 and 174
Sliding Window.....	175
Various .....	136
Hasps.....	144
Hatch -	
Adjusters.....	141
Dog .....	169
Fasteners.....	140
Hinges .....	145 to 149
Hold-Down Clamps.....	143
Lifting Handles .....	169 and 174
Lifting Rings.....	173

H CONTINUED	PAGE
Trim .....	149
Support Braces.....	141
Hawse Hole Plate.....	134
Heavy Duty Pole Lights .....	154 and 155
Hinges -	
Butt.....	145 and 146
Cabinet.....	145 to 149
Continuous .....	149
Cuddy Door .....	145 to 149
Hatch .....	145 to 149
Hatch Support.....	141
Non-Mortised .....	149
Piano.....	149
Pull Apart .....	149
Semi-Concealed .....	148
Shortside .....	147
Strap .....	148
“T” .....	148
Holdings -	
Boat Hook.....	137
Door .....	152
Fishing Pole.....	178 to 181
Ring Buoy.....	137
Hooks -	
Cabin Door .....	151
Coat Hook.....	176
Fender.....	137
Lashing .....	177
Snap .....	137
Utility .....	176
Wardrobe.....	176
Horn, Fog.....	74
Horns for Rowlocks .....	138 and 139
Hull Connections .....	100 to 103
<b>I</b>	
Information -	
Certification of Navigation Lights.....	10
Determining the Hand of a Lock/Latch Set .....	162
Electrical Standards.....	75

## Alphabetic Index

I CONTINUED	PAGE
Emissions Components.....	107 and 124
Light, Vertical Heights .....	www.perko.com
Lock Bevels.....	162
Lock & Latch.....	154 to 171
Representatives .....	5
Sales Policy & Terms.....	4
Searchlights.....	Commercial . 315C
Warranty .....	4
Inlet -	
Check Valves .....	108 and Emissions Cat. 315-E
Fittings for Fresh Water.....	129
Strainer.....	87 to 97
Intake Strainers -	
Clear Body .....	91 and 91
Duplex.....	Commercial Cat. 315C
Flushing.....	88 and 89
Heavy Duty .....	Commercial Cat. 315C
High Capacity .....	94 and 95
Intake .....	87 to 97
Pump .....	97
Round.....	97
Scoop .....	97
Standard.....	92 and 93
<b>K</b>	
Keys, Deck Plate .....	123
Knobs, Drawer.....	171
<b>L</b>	
Lamps -	
Cabin.....	66 to 68
Wall.....	67
Lashing Hooks.....	177
Latches -	
Doors.....	155 to 168
Flush.....	155-160, 163 and 169
Mortise Latch Sets.....	164, 165, and 168
Rim Latch Sets .....	166 and 167
Slam .....	160
Slam Cam Bar .....	153
L.E.D.	

L CONTINUES	PAGE
Deck Lights .....	31
Dome Lights .....	66 to 68
Navigation Lights .....	11 to 62
Utility Lights.....	63 to 65
Light Chart, Vertical Heights .....	www.perko.com
Lights -	
Alpha .....	36 and 47
Arch/Tower .....	34 and 35
All-Round Lights .....	24 to 56
Anchor Lights.....	22-30, 34-56
Bases - Polelights.....	40, 41, 58 and 59
Bass Boat .....	14, 15 and 17
Berth.....	63 to 68
Bi-Color .....	11-15, 23 and 27
Breakdown .....	24 to 30
Coastal Series .....	46
Combination.....	11-15, 23, 27, 31,37-39, and 51
Courtesy.....	63 to 65
Deck .....	31, and 34-39
Delta Series .....	46 and 52
Dredging.....	Commercial Cat. 315C
Dome.....	66 to 68
Flashing .....	Commercial Cat. 315C
Fold Down .....	34-41 and 54
Fold in Half .....	52 and 53
Inland Series.....	48
L.E.D .....	11, 14, 16, 19, 20, 22, 25, .....28, 29, 31, 34, 37, 42, 44, 45, 51, .....52, 53, 55, 63, 64, 65 and 67
Masthead.....	22-33, 37-39, 42, 51
Meal & Absent.....	68
Omega Series .....	45, 52, 53, and 57
Pole .....	14, 15, and 34-59
Range.....	Commercial Cat 315C
Searchlights .....	70-71 and ..... Commercial Cat. 315C
Side.....	16-26, 29 and 30
Spreader.....	31
Stealth Series .....	11, 14, 16, 19, 34, 44, .....52 and 53
Stern .....	22-26, 29, 30, 32-56



# Alphabetic Index

L CONTINUED	PAGE
Telescoping.....	50
Towing.....	22-26, 29 and 30
Tri-Color .....	27 and 38
Utility .....	63 to 65
Vessels under 20 M (65.6 Ft.) in Length.....	11-61
Vessels over 20 M (65.6 Ft.) in Length.....	28-30 & .....Commercial Cat 315C
Line Support Clips .....	85
Locks -	
Compression .....	154
Doors.....	163 to 168
Draw-Down.....	154
Fender.....	137
Flush.....	154 to 159, 163, 169 and 171
Mortise .....	164, 165 and 168
Rim .....	166 and 167
Window .....	175
Lock and Latch Cover.....	158
Locker Ventilators.....	127
Louver Ventilators .....	128
Louver Cockpit Light .....	63
<b>M</b>	
Masthead .....	22-33, 37-39, 42, 51
Meal & Absent .....	68
Mooring Bitts .....	134
<b>N</b>	
Navigation Lights -	
For Vessels:	
Under 20 Meters (65.6 Ft.) in Length.....	11-61
Over 20 Meters (65.6 Ft.) in Length .....	28-30 & .....Commercial Cat 315C
<b>O</b>	
Oar -	
Locks.....	138 and 139
Sockets.....	138 and 139
Omega Series.....	45, 52, 53, and 57
Outlets -	
Cable.....	86

O CONTINUED	PAGE
Water .....	129
<b>P</b>	
P-Traps .....	109
Piano Hinge .....	149
Pipes, Rope, Chain, Deck .....	135
Plates -	
Deck.....	121 & 129
Hawse Hole .....	134
Step .....	135
Plugs, Drain .....	106
Pole Holders - .....	178 to 181
Replacement Bases .....	40, 41 and 57-59
Replacement Poles.....	14, 15, and 34-59
Pole Lights .....	14, 15, and 34-59
Fixed Mount .....	34 to 41
Folding .....	34 to 41
Plug-In .....	14, 15, and 43-59
Pole Lights, Heavy Duty .....	54 and 55
Pole Light Bases .....	40, 41, 58 and 59
Portlight Weatherstripping.....	74
Posts -	
Grab Rail .....	134
Stanchion .....	134
Pressure Relief Fuel Caps.....	124
Prop 65 Warning .....	4
Pulls.....	156, 171 to 174
Drawer.....	171
Pump Strainers.....	97
<b>R</b>	
Rail Fittings.....	134
Replacement Caps .....	124 & 125
Representatives.....	5
Remote Control Searchlights.....	70 and 71
Rigging Tube.....	134
Rim Locks .....	166 and 167
Rim Latches .....	166 and 167
Ring -	
Buoy Holders .....	137

## Alphabetic Index

R CONTINUED	PAGE
Catches, Flush .....	172
Pulls .....	172 and 173
Rings, Hatch Lifting .....	173
Rope -	
Clamps.....	142
Guides.....	142
Springs.....	142
Rowlocks.....	138 and 139
<b>S</b>	
Scuppers -	
Cockpit.....	103 to 105
Thru-Hull.....	103 and 104
In-Line.....	104
Seacocks .....	98
Searchlights -	
Bulbs.....	Commercial Cat. 315-C
Incandescent .....	70 and 71
Remote Control .....	Commercial Cat. 315-C
Spare Parts .....	Commercial Cat. 315-C
Xenon .....	70, Commercial Cat. 315-C
Self Adjusting Slam Latch .....	160
Shield, for Pole or Mast Lights.....	62
Shower Drain.....	104
Shower Latches .....	161
Side Lights .....	16-26, 29 and 30
Snap Hooks.....	137
Sockets -	
Boat Cover.....	177
Sockets.....	57 to 59
Fishing Rod.....	178 to 181
Rowlock.....	138 and 139
Searchlight .....	70 and 71, Commercial Cat. 315-C
Spreader Lights.....	31
Spring Clamps .....	140
Springs for Dock Line .....	142
Steps Boarding.....	135
Stanchion Tubes .....	107
Stern -	
Lights.....	22-26, 29, 30, 32-56
Pole Lights.....	14, 15, and 34-59

S CONTINUED	PAGE
Stops -	
Door .....	152 and 175
Window .....	175
Strainers -	
Clear Body .....	91 and 91
Duplex.....	Commercial Cat 315C
Flushing.....	88 and 89
Heavy Duty .....	Commercial Cat 315C
High Capacity .....	94 and 95
Inlet .....	87 to 97
Intake .....	87 to 97
Pump .....	97
Round.....	97
Scoop .....	97
Standard .....	92 and 93
Thru-Hull.....	97
Water .....	87 to 97
Strap Hinges .....	148
Strap Cable .....	85
Switches -	
Switches.....	75 to 84
Bulkhead Mount .....	81
Cable Spacer.....	83
Compact .....	82
Cup Mount.....	80
Heavy Duty .....	84
Master .....	75 to 84
Medium Duty.....	83
Panel Mount.....	81
Surge Protector.....	107, Emissions Cat. 315-E
Swivel -	
Valves.....	Emissions Cat. 315-E
<b>T</b>	
“T” Hinges .....	148
Table Brackets .....	176
Table Leg Fasteners.....	175
Tank Vent Valves.....	109 to 112
Thru-Hull Connections .....	100 to 106
Tower/Arch Mount Lights .....	34 and 35
Towing Lights .....	22-26, 29 and 30





# Alphabetic Index

T CONTINUED	PAGE
Transom -	
Stern Lights .....	22-26, 29, 30, 32-56
Ventilators .....	126 to 128
Trim, Hatch.....	149
Tube, Rigging .....	134
Tri-Color Lights.....	27 and 38
Turns, Cupboard .....	170
<b>U</b>	
Universal Replacement Pole Light .....	44 to 48
Utility Hooks .....	176
Utility Lights	
Clear Back .....	64
L.E.D.....	63 to 65
Louver.....	63
Red/White .....	63
<b>V</b>	
Valves	
Fuel Limit .....	107 & Emissions Cat. 315-E
Inlet Check .....	108
Pressure Relief.....	107, 124 and ..... Emissions Cat. 315-E
Surge Protector .....	108
Swivel.....	107 & Emissions Cat. 315-E
Tank Vent.....	107 & Emissions Cat. 315-E
Ventilator -	
Clam Shell Type .....	126
Cowl.....	126
Dorade.....	126
Gas Tank.....	109 to 112
Locker .....	127
Louver.....	128
Transom .....	127 and 128
<b>W</b>	
Wardrobe Hooks .....	176
Warranty Information .....	4
Waste Fittings.....	113 to 131
Water Tight Deck Connection.....	86

W	PAGE
Water Strainers.....	87 to 97
Water Strainer Graphs .....	87 to 97
Whistle .....	74
Window -	
Handle, Sliding.....	175
Lock .....	175
Stop.....	175
Windshield Adjusters .....	141
Weatherstripping.....	74

Look for our Complete line of Product Catalogs

## Quality Marine Hardware and Accessories Made in America for Over 100 Years

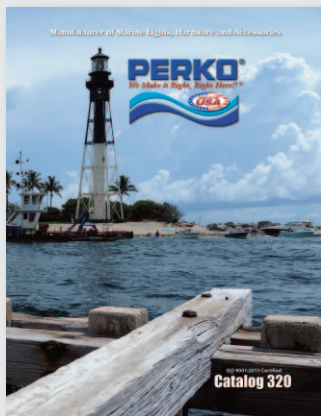

### Catalog 320 For Recreational & Pleasure Boats

- Navigation Lights for Vessels Under 20m
- Battery Switches
- Interior & Utility Lights
- Locks & Latches
- Cabinet Hardware
- Deck Hardware
- Deck Plates, Fills & Caps
- Underwater Hardware
- Underwater Lighting
- Fishing Equipment

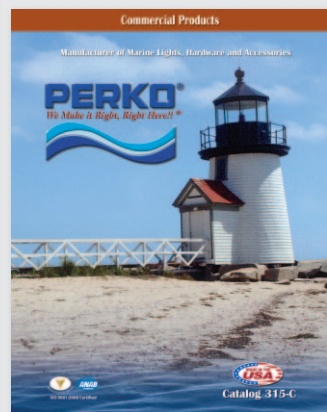

### Catalog 315-C Commercial Products

- Navigation Lights Vessels over 20m
- Searchlights
- Battery Switches
- Interior & Utility Lights
- Cabinet Hardware
- Deck Hardware
- Heavy Duty-Underwater Hardware

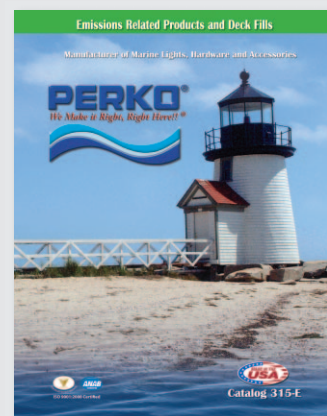

### Catalog 315-E For Emissions Related Products and Deck Fills

- Carbon Canisters
- Fuel Tank Valves
- EPA Compliant Fuel Fills
- Deck Plates & Fills
- Surge Protector
- P-Traps
- Air/Fuel Separator



*Manufacturer of Marine Lights, Hardware and Accessories*

**WE ARE MEMBERS OF THE FOLLOWING ASSOCIATIONS:**

American Boat & Yacht Council, Inc.  
Charter Member  
American Boat & Yacht Council



National Marine  
Manufacturers Association



National Marine Distributors  
Association

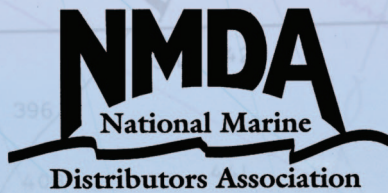

Marine Industries  
Association of South Florida



**PERKO**





  
**PERKO®**  
*We Make it Right, Right Here!!®*



**Manufacturer of Marine Lights, Hardware and Accessories**